

Armor Force Structure Smart Book

Volume I – Regular Army

27 July 2016

Office, Chief of Armor
“Soldiers are our business”

Contents

| | | |
|------------------|---|--------|
| Chapter 1 | Operational Army Structure and Army Training Centers | |
| | Brigade Combat Teams | 1 |
| | Brigade Combat Teams Map | 2 |
| | I Corps | 3 |
| | III Corps | 4 |
| | XVIII ABN Corps | 5 |
| | USAREUR / CTC / MCoE Structure | 6 |
| Chapter 2 | Armored Brigade Combat Team and 11th ACR | |
| | Armored Brigade Combat Team (ABCT) Structure | 7 |
| | Tank Platoon (ABCT) | 8 |
| | Scout Platoon-Combined Arms Battalion (ABCT) | 9 |
| | Scout Platoon-Cavalry Squadron (ABCT) | 10 |
| | Table of Organization (ABCT) | 11, 12 |
| | 11 th Armored Cavalry Regiment (ACR) Structure | 13 |
| | Scout Platoon (11 th ACR) | 14 |
| | Table of Organization (11 th ACR) | 15, 16 |
| Chapter 3 | Stryker Brigade Combat Team | |
| | Stryker Brigade Combat Team (SBCT) Structure | 17 |
| | Mobile Gun System Platoon (SBCT) | 18 |
| | Scout Platoon (SBCT) | 19 |
| | Table of Organization (SBCT) | 20 |
| Chapter 4 | Infantry Brigade Combat Team | |
| | Infantry Brigade Combat Team (IBCT) Structure | 21 |
| | Scout Platoon (IBCT) | 22 |
| | Table of Organization (IBCT) | 23 |
| Chapter 5 | Personnel and Equipment Quick References | |
| | Armor Skill Identifiers..... | 24 |
| | Skill Identifier Positions (MTOE) | 25, 26 |
| | Personnel and Equipment (MTOE) | 27 |
| | Platoon Count | 28 |

Chapter 1

Operational Army Structure and Combat Training Centers



BRIGADE COMBAT TEAMS

ARMOR BRIGADE COMBAT TEAMS (9)



2ABCT, 1AD
FT BLISS TX



3ABCT, 1AD
FT BLISS TX



1ABCT, 1CD
FT HOOD TX



2ABCT, 1CD
FT HOOD TX



3ABCT, 1CD
FT HOOD TX

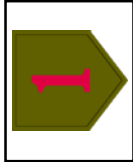

1ABCT, 1ID
FT RILEY KS

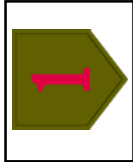

2ABCT, 1ID
FT RILEY KS



1ABCT, 3ID
FT STEWART GA



3ABCT, 4ID
FT CARSON CO

STRYKER BRIGADE COMBAT TEAMS (7)



1SBCT, 1AD
FT BLISS TX



2CR
GERMANY



3CR
FT HOOD TX



1SBCT, 4ID
FT CARSON CO



1SBCT, 7ID
JBLM WA



2SBCT, 7ID
JBLM WA



1SBCT, 25ID
ALASKA

INFANTRY BRIGADE COMBAT TEAMS (15)



1BCT, 101
FT CAMPBELL KY



2BCT, 101
FT CAMPBELL KY



1BCT, 10M
FT DRUM NY



2BCT, 10M
FT DRUM NY



3BCT, 10M
FT POLK LA

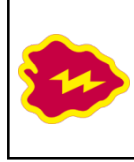

2BCT, 25ID
HAWAII



3BCT, 25ID
HAWAII



4BCT, 25ID
JBER ALASKA



1BCT, 101
FT CAMPBELL KY



2BCT, 101
FT CAMPBELL KY



3BCT, 101
FT CAMPBELL KY



1BCT, 82D
FT BRAGG NC



2BCT, 82D
FT BRAGG NC



3BCT, 82D
FT BRAGG NC



173
ITALY



1-28 INF, 3ID
FT BENNING GA



BN TF



ACR

11ACR
FORT IRWIN CA

Brigade Combat Teams Map

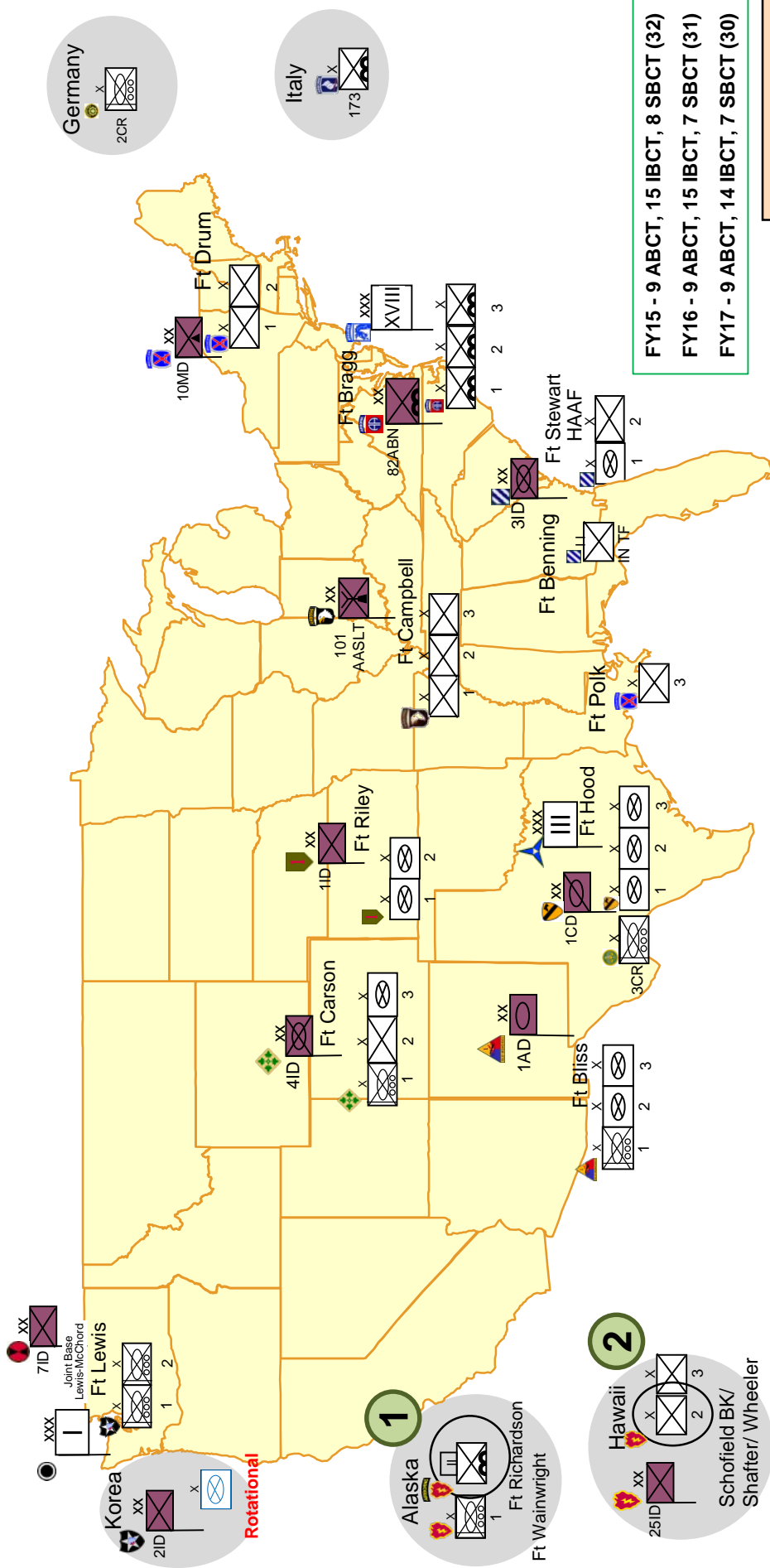

FY15 - 9 ABCT, 15 IBCT, 8 SBCT (32)
 FY16 - 9 ABCT, 15 IBCT, 7 SBCT (31)
 FY17 - 9 ABCT, 14 IBCT, 7 SBCT (30)

BCTs

- Armored BCT
- Infantry BCT
- Infantry BCT (Airborne)
- Stryker BCT

Changes

- Convert 4/25 ID to Airborne Battalion Task Force (Richardson) in FY17 (Pending)
- Convert 2/25 SBCT (Hawaii) to IBCT (2-Battalion) in FY17 (Equipment to ARNG)

* OCONUS two-maneuver battalion design

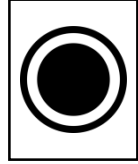

I CORPS
JBLM WA



25th ID
HAWAII

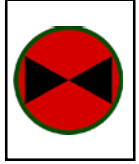

7th ID
JBLM WA



8th ARMY
KOREA



HQs 2nd ID
KOREA



4th IBCT (ABN)
ALASKA



1-40th CAV
AGO



3rd IBCT
HAWAII



3-4th CAV
ALN



2nd IBCT
HAWAII



2-14th CAV
JH8



1st SBCT
ALASKA



3-21st IN
ASM



1-24th IN
H9S



1-5th IN
H9Q



5-1st CAV
JHS



2nd SBCT
JBLM WA



2-1st IN
JML



1-17th IN
JMM



4-23rd IN
JMN



8-1st CAV
JMJ



1st SBCT
JBLM WA



2-3rd IN
JHH



5-20th IN
AJK



1-23rd IN
ARN



1-14th CAV
JHJ

III CORPS

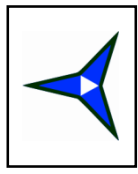

III CORPS
FT HOOD TX



1st AD
FT BLISS TX



1st SBCT
FT BLISS TX



1-36th IN
AE3



3-41st IN
H54



4-17th IN
C1M



6-1st CAV
GKN



2nd ABCT
FT BLISS TX



1-6th IN (CAB)
APS



1-35th AR (CAB)
APY



1-37th AR (CAB)
JZD



1-1st CAV
H5B



3rd ABCT
FT BLISS TX



4-6th IN (CAB)
EZE



1-77th AR (CAB)
AGP



1-67th AR (CAB)
AQ2



2-13th CAV
EZK



1st ABCT
FT HOOD TX



2-5th CAV (CAB)
AGN



2-8th CAV (CAB)
AGR



2-12th CAV (CAB)
H4G



1-7th CAV
AGT



2nd ABCT
FT HOOD TX



1-5th CAV (CAB)
AGL



1-8th CAV (CAB)
AGS



1-9th CAV (CAB)
HNF



4-9th CAV
JHF



3rd ABCT
FT HOOD TX



2-7th CAV (CAB)
ANV



3-8th CAV (CAB)
ADB



1-12th CAV (CAB)
AEO



6-9th CAV
H0J



3rd CAV REGT
FT HOOD TX



1/3 IN
G2L



2/3 IN
G2M



3/3 IN
G2N



4/3 CAV
JWQ

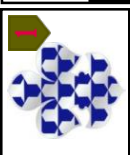

1st ABCT
FT RILEY KS



1-16th IN (CAB)
H9T



2-34th AR (CAB)
AH0



3-66th AR (CAB)
JZB



1-4th CAV
GY7



2nd ABCT
FT RILEY KS



1-18th IN (CAB)
AM4



1-63rd AR (CAB)
AM8



2-70th AR (CAB)
AZB



5-4th CAV
JHB



1st SBCT
FT CARSON CO



4-9th IN
G2G



2-23rd IN
G2H



1-38th IN
G2J



2-1st CAV
H6D



2nd IBCT
FT CARSON CO



3-61st CAV
JL5



3rd ABCT
FT CARSON CO



1-8th IN (CAB)
AKB



1-68th AR (CAB)
AKP



1-66th AR (CAB)
ASH



4-10th CAV
AX6

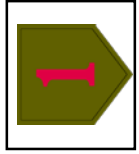

1st ID
FT RILEY KS



4th ID
FT CARSON CO

XVIII AIRBORNE CORPS



XVIII (ABN) CORPS
FT BRAGG NC



3rd ID
FT STEWART GA

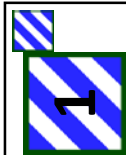

1st ABCT
FT STEWART GA



2-7th IN (CAB)
AQG



3-69th AR (CAB)
AQ1



1-64th AR (CAB)
AZD



5-7th CAV
DMP



10th MTN
FT DRUM NY



1st IBCT
FT DRUM NY



1-71st CAV
JJ2



2nd IBCT
FT DRUM NY



1-89th CAV
JJ3



3rd IBCT
FT POLK LA



3-89th CAV
JKD



1st IBCT (ABN)
FT BRAGG NC



3-73rd CAV
H23



82nd ABN
FT BRAGG NC



2nd IBCT (ABN)
FT BRAGG NC



1-73rd CAV
ASP



3rd IBCT (ABN)
FT BRAGG NC



5-73rd CAV
HPN



1st IBCT (AASLT)
FT CAMPBELL KY



1-32nd CAV
JJZ



101st AASLT
FT CAMPBELL KY



2nd IBCT (AASLT)
FT CAMPBELL KY



1-75th CAV
JU0



3rd IBCT (AASLT)
FT CAMPBELL KY



1-33rd CAV
JJ1

USAREUR



USAREUR
GERMANY

DIRECT
REPORT



173rd (ABN)
ITALY



1-91st CAV
JLP



2nd CAV REGT
GERMANY



1/2 IN
ASF



2/2 IN
FBV



3/2 IN
DA6



4/2 CAV
JHK



NTC
FT IRWIN CA



11th ACR
FT IRWIN CA



1/11 IN
G2C



2/11 IN
G2D

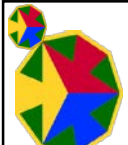

NTC OPS GRP
FT IRWIN CA



TARANTULA
(ABN)



BRONCO



SCORPION



COBRA



1-509th PIR
FT POLK LA
AP4

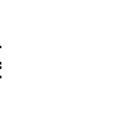

TF1 (IN)
4W6



TF2 (IN)
4W6



TF3 (IN)
4W6



TF4 (RECON)
4W6



JRTC
FT POLK LA



JRTC OPS GRP
FT POLK LA



MUSTANGS (BDE)
W04



WARHOOGS (IN)
W04



TIMBER WOLVES (IN)
W04



PANTHER (IN)
W04



JMTC
GERMANY



JMRC OPS GRP
GERMANY

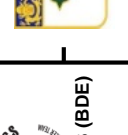

GRIZZLIES (RECON)
W04

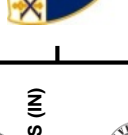

3-353rd (TTC)
6N9

TRAINING CENTERS



MCoE
FT BENNING GA



199th IN BDE
MCE (USAIS)



316th CAV BDE
16R (USAARMS)



2-11 IN (BOLC)
6NF



3-11 IN (OCS)
6NF



2-16 CAV
6NF



3-81 AR
6NF



194th AR BDE
16R (USAARMS)



2-47 IN (BCT)
1DX



1-46 IN (BCT)
1DX



1-81 AR (OSUT)
1DX



5-15 CAV (OSUT)
1DX

Chapter 2

Armored Brigade Combat Team and 11th ACR



Armored Brigade Combat Team

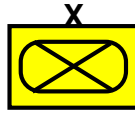

341/42/3799//4182

MCoE SM 3-90
SRC 87312KFC12
2/17/17

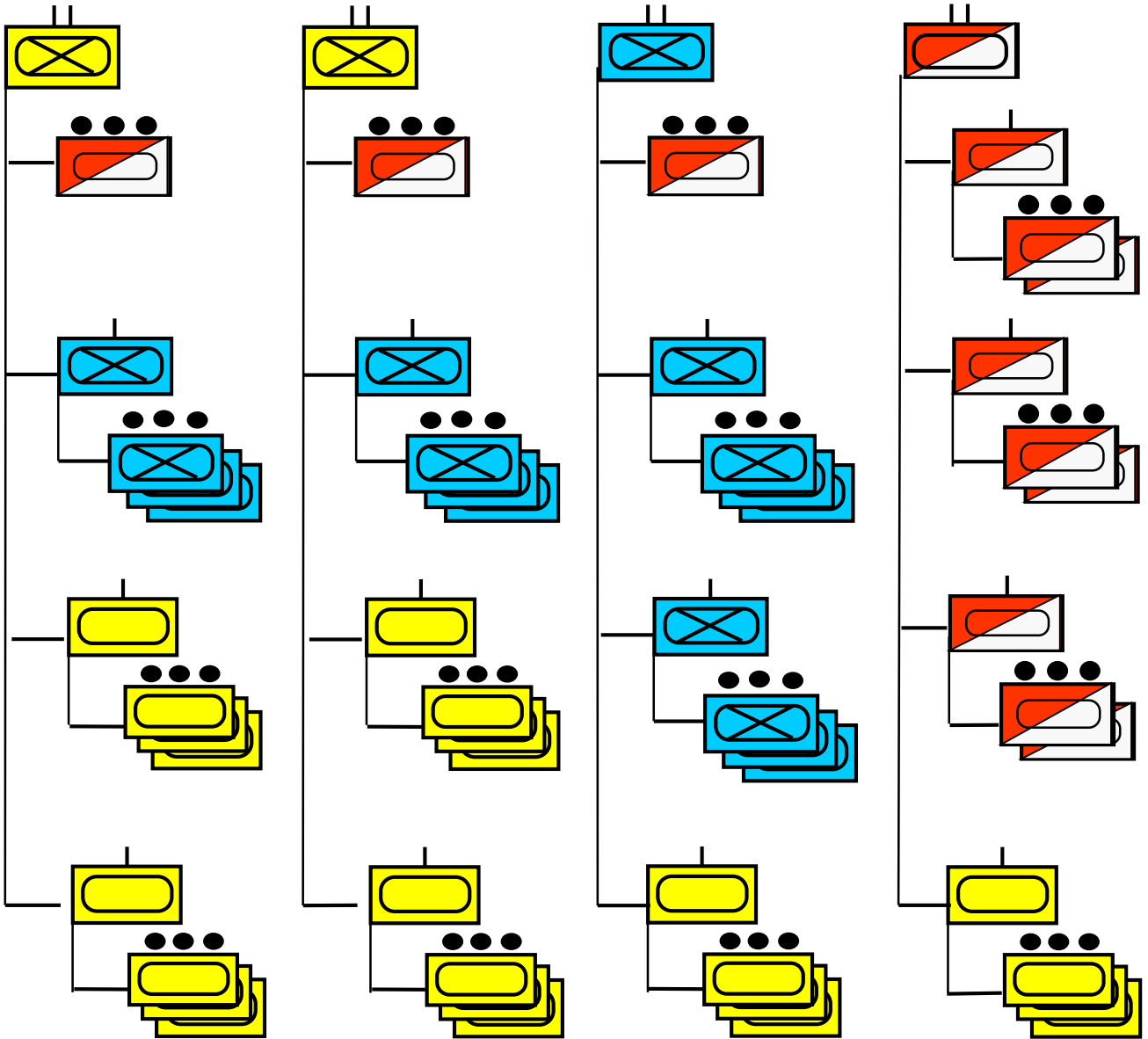

Armored Brigade Combat Team (ABCT)

54 – Armor Companies (45 x CAB; 9 x CAV)

162 -Tank Platoons

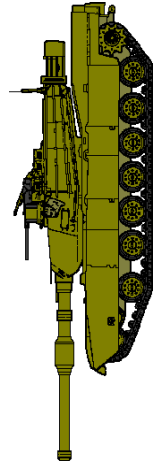
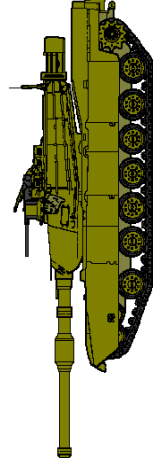
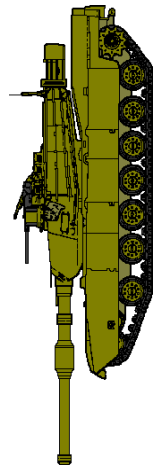
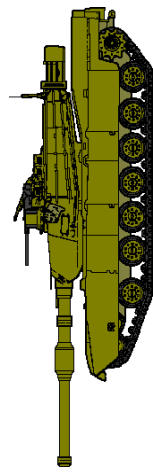

Platoon Leader
19A00 3J



Gunner/
Assistant TC
19K20 K4



Tank Crewman
19K10 K4



Tank Crewman/
Loader
19K10 K4



Platoon Sergeant
19K40 K4



Gunner/
Assistant TC
19K20 K4



Tank Crewman
19K10 K4



Tank Crewman/
Loader
19K10 K4



Tank Commander
19K30 K4



Gunner/
Assistant TC
19K20 K4



Tank Crewman
19K10 K4



Tank Crewman/
Loader
19K10 K4



Tank Commander
19K30 K4



Gunner/
Assistant TC
19K20 K4



Tank Crewman
19K10 K4



Tank Crewman/
Loader
19K10 K4

16 Soldiers, 15 Enlisted (MOS 19K)

Armored Brigade Combat Team (ABCT)

27 – Combined Arms Battalions

27 – Scout Platoons



Platoon Leader
02B00 3X, 5Q, 5R

Platoon Sergeant
19D40 B9, F7, J3

Scout
19D10

Scout
19D10

Scout Driver
19D10

Scout Driver
19D10

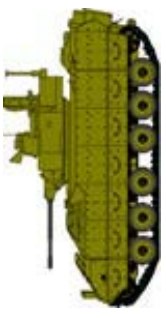

Section Leader
19D30 B9

BFV Gunner
19D20 B9

BFV Driver
19D10 B9

Scout
19D10

Scout
19D10

Scout
19D10



Squad Leader
19D30 F7

Scout
19D10 2C

Scout Driver
19D10

Scout
19D10

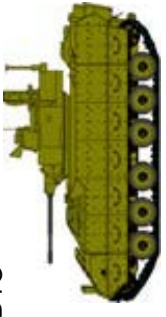

Section Leader
19D30 B9

BFV Gunner
19D20 B9

BFV Driver
19D10 B9

Scout
19D10

Scout
19D10

Scout
19D10

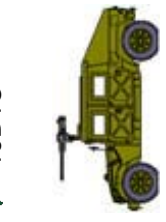

Squad Leader
19D30 F7

Scout
19D10 2C

Scout Driver
19D10

Scout
19D10

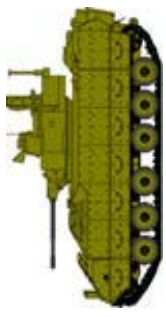

Section Leader
19D30 B9

BFV Gunner
19D20 B9

BFV Driver
19D10 B9

Team Leader
19D20

Scout
19D10

Scout
19D10

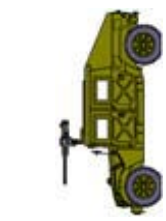

Squad Leader
19D30 F7

Scout
19D10 2C

Scout Driver
19D10

Scout
19D10

Armored Brigade Combat Team (ABCT)

27 – Cavalry Troops 54 – Scout Platoons

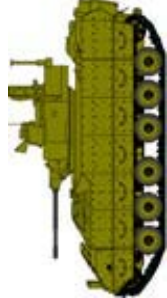
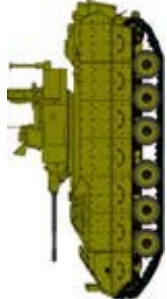
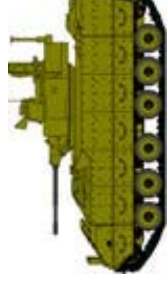
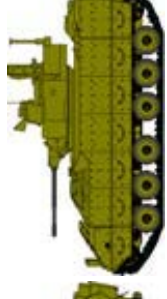
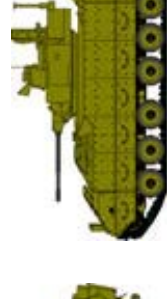
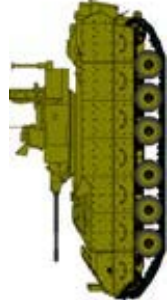

| | | | | | |
|---|---|--|---|---|---|
|  |  |  |  |  |  |
| Platoon Leader 19A00 3X, 5R | Platoon Sergeant 19D40 B9, F7 | Squad Leader 19D30 B9 | Squad Leader 19D3G B9, F7 | Squad Leader 19D30 B9 | Squad Leader 19D3G B9, F7 |
| Team Leader/ CFV Gunner 19D20 B9 | BFV Gunner 19D10 B9 | BFV Gunner 19D10 B9 | BFV Gunner 19D10 B9 | BFV Gunner 19D10 B9 | BFV Gunner 19D10 B9 |
| BFV Driver 19D10 B9 | BFV Driver 19D10 B9 | BFV Driver 19D10 B9 | BFV Driver 19D10 B9 | BFV Driver 19D10 B9 | BFV Driver 19D10 B9 |
| Scout 19D10 2C, B9 | Team Leader 19D20 B9 | Team Leader 19D2G B9 | Team Leader 19D20 B9 | Team Leader 19D2G B9 | Team Leader 19D20 B9 |
| Scout 19D10 B9 | Scout 19D10 B9 | Scout 19D10 2C, B9 | Scout 19D10 B9 | Scout 19D10 2C, B9 | Scout 19D10 B9 |
| Scout 19D10 B9 | Scout 19D10 B9 | Scout 19D10 B9 | Scout 19D10 B9 | Scout 19D10 B9 | Scout 19D10 B9 |

Modified Table of Organization (ABCT)

SRC 87312KFC12 2/17/17

| ABCT BRIGADE HQs | | | | | | | | | | | | | |
|------------------|------------------------|----|---------------------|-------|-------|-----|-----|-----|-------|--------|---------|---------------|----------------|
| PARNO | PARATITLE | LN | TITLE | GRADE | POSCO | AS1 | AS2 | AS3 | BRNCH | REQSTR | AUTHSTR | PARUNITREQSTR | PARUNITAUTHSTR |
| 110 | MVMT AND MANEUVER CELL | 02 | OPERATIONS SERGEANT | E9 | 19260 | 7S | | | NC | 1 | 1 | 1 | 1 |
| 110 | MVMT AND MANEUVER CELL | 03 | MASTER GUNNER | E8 | 19250 | K8 | | | NC | 1 | 1 | 1 | 1 |
| 117 | TAC CUR OPS 1-OPS | 07 | OPERATIONS SERGEANT | E7 | 19K40 | 2S | | | NC | 1 | 1 | 1 | 1 |
| 119 | TAC CUR OPS 2-INTEL/S2 | 02 | SR INTEL SERGEANT | E7 | 19D40 | 2S | | | NC | 1 | 1 | 1 | 1 |
| 122 | COMPANY HEADQUARTERS | 02 | EXECUTIVE OFFICER | O2 | 19A00 | | | | AR | 1 | 1 | 1 | 1 |
| 122 | COMPANY HEADQUARTERS | 03 | FIRST SERGEANT | E8 | 19Z5M | | | | NC | 1 | 1 | 1 | 1 |

| COMBINED ARMS BATTALION (INFANTRY) | | | | | | | | | | | | | |
|------------------------------------|------------------------|----|------------------------|-------|-------|-----|-----|-----|-------|--------|---------|---------------|----------------|
| PARNO | PARATITLE | LN | TITLE | GRADE | POSCO | AS1 | AS2 | AS3 | BRNCH | REQSTR | AUTHSTR | PARUNITREQSTR | PARUNITAUTHSTR |
| 101 | COMMAND GROUP | 04 | GUNNER/ASSISTANT TC | E5 | 19K20 | K4 | | | NC | 1 | 1 | 1 | 1 |
| 101 | COMMAND GROUP | 05 | TANK CREWMAN | E4 | 19K10 | K4 | | | | 1 | 1 | 1 | 1 |
| 101 | COMMAND GROUP | 07 | TANK CREWMAN/LOADER | E3 | 19K10 | K4 | | | | 1 | 1 | 1 | 1 |
| 103 | CURR OPS - OPS/S3 | 09 | MASTER GUNNER | E7 | 19K40 | 2S | K8 | | NC | 1 | 1 | 1 | 1 |
| 113 | SCOUT PLATOON HEADQUAR | 02 | PLATOON SERGEANT | E7 | 19D40 | B9 | F7 | J3 | NC | 1 | 1 | 1 | 1 |
| 113 | SCOUT PLATOON HEADQUAR | 03 | SCOUT DRIVER | E4 | 19D10 | | | | | 2 | 2 | 2 | 2 |
| 113 | SCOUT PLATOON HEADQUAR | 04 | SCOUT | E3 | 19D10 | | | | | 2 | 2 | 2 | 2 |
| 114 | SCOUT SECTION | 01 | SECTION LEADER | E6 | 19D30 | B9 | | | NC | 2 | 2 | 2 | 2 |
| 114 | SCOUT SECTION | 02 | SQUAD LEADER | E6 | 19D30 | F7 | | | NC | 2 | 2 | 2 | 2 |
| 114 | SCOUT SECTION | 03 | BFV GUNNER | E5 | 19D20 | B9 | | | NC | 2 | 2 | 2 | 2 |
| 114 | SCOUT SECTION | 04 | SCOUT | E4 | 19D10 | | | | | 2 | 2 | 2 | 2 |
| 114 | SCOUT SECTION | 05 | SCOUT | E4 | 19D10 | 2C | | | | 2 | 2 | 2 | 2 |
| 114 | SCOUT SECTION | 06 | BFV DRIVER | E4 | 19D10 | B9 | | | | 2 | 2 | 2 | 2 |
| 114 | SCOUT SECTION | 07 | SCOUT DRIVER | E4 | 19D10 | | | | | 2 | 2 | 2 | 2 |
| 114 | SCOUT SECTION | 08 | SCOUT | E3 | 19D10 | | | | | 6 | 6 | 6 | 6 |
| 115 | SCOUT SECTION | 01 | SECTION LEADER | E6 | 19D30 | B9 | | | NC | 1 | 1 | 1 | 1 |
| 115 | SCOUT SECTION | 02 | SQUAD LEADER | E6 | 19D30 | F7 | | | NC | 1 | 1 | 1 | 1 |
| 115 | SCOUT SECTION | 03 | TEAM LEADER | E5 | 19D20 | | | | NC | 1 | 1 | 1 | 1 |
| 115 | SCOUT SECTION | 04 | BFV GUNNER | E5 | 19D20 | B9 | | | NC | 1 | 1 | 1 | 1 |
| 115 | SCOUT SECTION | 05 | SCOUT | E4 | 19D10 | 2C | | | | 1 | 1 | 1 | 1 |
| 115 | SCOUT SECTION | 06 | BFV DRIVER | E4 | 19D10 | B9 | | | | 1 | 1 | 1 | 1 |
| 115 | SCOUT SECTION | 07 | SCOUT DRIVER | E4 | 19D10 | | | | | 1 | 1 | 1 | 1 |
| 115 | SCOUT SECTION | 08 | SCOUT | E3 | 19D10 | | | | | 3 | 3 | 3 | 3 |
| 124 | MINE ROLLER SECTION | 01 | HEAVY VEHICLE DRIVER | E4 | 19K10 | K4 | | | | 1 | 1 | 1 | 1 |
| 301 | COMPANY HEADQUARTERS | 01 | COMMANDER | O3 | 19A00 | 3J | | | AR | 1 | 1 | 1 | 1 |
| 301 | COMPANY HEADQUARTERS | 02 | EXECUTIVE OFFICER | O2 | 19A00 | 3J | | | AR | 1 | 1 | 1 | 1 |
| 301 | COMPANY HEADQUARTERS | 03 | FIRST SERGEANT | E8 | 19Z5M | | | | NC | 1 | 1 | 1 | 1 |
| 301 | COMPANY HEADQUARTERS | 04 | TANK CDR/MASTER GUNNER | E6 | 19K30 | K8 | | | NC | 1 | 1 | 1 | 1 |
| 301 | COMPANY HEADQUARTERS | 05 | GUNNER/ASSISTANT TC | E5 | 19K20 | K4 | | | NC | 2 | 2 | 2 | 2 |
| 301 | COMPANY HEADQUARTERS | 08 | CARRIER DRIVER | E4 | 19K10 | K4 | | | | 1 | 1 | 1 | 1 |
| 301 | COMPANY HEADQUARTERS | 09 | TANK CREWMAN | E4 | 19K10 | K4 | | | | 2 | 2 | 2 | 2 |
| 301 | COMPANY HEADQUARTERS | 11 | TANK CREWMAN/LOADER | E3 | 19K10 | K4 | | | | 2 | 2 | 2 | 2 |
| 302 | TANK PLATOON | 01 | PLATOON LEADER | O2 | 19A00 | 3J | | | AR | 3 | 3 | 3 | 3 |
| 302 | TANK PLATOON | 02 | PLATOON SERGEANT | E7 | 19K40 | K4 | | | NC | 3 | 3 | 3 | 3 |
| 302 | TANK PLATOON | 03 | TANK COMMANDER | E6 | 19K30 | K4 | | | NC | 6 | 6 | 6 | 6 |
| 302 | TANK PLATOON | 04 | GUNNER/ASSISTANT TC | E5 | 19K20 | K4 | | | NC | 12 | 12 | 12 | 12 |
| 302 | TANK PLATOON | 05 | TANK CREWMAN | E4 | 19K10 | K4 | | | | 12 | 12 | 12 | 12 |
| 302 | TANK PLATOON | 06 | TANK CREWMAN/LOADER | E3 | 19K10 | K4 | | | | 12 | 12 | 12 | 12 |

| COMBINED ARMS BATTALION (ARMOR) | | | | | | | | | | | | | |
|---------------------------------|------------------------|----|------------------------|-------|-------|-----|-----|-----|-------|--------|---------|---------------|----------------|
| PARNO | PARATITLE | LN | TITLE | GRADE | POSCO | AS1 | AS2 | AS3 | BRNCH | REQSTR | AUTHSTR | PARUNITREQSTR | PARUNITAUTHSTR |
| 101 | COMMAND GROUP | 04 | GUNNER/ASSISTANT TC | E5 | 19K20 | K4 | | | NC | 1 | 1 | 1 | 1 |
| 101 | COMMAND GROUP | 05 | TANK CREWMAN | E4 | 19K10 | K4 | | | | 1 | 1 | 1 | 1 |
| 101 | COMMAND GROUP | 07 | TANK CREWMAN/LOADER | E3 | 19K10 | K4 | | | | 1 | 1 | 1 | 1 |
| 103 | CURR OPS - OPS/S3 | 09 | MASTER GUNNER | E7 | 19K40 | 2S | K8 | | NC | 1 | 1 | 1 | 1 |
| 113 | SCOUT PLATOON HEADQUAR | 02 | PLATOON SERGEANT | E7 | 19D40 | B9 | F7 | J3 | NC | 1 | 1 | 1 | 1 |
| 113 | SCOUT PLATOON HEADQUAR | 03 | SCOUT DRIVER | E4 | 19D10 | | | | | 2 | 2 | 2 | 2 |
| 113 | SCOUT PLATOON HEADQUAR | 04 | SCOUT | E3 | 19D10 | | | | | 2 | 2 | 2 | 2 |
| 114 | SCOUT SECTION | 01 | SECTION LEADER | E6 | 19D30 | B9 | | | NC | 2 | 2 | 2 | 2 |
| 114 | SCOUT SECTION | 02 | SQUAD LEADER | E6 | 19D30 | F7 | | | NC | 2 | 2 | 2 | 2 |
| 114 | SCOUT SECTION | 03 | BFV GUNNER | E5 | 19D20 | B9 | | | NC | 2 | 2 | 2 | 2 |
| 114 | SCOUT SECTION | 04 | SCOUT | E4 | 19D10 | | | | | 2 | 2 | 2 | 2 |
| 114 | SCOUT SECTION | 05 | SCOUT | E4 | 19D10 | 2C | | | | 2 | 2 | 2 | 2 |
| 114 | SCOUT SECTION | 06 | BFV DRIVER | E4 | 19D10 | B9 | | | | 2 | 2 | 2 | 2 |
| 114 | SCOUT SECTION | 07 | SCOUT DRIVER | E4 | 19D10 | | | | | 2 | 2 | 2 | 2 |
| 114 | SCOUT SECTION | 08 | SCOUT | E3 | 19D10 | | | | | 6 | 6 | 6 | 6 |
| 115 | SCOUT SECTION | 01 | SECTION LEADER | E6 | 19D30 | B9 | | | NC | 1 | 1 | 1 | 1 |
| 115 | SCOUT SECTION | 02 | SQUAD LEADER | E6 | 19D30 | F7 | | | NC | 1 | 1 | 1 | 1 |
| 115 | SCOUT SECTION | 03 | TEAM LEADER | E5 | 19D20 | | | | NC | 1 | 1 | 1 | 1 |
| 115 | SCOUT SECTION | 04 | BFV GUNNER | E5 | 19D20 | B9 | | | NC | 1 | 1 | 1 | 1 |
| 115 | SCOUT SECTION | 05 | SCOUT | E4 | 19D10 | 2C | | | | 1 | 1 | 1 | 1 |
| 115 | SCOUT SECTION | 06 | BFV DRIVER | E4 | 19D10 | B9 | | | | 1 | 1 | 1 | 1 |
| 115 | SCOUT SECTION | 07 | SCOUT DRIVER | E4 | 19D10 | | | | | 1 | 1 | 1 | 1 |
| 115 | SCOUT SECTION | 08 | SCOUT | E3 | 19D10 | | | | | 3 | 3 | 3 | 3 |
| 124 | MINE ROLLER SECTION | 01 | HEAVY VEHICLE DRIVER | E4 | 19K10 | K4 | | | | 1 | 1 | 1 | 1 |
| 124 | MINE ROLLER SECTION | 02 | ASST HEAVY VEH DRIVER | E3 | 19K10 | K4 | | | | 1 | 1 | 1 | 1 |
| 201 | COMPANY HEADQUARTERS | 01 | COMMANDER | O3 | 19A00 | 3J | | | AR | 1 | 1 | 2 | 2 |
| 201 | COMPANY HEADQUARTERS | 02 | EXECUTIVE OFFICER | O2 | 19A00 | 3J | | | AR | 1 | 1 | 2 | 2 |
| 201 | COMPANY HEADQUARTERS | 03 | FIRST SERGEANT | E8 | 19Z5M | | | | NC | 1 | 1 | 2 | 2 |
| 201 | COMPANY HEADQUARTERS | 04 | TANK CDR/MASTER GUNNER | E6 | 19K30 | K8 | | | NC | 1 | 1 | 2 | 2 |
| 201 | COMPANY HEADQUARTERS | 05 | GUNNER/ASSISTANT TC | E5 | 19K20 | K4 | | | NC | 2 | 2 | 4 | 4 |
| 201 | COMPANY HEADQUARTERS | 08 | CARRIER DRIVER | E4 | 19K10 | K4 | | | | 1 | 1 | 2 | 2 |
| 201 | COMPANY HEADQUARTERS | 09 | TANK CREWMAN | E4 | 19K10 | K4 | | | | 2 | 2 | 4 | 4 |
| 201 | COMPANY HEADQUARTERS | 11 | TANK CREWMAN/LOADER | E3 | 19K10 | K4 | | | | 2 | 2 | 4 | 4 |
| 202 | TANK PLATOON | 01 | PLATOON LEADER | O2 | 19A00 | 3J | | | AR | 3 | 3 | 6 | 6 |
| 202 | TANK PLATOON | 02 | PLATOON SERGEANT | E7 | 19K40 | K4 | | | NC | 3 | 3 | 6 | 6 |
| 202 | TANK PLATOON | 03 | TANK COMMANDER | E6 | 19K30 | K4 | | | NC | 6 | 6 | 12 | 12 |
| 202 | TANK PLATOON | 04 | GUNNER/ASSISTANT TC | E5 | 19K20 | K4 | | | NC | 12 | 12 | 24 | 24 |
| 202 | TANK PLATOON | 05 | TANK CREWMAN | E4 | 19K10 | K4 | | | | 12 | 12 | 24 | 24 |
| 202 | TANK PLATOON | 06 | TANK CREWMAN/LOADER | E3 | 19K10 | K4 | | | | 12 | 12 | 24 | 24 |

| CAVALRY SQUADRON | | | | | | | | | | | | | |
|------------------|------------------------|----|------------------------|-------|-------|------|------|------|-------|--------|---------|---------------|----------------|
| PARNO | PARATITLE | LN | TITLE | GRADE | POSCO | AS11 | AS12 | AS13 | BRNCH | REQSTR | AUTHSTR | PARUNITREQSTR | PARUNITAUTHSTR |
| 101 | COMMAND GROUP | 03 | COMMAND SERGEANT MAJOR | E9 | 19Z6O | 6C | | | NC | 1 | 1 | 1 | 1 |
| 101 | COMMAND GROUP | 04 | VEHICLE COMMANDER | E6 | 19D3O | B9 | | | NC | 1 | 1 | 1 | 1 |
| 101 | COMMAND GROUP | 05 | BFV GUNNER | E5 | 19D2O | B9 | | | NC | 1 | 1 | 1 | 1 |
| 101 | COMMAND GROUP | 06 | BFV DRIVER | E4 | 19D1O | B9 | | | | 1 | 1 | 1 | 1 |
| 101 | COMMAND GROUP | 07 | VEHICLE DRIVER | E3 | 19D1O | | | | | 1 | 1 | 1 | 1 |
| 103 | CURR OPS - OPS/S3 | 02 | PLANS OFFICER | O3 | 19A0O | | | | AR | 1 | 1 | 1 | 1 |
| 103 | CURR OPS - OPS/S3 | 03 | ASSISTANT S3 | O3 | 19A0O | 3S | | | AR | 1 | 1 | 1 | 1 |
| 103 | CURR OPS - OPS/S3 | 04 | ASSISTANT S3 | O3 | 19A0O | 3S | S7 | | AR | 1 | 1 | 1 | 1 |
| 103 | CURR OPS - OPS/S3 | 06 | OPERATIONS SERGEANT | E9 | 19Z6O | 6S | | | NC | 1 | 1 | 1 | 1 |
| 103 | CURR OPS - OPS/S3 | 07 | ASST OPERATIONS SGT | E7 | 19D4O | 2S | J3 | | NC | 1 | 1 | 1 | 1 |
| 103 | CURR OPS - OPS/S3 | 08 | ASST OPERATIONS SGT | E7 | 19D4O | 2S | | | NC | 1 | 1 | 1 | 1 |
| 103 | CURR OPS - OPS/S3 | 09 | MASTER GUNNER | E7 | 19K4O | 2S | K8 | | NC | 1 | 1 | 1 | 1 |
| 103 | CURR OPS - OPS/S3 | 10 | VEHICLE COMMANDER | E6 | 19D3O | B9 | | | NC | 1 | 1 | 1 | 1 |
| 103 | CURR OPS - OPS/S3 | 12 | CARRIER DRIVER | E4 | 19D1O | | | | | 1 | 1 | 1 | 1 |
| 103 | CURR OPS - OPS/S3 | 13 | BFV DRIVER | E4 | 19D1O | B9 | | | | 1 | 1 | 1 | 1 |
| 107 | SUSTAINMENT-S4 | 01 | S4 | O3 | 19A0O | | | | AR | 1 | 1 | 1 | 1 |
| 107 | SUSTAINMENT-S4 | 02 | SQUADRON MAINTENANCE O | O3 | 19A0O | | | | AR | 1 | 1 | 1 | 1 |
| 111 | TROOP HEADQUARTERS | 01 | COMMANDER | O3 | 19A0O | | | | AR | 1 | 1 | 1 | 1 |
| 111 | TROOP HEADQUARTERS | 02 | EXECUTIVE OFFICER | O2 | 19A0O | | | | AR | 1 | 1 | 1 | 1 |
| 111 | TROOP HEADQUARTERS | 03 | FIRST SERGEANT | E8 | 19Z5M | | | | NC | 1 | 1 | 1 | 1 |
| 116 | MINE ROLLER SECTION | 01 | HEAVY VEHICLE DRIVER | E4 | 19K1O | K4 | | | | 1 | 1 | 1 | 1 |
| 201 | TROOP HEADQUARTERS | 01 | COMMANDER | O3 | 19A0O | 3X | | | AR | 1 | 1 | 3 | 3 |
| 201 | TROOP HEADQUARTERS | 02 | EXECUTIVE OFFICER | O2 | 19A0O | | | | AR | 1 | 1 | 3 | 3 |
| 201 | TROOP HEADQUARTERS | 03 | FIRST SERGEANT | E8 | 19Z5M | | | | NC | 1 | 1 | 3 | 3 |
| 201 | TROOP HEADQUARTERS | 04 | OPERATIONS NCO | E6 | 19D3O | J3 | | | NC | 1 | 1 | 3 | 3 |
| 201 | TROOP HEADQUARTERS | 05 | BFV GUNNER | E5 | 19D2O | B9 | | | NC | 1 | 1 | 3 | 3 |
| 201 | TROOP HEADQUARTERS | 09 | CARRIER DRIVER | E4 | 19D1O | | | | | 2 | 2 | 6 | 6 |
| 201 | TROOP HEADQUARTERS | 10 | BFV DRIVER | E4 | 19D1O | B9 | | | | 1 | 1 | 3 | 3 |
| 203 | SCOUT PLATOON HEADQUAR | 01 | PLATOON LEADER | O2 | 19A0O | 3X | 5R | | AR | 2 | 2 | 6 | 6 |
| 203 | SCOUT PLATOON HEADQUAR | 02 | PLATOON SERGEANT | E7 | 19D4O | B9 | F7 | | NC | 2 | 2 | 6 | 6 |
| 203 | SCOUT PLATOON HEADQUAR | 03 | TEAM LEADER | E5 | 19D2O | B9 | | | NC | 2 | 2 | 6 | 6 |
| 203 | SCOUT PLATOON HEADQUAR | 04 | TM LDR/CFV GUNNER | E5 | 19D2O | B9 | | | NC | 2 | 2 | 6 | 6 |
| 203 | SCOUT PLATOON HEADQUAR | 05 | SCOUT | E4 | 19D1O | 2C | B9 | | | 2 | 2 | 6 | 6 |
| 203 | SCOUT PLATOON HEADQUAR | 06 | SCOUT | E4 | 19D1O | B9 | | | | 4 | 4 | 12 | 12 |
| 203 | SCOUT PLATOON HEADQUAR | 07 | BFV GUNNER | E4 | 19D1O | B9 | | | | 2 | 2 | 6 | 6 |
| 203 | SCOUT PLATOON HEADQUAR | 08 | SCOUT | E3 | 19D1O | B9 | | | | 4 | 4 | 12 | 12 |
| 203 | SCOUT PLATOON HEADQUAR | 09 | BFV DRIVER | E3 | 19D1O | B9 | | | | 4 | 4 | 12 | 12 |
| 204 | SCOUT SECTION | 01 | SQUAD LEADER | E6 | 19D3G | B9 | F7 | | NC | 4 | 4 | 12 | 12 |
| 204 | SCOUT SECTION | 02 | SQUAD LEADER | E6 | 19D3O | B9 | | | NC | 4 | 4 | 12 | 12 |
| 204 | SCOUT SECTION | 03 | TEAM LEADER | E5 | 19D2G | B9 | | | NC | 4 | 4 | 12 | 12 |
| 204 | SCOUT SECTION | 04 | TEAM LEADER | E5 | 19D2O | B9 | | | NC | 4 | 4 | 12 | 12 |
| 204 | SCOUT SECTION | 05 | SCOUT | E4 | 19D1O | B9 | | | | 4 | 4 | 12 | 12 |
| 204 | SCOUT SECTION | 06 | SCOUT | E4 | 19D1O | 2C | B9 | | | 4 | 4 | 12 | 12 |
| 204 | SCOUT SECTION | 07 | BFV GUNNER | E4 | 19D1O | B9 | | | | 8 | 8 | 24 | 24 |
| 204 | SCOUT SECTION | 08 | SCOUT | E3 | 19D1O | B9 | | | | 8 | 8 | 24 | 24 |
| 204 | SCOUT SECTION | 09 | BFV DRIVER | E3 | 19D1O | B9 | | | | 8 | 8 | 24 | 24 |
| 301 | COMPANY HEADQUARTERS | 01 | COMMANDER | O3 | 19A0O | 3J | | | AR | 1 | 1 | 1 | 1 |
| 301 | COMPANY HEADQUARTERS | 02 | EXECUTIVE OFFICER | O2 | 19A0O | 3J | | | AR | 1 | 1 | 1 | 1 |
| 301 | COMPANY HEADQUARTERS | 03 | FIRST SERGEANT | E8 | 19Z5M | | | | NC | 1 | 1 | 1 | 1 |
| 301 | COMPANY HEADQUARTERS | 04 | TANK CDR/MASTER GUNNER | E6 | 19K3O | K8 | | | NC | 1 | 1 | 1 | 1 |
| 301 | COMPANY HEADQUARTERS | 05 | GUNNER/ASSISTANT TC | E5 | 19K2O | K4 | | | NC | 2 | 2 | 2 | 2 |
| 301 | COMPANY HEADQUARTERS | 08 | CARRIER DRIVER | E4 | 19K1O | K4 | | | | 1 | 1 | 1 | 1 |
| 301 | COMPANY HEADQUARTERS | 09 | TANK CREWMAN | E4 | 19K1O | K4 | | | | 2 | 2 | 2 | 2 |
| 301 | COMPANY HEADQUARTERS | 11 | TANK CREWMAN/LOADER | E3 | 19K1O | K4 | | | | 2 | 2 | 2 | 2 |
| 302 | TANK PLATOON | 01 | PLATOON LEADER | O2 | 19A0O | 3J | | | AR | 3 | 3 | 3 | 3 |
| 302 | TANK PLATOON | 02 | PLATOON SERGEANT | E7 | 19K4O | K4 | | | NC | 3 | 3 | 3 | 3 |
| 302 | TANK PLATOON | 03 | TANK COMMANDER | E6 | 19K3O | K4 | | | NC | 6 | 6 | 6 | 6 |
| 302 | TANK PLATOON | 04 | GUNNER/ASSISTANT TC | E5 | 19K2O | K4 | | | NC | 12 | 12 | 12 | 12 |
| 302 | TANK PLATOON | 05 | TANK CREWMAN | E4 | 19K1O | K4 | | | | 12 | 12 | 12 | 12 |
| 302 | TANK PLATOON | 06 | TANK CREWMAN/LOADER | E3 | 19K1O | K4 | | | | 12 | 12 | 12 | 12 |

11th Armored Cavalry Regiment

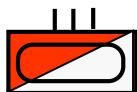

237/25/3132//3394

SRC 87102LFC01

10/17/16

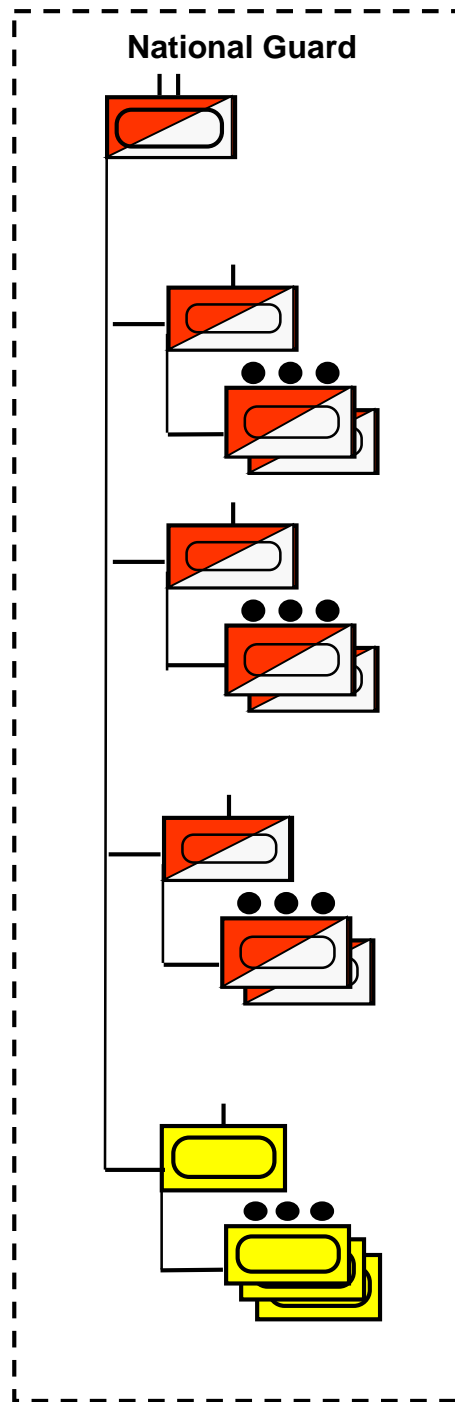
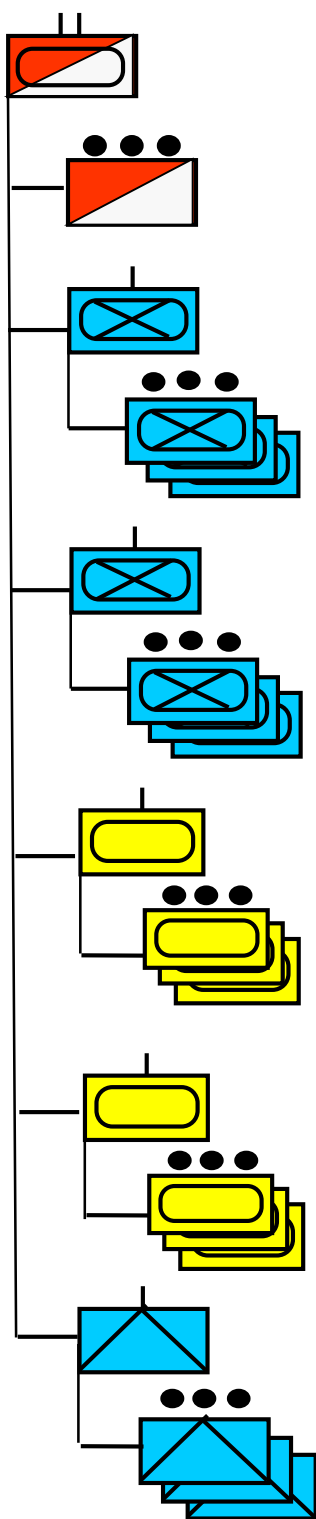
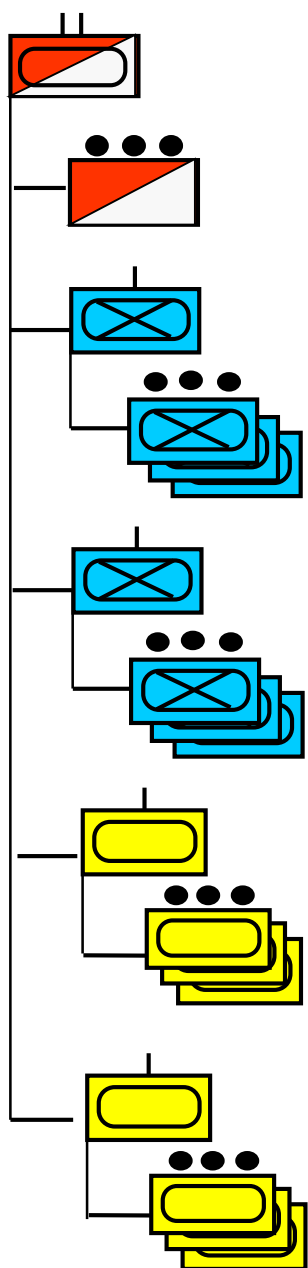

11th Armored Cavalry Regiment

2 – Scout Platoons

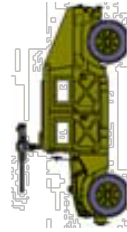

Platoon Leader
19A00 5R



Scout
19D10



Scout Driver
19D10

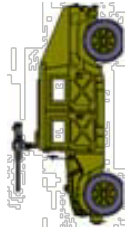

Section Leader
19D30



Team Leader
19D20



Scout Driver
19D10 2C

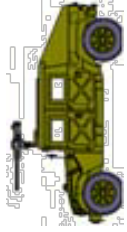

Squad Leader
19D20



Scout
19D10 2C



Scout Driver
19D10

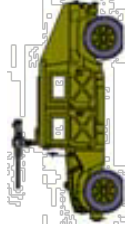

Section Leader
19D30



Team Leader
19D20



Scout Driver
19D10 2C

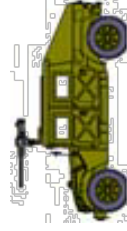

Squad Leader
19D20



Scout
19D10 2C



Scout Driver
19D10

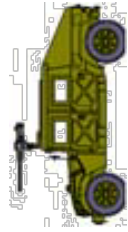

Platoon Sergeant
19D40 F7



Scout
19D10



Scout Driver
19D10

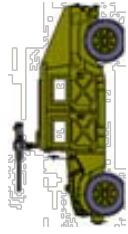

Section Leader
19D30



Scout
19D10



Scout Driver
19D10 2C

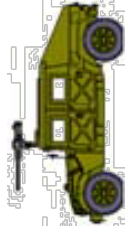

Squad Leader
19D20



Scout
19D10 2C



Scout Driver
19D10

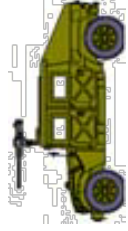

Section Leader
19D30



Scout
19D10



Scout Driver
19D10 2C

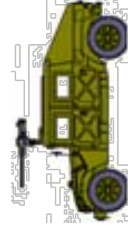

Squad Leader
19D20



Scout
19D10 2C



Scout Driver
19D10

| 11TH ACR REGIMENTAL HQs | | | | | | | | | | | | | |
|-------------------------|------------------------|----|------------------------|-------|-------|------|------|------|-------|--------|---------|---------------|----------------|
| PARN0 | PARATITLE | LN | TITLE | GRADE | POSCO | AS11 | AS12 | AS13 | BRNCH | REQSTR | AUTHSTR | PARUNITREQSTR | PARUNITAUTHSTR |
| 101 | COMMAND SECTION | 02 | DEPUTY COMMANDER | O6 | 19A00 | | | | AR | 1 | 1 | 1 | 1 |
| 101 | COMMAND SECTION | 06 | AIDE-DE-CAMP | O2 | 02A00 | | | | CI | 0 | 0 | 0 | 0 |
| 101 | COMMAND SECTION | 07 | COMMAND SERGEANT MAJOR | E9 | 00T60 | 7C | | | NC | 1 | 1 | 1 | 1 |
| 101 | COMMAND SECTION | 09 | CARRIER DRIVER | E4 | 19K10 | | | | | 1 | 1 | 1 | 1 |
| 101 | COMMAND SECTION | 11 | VEHICLE DRIVER | E3 | 19K10 | | | | | 1 | 1 | 1 | 1 |
| 102 | EXECUTIVE OFFICER SECT | 02 | LIAISON OFFICER | O3 | 19A00 | | | | AR | 2 | 2 | 2 | 2 |
| 102 | EXECUTIVE OFFICER SECT | 04 | VEHICLE DRIVER | E3 | 19K10 | | | | | 1 | 1 | 1 | 1 |
| 104 | S2 SECTION | 05 | INTEL SERGEANT | E7 | 19D40 | 2S | | | NC | 1 | 1 | 1 | 1 |
| 105 | S3 SECTION | 01 | S3 | O4 | 19A00 | | | | AR | 1 | 1 | 1 | 1 |
| 105 | S3 SECTION | 02 | S3 AIR | O3 | 19A00 | 3S | | | AR | 1 | 1 | 1 | 1 |
| 105 | S3 SECTION | 03 | PLANS OFFICER | O3 | 19A00 | | | | AR | 1 | 1 | 1 | 1 |
| 105 | S3 SECTION | 06 | ASSISTANT S3 AIR | O3 | 19A00 | 3S | 5A | | AR | 1 | 1 | 1 | 1 |
| 105 | S3 SECTION | 09 | OPERATIONS SERGEANT | E9 | 19Z60 | 7S | | | NC | 1 | 1 | 1 | 1 |
| 105 | S3 SECTION | 11 | ASST OPERATIONS SGT | E7 | 19K40 | 2S | | | NC | 2 | 2 | 2 | 2 |
| 105 | S3 SECTION | 12 | MASTER GUNNER | E7 | 19K40 | A8 | | | NC | 1 | 1 | 1 | 1 |
| 105 | S3 SECTION | 14 | OPERATIONS ASSISTANT | E5 | 19D20 | | | | NC | 1 | 1 | 1 | 1 |
| 105 | S3 SECTION | 15 | CARRIER DRIVER | E4 | 19K10 | | | | | 3 | 3 | 3 | 3 |
| 105 | S3 SECTION | 17 | VEHICLE DRIVER | E3 | 19K10 | | | | | 1 | 1 | 1 | 1 |
| 106 | SUSTAINMENT-S4 | 10 | CARRIER DRIVER | E4 | 19K10 | | | | | 1 | 1 | 1 | 1 |
| 125 | COMPANY HEADQUARTERS | 01 | COMMANDER | O4 | 02A00 | | | | CI | 1 | 1 | 1 | 1 |
| 125 | COMPANY HEADQUARTERS | 02 | EXECUTIVE OFFICER | O2 | 02A00 | | | | CI | 1 | 1 | 1 | 1 |
| 125 | COMPANY HEADQUARTERS | 03 | FIRST SERGEANT | E8 | 19Z5M | | | | NC | 1 | 1 | 1 | 1 |

1ST SQUADRON

| PARN0 | PARATITLE | LN | TITLE | GRADE | POSCO | AS11 | AS12 | AS13 | BRNCH | REQSTR | AUTHSTR | PARUNITREQSTR | PARUNITAUTHSTR |
|-------|------------------------|----|------------------------|-------|-------|------|------|------|-------|--------|---------|---------------|----------------|
| 101 | COMMAND SECTION | 01 | COMMANDER | O5 | 19A00 | 3J | | | AR | 1 | 1 | 1 | 1 |
| 101 | COMMAND SECTION | 02 | EXECUTIVE OFFICER | O4 | 19A00 | | | | AR | 1 | 1 | 1 | 1 |
| 101 | COMMAND SECTION | 03 | COMMAND SERGEANT MAJOR | E9 | 19Z60 | 6C | | | NC | 1 | 1 | 1 | 1 |
| 101 | COMMAND SECTION | 04 | TANK COMMANDER | E7 | 19K40 | | | | NC | 1 | 1 | 1 | 1 |
| 101 | COMMAND SECTION | 05 | GUNNER/ASSISTANT TC | E5 | 19K20 | | | | NC | 1 | 1 | 1 | 1 |
| 101 | COMMAND SECTION | 06 | TANK CREWMAN | E4 | 19K10 | | | | | 1 | 1 | 1 | 1 |
| 101 | COMMAND SECTION | 07 | VEHICLE DRIVER | E3 | 19K10 | | | | | 2 | 2 | 2 | 2 |
| 101 | COMMAND SECTION | 08 | TANK CREWMAN/LOADER | E3 | 19K10 | | | | | 1 | 1 | 1 | 1 |
| 103 | S2 SECTION | 03 | SR INTEL SERGEANT | E7 | 19D40 | 2S | | | NC | 1 | 1 | 1 | 1 |
| 104 | S3 SECTION | 01 | S3 | O4 | 19A00 | 3J | | | AR | 1 | 1 | 1 | 1 |
| 104 | S3 SECTION | 03 | S3 AIR | O3 | 19A00 | 3J | 3S | 5U | AR | 1 | 1 | 1 | 1 |
| 104 | S3 SECTION | 04 | LIAISON OFFICER | O2 | 19A00 | 3J | | | AR | 1 | 1 | 1 | 1 |
| 104 | S3 SECTION | 06 | OPERATIONS SERGEANT | E9 | 19Z60 | 6S | | | NC | 1 | 1 | 1 | 1 |
| 104 | S3 SECTION | 07 | ASST OPERATIONS SGT | E7 | 19K40 | 2S | K4 | | NC | 1 | 1 | 1 | 1 |
| 104 | S3 SECTION | 08 | MASTER GUNNER | E7 | 19K40 | 2S | K8 | | NC | 1 | 1 | 1 | 1 |
| 104 | S3 SECTION | 10 | OPERATIONS ASSISTANT | E5 | 19K20 | K4 | | | NC | 1 | 1 | 1 | 1 |
| 104 | S3 SECTION | 11 | GUNNER/ASSISTANT TC | E5 | 19K20 | K4 | | | NC | 1 | 1 | 1 | 1 |
| 104 | S3 SECTION | 12 | TANK COMMANDER | E5 | 19K20 | K4 | | | NC | 1 | 1 | 1 | 1 |
| 104 | S3 SECTION | 13 | CARRIER DRIVER | E4 | 19K10 | K4 | | | | 2 | 2 | 2 | 2 |
| 104 | S3 SECTION | 14 | LIAISON ASSISTANT | E4 | 19K10 | K4 | | | | 1 | 1 | 1 | 1 |
| 104 | S3 SECTION | 15 | TANK CREWMAN | E4 | 19K10 | K4 | | | | 1 | 1 | 1 | 1 |
| 104 | S3 SECTION | 16 | VEHICLE DRIVER | E3 | 19K10 | K4 | | | | 1 | 1 | 1 | 1 |
| 104 | S3 SECTION | 17 | TANK CREWMAN/LOADER | E3 | 19K10 | K4 | | | | 1 | 1 | 1 | 1 |
| 105 | S4 SECTION | 01 | S4 | O3 | 19A00 | 3J | | | AR | 1 | 1 | 1 | 1 |
| 105 | S4 SECTION | 03 | CARRIER DRIVER | E4 | 19K10 | K4 | | | | 1 | 1 | 1 | 1 |
| 106 | COMPANY HEADQUARTERS | 01 | COMMANDER | O3 | 19A00 | 3J | | | AR | 1 | 1 | 1 | 1 |
| 106 | COMPANY HEADQUARTERS | 02 | EXECUTIVE OFFICER | O2 | 19A00 | 3J | | | AR | 1 | 1 | 1 | 1 |
| 106 | COMPANY HEADQUARTERS | 03 | FIRST SERGEANT | E8 | 19Z5M | | | | NC | 1 | 1 | 1 | 1 |
| 106 | COMPANY HEADQUARTERS | 06 | VEHICLE DRIVER | E3 | 19K10 | K4 | | | | 1 | 1 | 1 | 1 |
| 106 | COMPANY HEADQUARTERS | 07 | VEHICLE DRIVER | E3 | 19K10 | K4 | | | | 2 | 2 | 2 | 2 |
| 108 | SCOUT PLATOON HEADQUAR | 01 | PLATOON LEADER | O2 | 19A00 | 5R | | | AR | 1 | 1 | 1 | 1 |
| 108 | SCOUT PLATOON HEADQUAR | 02 | PLATOON SERGEANT | E7 | 19D40 | F7 | | | NC | 1 | 1 | 1 | 1 |
| 108 | SCOUT PLATOON HEADQUAR | 03 | SCOUT DRIVER | E4 | 19D10 | | | | | 2 | 2 | 2 | 2 |
| 108 | SCOUT PLATOON HEADQUAR | 04 | SCOUT | E3 | 19D10 | | | | | 2 | 2 | 2 | 2 |
| 109 | SCOUT SECTION | 01 | SECTION LEADER | E6 | 19D30 | | | | NC | 2 | 2 | 2 | 2 |
| 109 | SCOUT SECTION | 02 | TEAM LEADER | E5 | 19D20 | | | | NC | 2 | 2 | 2 | 2 |
| 109 | SCOUT SECTION | 03 | SQUAD LEADER | E5 | 19D20 | | | | NC | 2 | 2 | 2 | 2 |
| 109 | SCOUT SECTION | 04 | SCOUT DRIVER | E4 | 19D10 | | | | | 2 | 2 | 2 | 2 |
| 109 | SCOUT SECTION | 05 | SCOUT DRIVER | E4 | 19D10 | 2C | | | | 2 | 2 | 2 | 2 |
| 109 | SCOUT SECTION | 06 | SCOUT | E3 | 19D10 | 2C | | | | 2 | 2 | 2 | 2 |
| 110 | SCOUT SECTION | 01 | SECTION LEADER | E6 | 19D30 | | | | NC | 2 | 2 | 2 | 2 |
| 110 | SCOUT SECTION | 02 | SQUAD LEADER | E5 | 19D20 | | | | NC | 2 | 2 | 2 | 2 |
| 110 | SCOUT SECTION | 03 | SCOUT DRIVER | E4 | 19D10 | | | | | 2 | 2 | 2 | 2 |
| 110 | SCOUT SECTION | 04 | SCOUT DRIVER | E4 | 19D10 | 2C | | | | 2 | 2 | 2 | 2 |
| 110 | SCOUT SECTION | 05 | SCOUT | E3 | 19D10 | | | | | 2 | 2 | 2 | 2 |
| 110 | SCOUT SECTION | 06 | SCOUT | E3 | 19D10 | 2C | | | | 2 | 2 | 2 | 2 |
| 111 | HEAVY MORTAR PLATOON H | 01 | PLATOON LEADER | O2 | 19A00 | 3J | 3Z | | AR | 1 | 1 | 1 | 1 |
| 114 | BATTALION SUPPORT PLAT | 01 | PLATOON LEADER | O2 | 19A00 | 3J | | | AR | 1 | 1 | 1 | 1 |
| 114 | BATTALION SUPPORT PLAT | 03 | VEHICLE DRIVER | E3 | 19K10 | K4 | | | | 1 | 1 | 1 | 1 |
| 115 | TRANSPORTATION SECTION | 03 | AMMUNITION SERGEANT | E5 | 19K20 | K4 | | | NC | 1 | 1 | 1 | 1 |
| 115 | TRANSPORTATION SECTION | 06 | ASST HEAVY VEH DRIVER | E4 | 19K10 | K4 | | | | 1 | 1 | 1 | 1 |
| 115 | TRANSPORTATION SECTION | 07 | ASST VEHICLE DRIVER | E4 | 19K10 | K4 | | | | 1 | 1 | 1 | 1 |
| 115 | TRANSPORTATION SECTION | 13 | ASST HEAVY VEH DRIVER | E3 | 19K10 | K4 | | | | 1 | 1 | 1 | 1 |
| 115 | TRANSPORTATION SECTION | 14 | ASST VEHICLE DRIVER | E3 | 19K10 | K4 | | | | 2 | 2 | 2 | 2 |
| 116 | TANK CO CLASS III/V SQ | 04 | ASST HEAVY VEH DRIVER | E4 | 19K10 | K4 | | | | 4 | 4 | 4 | 4 |
| 116 | TANK CO CLASS III/V SQ | 07 | ASST HEAVY VEH DRIVER | E3 | 19K10 | K4 | | | | 2 | 2 | 2 | 2 |
| 123 | BATTALION MAINTENANCE | 01 | MAINTENANCE OFFICER | O3 | 19A00 | 3J | | | AR | 1 | 1 | 1 | 1 |
| 301 | COMPANY HEADQUARTERS | 01 | COMMANDER | O3 | 19A00 | 3J | | | AR | 1 | 1 | 2 | 2 |
| 301 | COMPANY HEADQUARTERS | 02 | EXECUTIVE OFFICER | O2 | 19A00 | 3J | | | AR | 1 | 1 | 2 | 2 |
| 301 | COMPANY HEADQUARTERS | 03 | FIRST SERGEANT | E8 | 19Z5M | | | | NC | 1 | 1 | 2 | 2 |
| 301 | COMPANY HEADQUARTERS | 04 | TANK CDR/MASTER GUNNER | E6 | 19K30 | K8 | | | NC | 1 | 1 | 2 | 2 |
| 301 | COMPANY HEADQUARTERS | 05 | GUNNER/ASSISTANT TC | E5 | 19K20 | K4 | | | NC | 2 | 2 | 4 | 4 |
| 301 | COMPANY HEADQUARTERS | 08 | CARRIER DRIVER | E4 | 19K10 | K4 | | | | 1 | 1 | 2 | 2 |
| 301 | COMPANY HEADQUARTERS | 09 | GUNNER | E4 | 19K10 | K4 | | | | 1 | 1 | 2 | 2 |
| 301 | COMPANY HEADQUARTERS | 10 | TANK CREWMAN | E4 | 19K10 | K4 | | | | 2 | 2 | 4 | 4 |
| 301 | COMPANY HEADQUARTERS | 12 | TANK CREWMAN/LOADER | E3 | 19K10 | K4 | | | | 2 | 2 | 4 | 4 |
| 302 | TANK PLATOON | 01 | PLATOON LEADER | O2 | 19A00 | 3J | | | AR | 3 | 3 | 6 | 6 |
| 302 | TANK PLATOON | 02 | PLATOON SERGEANT | E7 | 19K40 | K4 | | | NC | 3 | 3 | 6 | 6 |
| 302 | TANK PLATOON | 03 | TANK COMMANDER | E6 | 19K30 | K4 | | | NC | 6 | 6 | 12 | 12 |
| 302 | TANK PLATOON | 04 | GUNNER/ASSISTANT TC | E5 | 19K20 | K4 | | | NC | 12 | 12 | 24 | 24 |
| 302 | TANK PLATOON | 05 | TANK CREWMAN | E4 | 19K10 | K4 | | | | 12 | 12 | 24 | 24 |
| 302 | TANK PLATOON | 06 | TANK CREWMAN/LOADER | E3 | 19K10 | K4 | | | | 12 | 12 | 24 | 24 |

| 2ND SQUADRON | | | | | | | | | | | | | |
|--------------|------------------------|----|------------------------|-------|-------|------|------|------|-------|--------|---------|---------------|----------------|
| PARNO | PARATITLE | LN | TITLE | GRADE | POSCO | ASI1 | ASI2 | ASI3 | BRNCH | REQSTR | AUTHSTR | PARUNITREQSTR | PARUNITAUTHSTR |
| 108 | SCOUT PLATOON HEADQUAR | 01 | PLATOON LEADER | O2 | 11A00 | 3X | 5R | | IN | 1 | 1 | 1 | 1 |
| 108 | SCOUT PLATOON HEADQUAR | 02 | PLATOON SERGEANT | E7 | 19D40 | F7 | | | NC | 1 | 1 | 1 | 1 |
| 108 | SCOUT PLATOON HEADQUAR | 03 | TEAM LEADER | E5 | 19D20 | | | | NC | 1 | 1 | 1 | 1 |
| 108 | SCOUT PLATOON HEADQUAR | 04 | SCOUT DRIVER | E4 | 19D10 | 2C | | | | 2 | 2 | 2 | 2 |
| 108 | SCOUT PLATOON HEADQUAR | 05 | SCOUT | E3 | 19D10 | 2C | | | | 1 | 1 | 1 | 1 |
| 109 | SCOUT SECTION | 01 | SECTION LEADER | E6 | 19D30 | | | | NC | 2 | 2 | 2 | 2 |
| 109 | SCOUT SECTION | 02 | TEAM LEADER | E5 | 19D20 | | | | NC | 2 | 2 | 2 | 2 |
| 109 | SCOUT SECTION | 03 | SQUAD LEADER | E5 | 19D20 | | | | NC | 2 | 2 | 2 | 2 |
| 109 | SCOUT SECTION | 04 | SCOUT DRIVER | E4 | 19D20 | | | | | 2 | 2 | 2 | 2 |
| 109 | SCOUT SECTION | 05 | SCOUT DRIVER | E4 | 19D10 | 2C | | | | 2 | 2 | 2 | 2 |
| 109 | SCOUT SECTION | 06 | SCOUT | E3 | 19D10 | 2C | | | | 2 | 2 | 2 | 2 |
| 110 | SCOUT SECTION | 01 | SECTION LEADER | E6 | 19D30 | | | | NC | 2 | 2 | 2 | 2 |
| 110 | SCOUT SECTION | 02 | SQUAD LEADER | E5 | 19D20 | | | | NC | 2 | 2 | 2 | 2 |
| 110 | SCOUT SECTION | 03 | SCOUT DRIVER | E4 | 19D10 | | | | | 2 | 2 | 2 | 2 |
| 110 | SCOUT SECTION | 04 | SCOUT DRIVER | E4 | 19D10 | 2C | | | | 2 | 2 | 2 | 2 |
| 110 | SCOUT SECTION | 05 | SCOUT | E3 | 19D10 | | | | | 2 | 2 | 2 | 2 |
| 110 | SCOUT SECTION | 06 | SCOUT | E3 | 19D10 | 2C | | | | 2 | 2 | 2 | 2 |
| 117 | TANK CO CLASS III/V SQ | 04 | ASST HEAVY VEH DRIVER | E4 | 19K10 | K4 | | | | 4 | 4 | 4 | 4 |
| 117 | TANK CO CLASS III/V SQ | 07 | ASST HEAVY VEH DRIVER | E3 | 19K10 | K4 | | | | 2 | 2 | 2 | 2 |
| 301 | COMPANY HEADQUARTERS | 01 | COMMANDER | O3 | 19A00 | 3J | | | AR | 1 | 1 | 2 | 2 |
| 301 | COMPANY HEADQUARTERS | 02 | EXECUTIVE OFFICER | O2 | 19A00 | 3J | | | AR | 1 | 1 | 2 | 2 |
| 301 | COMPANY HEADQUARTERS | 03 | FIRST SERGEANT | E8 | 19Z5M | | | | NC | 1 | 1 | 2 | 2 |
| 301 | COMPANY HEADQUARTERS | 04 | TANK CDR/MASTER GUNNER | E6 | 19K30 | K8 | | | NC | 1 | 1 | 2 | 2 |
| 301 | COMPANY HEADQUARTERS | 05 | GUNNER/ASSISTANT TC | E5 | 19K20 | K4 | | | NC | 2 | 2 | 4 | 4 |
| 301 | COMPANY HEADQUARTERS | 08 | CARRIER DRIVER | E4 | 19K10 | K4 | | | | 1 | 1 | 2 | 2 |
| 301 | COMPANY HEADQUARTERS | 09 | GUNNER | E4 | 19K10 | K4 | | | | 1 | 1 | 2 | 2 |
| 301 | COMPANY HEADQUARTERS | 10 | TANK CREWMAN | E4 | 19K10 | K4 | | | | 2 | 2 | 4 | 4 |
| 301 | COMPANY HEADQUARTERS | 12 | TANK CREWMAN/LOADER | E3 | 19K10 | K4 | | | | 2 | 2 | 4 | 4 |
| 302 | TANK PLATOON | 01 | PLATOON LEADER | O2 | 19A00 | 3J | | | AR | 3 | 3 | 6 | 6 |
| 302 | TANK PLATOON | 02 | PLATOON SERGEANT | E7 | 19K40 | K4 | | | NC | 3 | 3 | 6 | 6 |
| 302 | TANK PLATOON | 03 | TANK COMMANDER | E6 | 19K30 | K4 | | | NC | 6 | 6 | 12 | 12 |
| 302 | TANK PLATOON | 04 | GUNNER/ASSISTANT TC | E5 | 19K20 | K4 | | | NC | 12 | 12 | 24 | 24 |
| 302 | TANK PLATOON | 05 | TANK CREWMAN | E4 | 19K10 | K4 | | | | 12 | 12 | 24 | 24 |
| 302 | TANK PLATOON | 06 | TANK CREWMAN/LOADER | E3 | 19K10 | K4 | | | | 12 | 12 | 24 | 24 |

Chapter 3

Stryker Brigade Combat Team



Stryker Brigade Combat Team



X

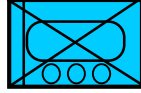

334/42/4001//4377

MCoE SM 3-90
SRC 47112KE102
9/17/16

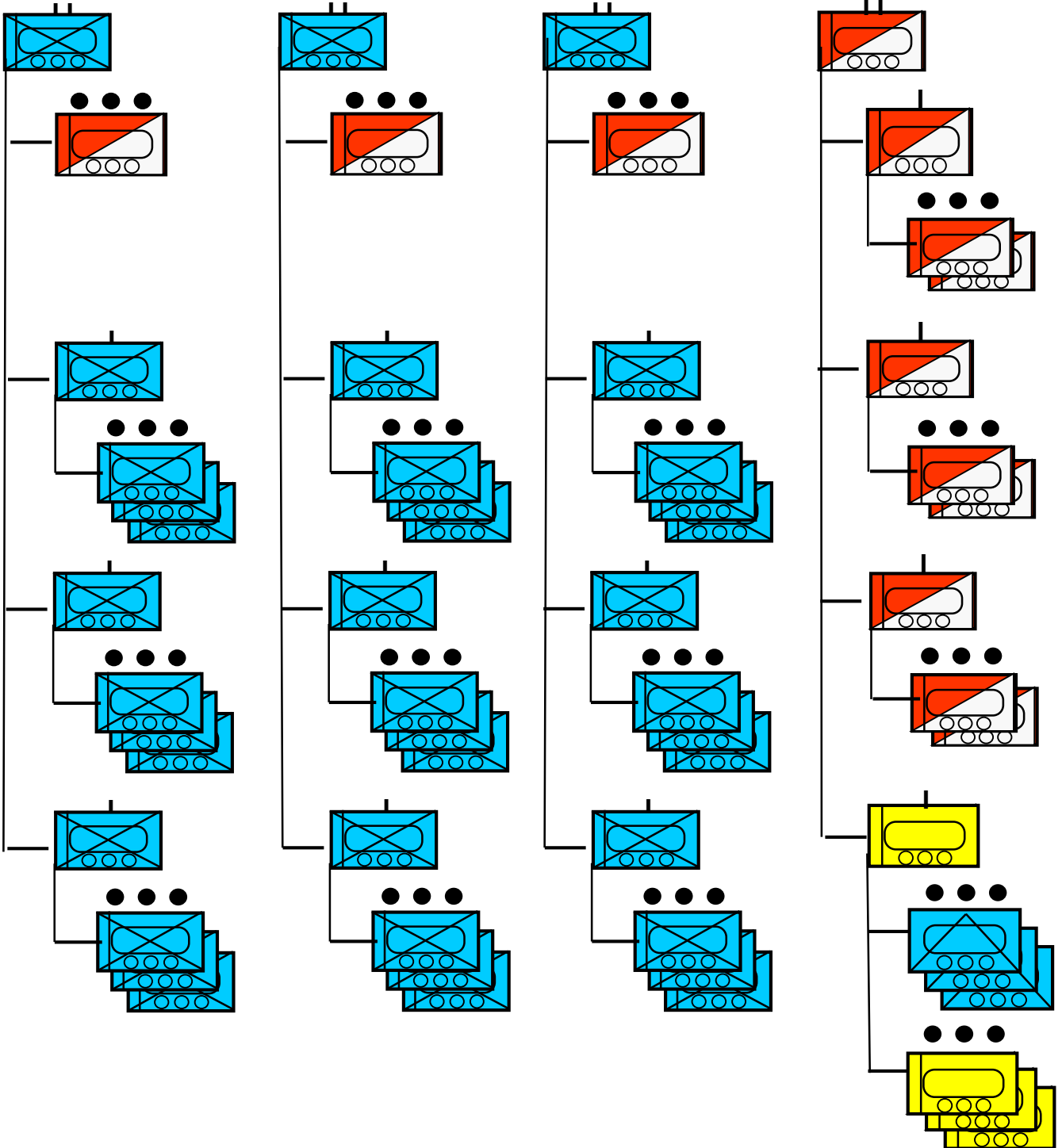

Stryker Brigade Combat Team (SBCT)

7 – Weapons Troops 21 – MGS Platoons

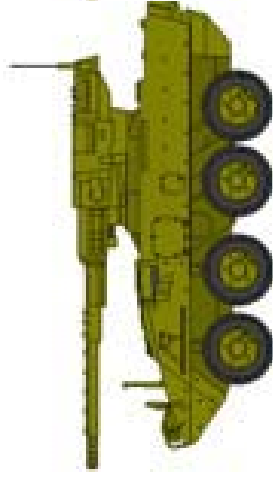

Platoon Leader
19A00 R4



MGS Gunner
19D20 R4



MGS Driver
19D10 R4

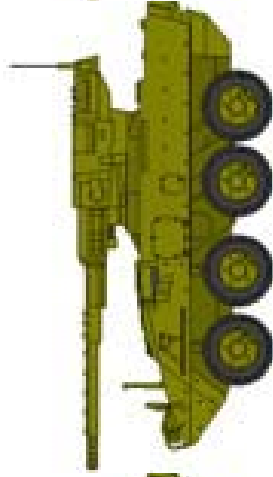

Platoon Sergeant
19D40 R4



MGS Gunner
19D20 R4



MGS Driver
19D10 R4

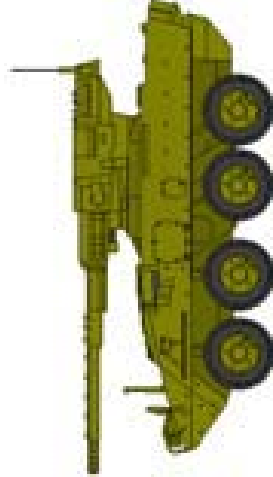

MGS Commander
19D30 R4



MGS Gunner
19D20 R4



MGS Driver
19D10 R4

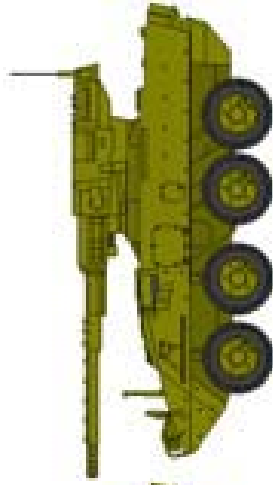

MGS Commander
19D30 R8



MGS Gunner
19D20 R4









MGS Driver
19D10 R4

Stryker Brigade Combat Team (SBCT)

21 – Cavalry Troops

63 – Scout Platoons (42 x CAV, 21 x SIB)



| | | | | | |
|---|---|---|---|---|---|
|  |  |  |  |  |  |
| Platoon Leader 19A00 5R, R4 | Platoon Sergeant 19D40 F7, R4 | Squad Leader 19D30 F7, R4 | Squad Leader 19D30 F7, R4 | Squad Leader 19D30 F7, R4 | Squad Leader 19D30 F7, R4 |
|  |  |  |  |  |  |
| Stryker Gunner 19D10 R4 | Stryker Gunner 19D10 R4 | Stryker Gunner 19D10 R4 | Stryker Gunner 19D10 R4 | Stryker Gunner 19D10 R4 | Stryker Gunner 19D10 R4 |
|  |  |  |  |  |  |
| Stryker Driver 19D10 R4 | Stryker Driver 19D10 R4 | Stryker Driver 19D10 R4 | Stryker Driver 19D10 R4 | Stryker Driver 19D10 R4 | Stryker Driver 19D10 R4 |
|  |  |  |  |  |  |
| Team Leader 19D2G R4 | Team Leader 19D20 R4 | Team Leader 19D2G R4 | Team Leader 19D20 R4 | Team Leader 19D2G R4 | Team Leader 19D20 R4 |
|  |  |  |  |  |  |
| Scout 19D10 2C, R4 | Scout 19D10 R4 | Scout 19D10 2C, R4 | Scout 19D10 R4 | Scout 19D10 2C, R4 | Scout 19D10 R4 |
|  |  |  |  |  |  |
| Scout 19D10 R4 | Scout 19D10 R4 | Scout 19D10 R4 | Scout 19D10 R4 | Scout 19D10 R4 | Scout 19D10 R4 |

Modified Table of Organization (SBCT) SRC 47112KE102 9/17/16

| SBCT BRIGADE HQS | | | | | | | | | | | | | |
|----------------------------|------------------------|----|------------------------|-------|-------|------|------|------|-------|--------|---------|---------------|----------------|
| PARNO | PARATITLE | LN | TITLE | GRADE | POSCO | AS11 | AS12 | AS13 | BRNCH | REQSTR | AUTHSTR | PARUNITREQSTR | PARUNITAUTHSTR |
| 110 | MVMT AND MANEUVER CELL | 03 | ASST OPERATIONS SGT | E7 | 19D40 | | | | NC | 1 | 1 | 1 | 1 |
| 117 | TAC CUR OPS 1-OPS | 07 | ASST OPERATIONS SGT | E7 | 19D40 | | | | NC | 1 | 1 | 1 | 1 |
| STRYKER INFANTRY BATTALION | | | | | | | | | | | | | |
| 113 | SCOUT PLATOON HEADQUAR | 02 | PLATOON SERGEANT | E7 | 19D40 | F7 | R4 | | NC | 1 | 1 | 1 | 1 |
| 113 | SCOUT PLATOON HEADQUAR | 03 | TEAM LEADER | E5 | 19D2G | R4 | | | NC | 1 | 1 | 1 | 1 |
| 113 | SCOUT PLATOON HEADQUAR | 04 | TEAM LEADER | E5 | 19D20 | R4 | | | NC | 1 | 1 | 1 | 1 |
| 113 | SCOUT PLATOON HEADQUAR | 05 | SCOUT | E4 | 19D10 | R4 | | | | 1 | 1 | 1 | 1 |
| 113 | SCOUT PLATOON HEADQUAR | 06 | SCOUT | E4 | 19D10 | 2C | R4 | | | 1 | 1 | 1 | 1 |
| 113 | SCOUT PLATOON HEADQUAR | 07 | SCOUT GUNNER | E4 | 19D10 | R4 | | | | 2 | 2 | 2 | 2 |
| 113 | SCOUT PLATOON HEADQUAR | 08 | SCOUT | E3 | 19D10 | R4 | | | | 2 | 2 | 2 | 2 |
| 113 | SCOUT PLATOON HEADQUAR | 09 | SCOUT DRIVER | E3 | 19D10 | R4 | | | | 2 | 2 | 2 | 2 |
| 114 | SCOUT SECTION | 01 | SQUAD LEADER | E6 | 19D3G | F7 | R4 | | NC | 2 | 2 | 2 | 2 |
| 114 | SCOUT SECTION | 02 | SQUAD LEADER | E6 | 19D30 | R4 | | | NC | 2 | 2 | 2 | 2 |
| 114 | SCOUT SECTION | 03 | TEAM LEADER | E5 | 19D2G | R4 | | | NC | 2 | 2 | 2 | 2 |
| 114 | SCOUT SECTION | 04 | TEAM LEADER | E5 | 19D20 | R4 | | | NC | 2 | 2 | 2 | 2 |
| 114 | SCOUT SECTION | 05 | SCOUT | E4 | 19D10 | R4 | | | | 2 | 2 | 2 | 2 |
| 114 | SCOUT SECTION | 06 | SCOUT | E4 | 19D10 | 2C | R4 | | | 2 | 2 | 2 | 2 |
| 114 | SCOUT SECTION | 07 | SCOUT GUNNER | E4 | 19D10 | R4 | | | | 4 | 4 | 4 | 4 |
| 114 | SCOUT SECTION | 08 | SCOUT | E3 | 19D10 | R4 | | | | 4 | 4 | 4 | 4 |
| 114 | SCOUT SECTION | 09 | SCOUT DRIVER | E3 | 19D10 | R4 | | | | 4 | 4 | 4 | 4 |
| CAVALRY SQUADRON | | | | | | | | | | | | | |
| PARNO | PARATITLE | LN | TITLE | GRADE | POSCO | AS11 | AS12 | AS13 | BRNCH | REQSTR | AUTHSTR | PARUNITREQSTR | PARUNITAUTHSTR |
| 101 | COMMAND GROUP | 03 | COMMAND SERGEANT MAJOR | E9 | 19Z60 | 6C | | | NC | 1 | 1 | 1 | 1 |
| 101 | COMMAND GROUP | 04 | STRYKER COMMANDER | E5 | 19D20 | R4 | | | NC | 1 | 1 | 1 | 1 |
| 101 | COMMAND GROUP | 05 | STRYKER DRIVER | E4 | 19D10 | R4 | | | | 1 | 1 | 1 | 1 |
| 101 | COMMAND GROUP | 06 | VEHICLE DRIVER | E3 | 19D10 | | | | | 1 | 1 | 1 | 1 |
| 103 | CURR OPS - OPS/S3 | 02 | ASSISTANT S3 | O3 | 19A00 | 3S | R4 | | AR | 1 | 1 | 1 | 1 |
| 103 | CURR OPS - OPS/S3 | 03 | ASSISTANT S3 | O3 | 19A00 | R4 | S7 | | AR | 1 | 1 | 1 | 1 |
| 103 | CURR OPS - OPS/S3 | 04 | OPERATIONS SERGEANT | E9 | 19Z60 | 6S | | | NC | 1 | 1 | 1 | 1 |
| 103 | CURR OPS - OPS/S3 | 05 | ASST OPERATIONS SGT | E7 | 19D40 | 2S | R4 | | NC | 1 | 1 | 1 | 1 |
| 103 | CURR OPS - OPS/S3 | 06 | ASST OPERATIONS SGT | E7 | 19D40 | 2S | R4 | | NC | 1 | 1 | 1 | 1 |
| 103 | CURR OPS - OPS/S3 | 07 | ASST OPERATIONS SGT | E7 | 19D40 | | | | NC | 1 | 1 | 1 | 1 |
| 103 | CURR OPS - OPS/S3 | 09 | OPERATIONS ASSISTANT | E5 | 19D20 | R4 | | | NC | 1 | 1 | 1 | 1 |
| 103 | CURR OPS - OPS/S3 | 10 | SCOUT DRIVER | E4 | 19D10 | R4 | | | | 1 | 1 | 1 | 1 |
| 103 | CURR OPS - OPS/S3 | 11 | STRYKER DRIVER | E4 | 19D10 | R4 | | | | 1 | 1 | 1 | 1 |
| 105 | CURR OPS-FIRE SPT/TACP | 03 | STRYKER COMMANDER | E5 | 19D20 | | | | NC | 1 | 1 | 1 | 1 |
| 105 | CURR OPS-FIRE SPT/TACP | 05 | STRYKER DRIVER | E4 | 19D10 | | | | | 1 | 1 | 1 | 1 |
| 107 | SUSTAINMENT-S4 | 01 | S4 | O3 | 19A00 | | | | AR | 1 | 1 | 1 | 1 |
| 111 | TROOP HEADQUARTERS | 01 | COMMANDER | O3 | 19A00 | | | | AR | 1 | 1 | 1 | 1 |
| 111 | TROOP HEADQUARTERS | 02 | EXECUTIVE OFFICER | O2 | 19A00 | | | | AR | 1 | 1 | 1 | 1 |
| 111 | TROOP HEADQUARTERS | 03 | FIRST SERGEANT | E8 | 19Z5M | | | | NC | 1 | 1 | 1 | 1 |
| 111 | TROOP HEADQUARTERS | 06 | VEHICLE DRIVER | E3 | 19D10 | 1K | | | | 1 | 1 | 1 | 1 |
| 201 | TROOP HEADQUARTERS | 01 | COMMANDER | O3 | 19A00 | R4 | | | AR | 1 | 1 | 3 | 3 |
| 201 | TROOP HEADQUARTERS | 02 | EXECUTIVE OFFICER | O2 | 19A00 | R4 | | | AR | 1 | 1 | 3 | 3 |
| 201 | TROOP HEADQUARTERS | 03 | FIRST SERGEANT | E8 | 19Z5M | | | | NC | 1 | 1 | 3 | 3 |
| 201 | TROOP HEADQUARTERS | 04 | OPERATIONS ASSISTANT | E5 | 19D20 | R4 | | | NC | 1 | 1 | 3 | 3 |
| 201 | TROOP HEADQUARTERS | 08 | OPERATIONS ASSISTANT | E4 | 19D10 | R4 | | | | 1 | 1 | 3 | 3 |
| 201 | TROOP HEADQUARTERS | 09 | STRYKER DRIVER | E4 | 19D10 | R4 | | | | 1 | 1 | 3 | 3 |
| 201 | TROOP HEADQUARTERS | 10 | STRYKER DRIVER | E4 | 19D10 | 1K | R4 | | | 1 | 1 | 3 | 3 |
| 203 | SCOUT PLATOON HEADQUAR | 01 | PLATOON LEADER | O2 | 19A00 | 5R | R4 | | AR | 2 | 2 | 6 | 6 |
| 203 | SCOUT PLATOON HEADQUAR | 02 | PLATOON SERGEANT | E7 | 19D40 | F7 | R4 | | NC | 2 | 2 | 6 | 6 |
| 203 | SCOUT PLATOON HEADQUAR | 03 | TEAM LEADER | E5 | 19D2G | R4 | | | NC | 2 | 2 | 6 | 6 |
| 203 | SCOUT PLATOON HEADQUAR | 04 | TEAM LEADER | E5 | 19D20 | R4 | | | NC | 2 | 2 | 6 | 6 |
| 203 | SCOUT PLATOON HEADQUAR | 05 | SCOUT | E4 | 19D10 | R4 | | | | 2 | 2 | 6 | 6 |
| 203 | SCOUT PLATOON HEADQUAR | 06 | SCOUT | E4 | 19D10 | 2C | R4 | | | 2 | 2 | 6 | 6 |
| 203 | SCOUT PLATOON HEADQUAR | 07 | STRYKER GUNNER | E4 | 19D10 | R4 | | | | 4 | 4 | 12 | 12 |
| 203 | SCOUT PLATOON HEADQUAR | 08 | SCOUT | E3 | 19D10 | R4 | | | | 4 | 4 | 12 | 12 |
| 203 | SCOUT PLATOON HEADQUAR | 09 | STRYKER DRIVER | E3 | 19D10 | R4 | | | | 4 | 4 | 12 | 12 |
| 204 | SCOUT SECTION | 01 | SQUAD LEADER | E6 | 19D3G | F7 | R4 | | NC | 4 | 4 | 12 | 12 |
| 204 | SCOUT SECTION | 02 | SQUAD LEADER | E6 | 19D30 | F7 | R4 | | NC | 4 | 4 | 12 | 12 |
| 204 | SCOUT SECTION | 03 | TEAM LEADER | E5 | 19D2G | R4 | | | NC | 4 | 4 | 12 | 12 |
| 204 | SCOUT SECTION | 04 | TEAM LEADER | E5 | 19D20 | R4 | | | NC | 4 | 4 | 12 | 12 |
| 204 | SCOUT SECTION | 05 | SCOUT | E4 | 19D10 | R4 | | | | 4 | 4 | 12 | 12 |
| 204 | SCOUT SECTION | 06 | SCOUT | E4 | 19D10 | 2C | R4 | | | 4 | 4 | 12 | 12 |
| 204 | SCOUT SECTION | 07 | STRYKER GUNNER | E4 | 19D10 | R4 | | | | 8 | 8 | 24 | 24 |
| 204 | SCOUT SECTION | 08 | SCOUT | E3 | 19D10 | R4 | | | | 8 | 8 | 24 | 24 |
| 204 | SCOUT SECTION | 09 | STRYKER DRIVER | E3 | 19D10 | R4 | | | | 8 | 8 | 24 | 24 |
| 301 | TROOP HEADQUARTERS | 02 | EXECUTIVE OFFICER | O2 | 19A00 | | | | AR | 1 | 1 | 1 | 1 |
| 301 | TROOP HEADQUARTERS | 04 | MASTER GUNNER | E6 | 19D30 | R8 | | | NC | 1 | 1 | 1 | 1 |
| 303 | MOBILE GUN SYS PLATOON | 01 | PLATOON LEADER | O2 | 19A00 | R4 | | | AR | 3 | 3 | 3 | 3 |
| 303 | MOBILE GUN SYS PLATOON | 02 | PLATOON SERGEANT | E7 | 19D40 | R4 | | | NC | 3 | 3 | 3 | 3 |
| 303 | MOBILE GUN SYS PLATOON | 03 | MGS COMMANDER | E6 | 19D30 | R4 | | | NC | 3 | 3 | 3 | 3 |
| 303 | MOBILE GUN SYS PLATOON | 04 | MGS COMMANDER | E6 | 19D30 | R8 | | | NC | 3 | 3 | 3 | 3 |
| 303 | MOBILE GUN SYS PLATOON | 05 | MGS GUNNER | E5 | 19D20 | R4 | | | NC | 12 | 12 | 12 | 12 |
| 303 | MOBILE GUN SYS PLATOON | 06 | MGS DRIVER | E4 | 19D10 | R4 | | | | 12 | 12 | 12 | 12 |
| XXX | MOBILE GUN SYS PLATOON | 06 | MGS DRIVER | E4 | 19D10 | R4 | | | | 12 | 12 | 12 | 12 |

Chapter 4

Infantry Brigade Combat Team



Infantry Brigade Combat Team

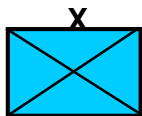

346/42/3820//4208

MCoE SM 3-90
SRC 77202KFC04
9/17/16

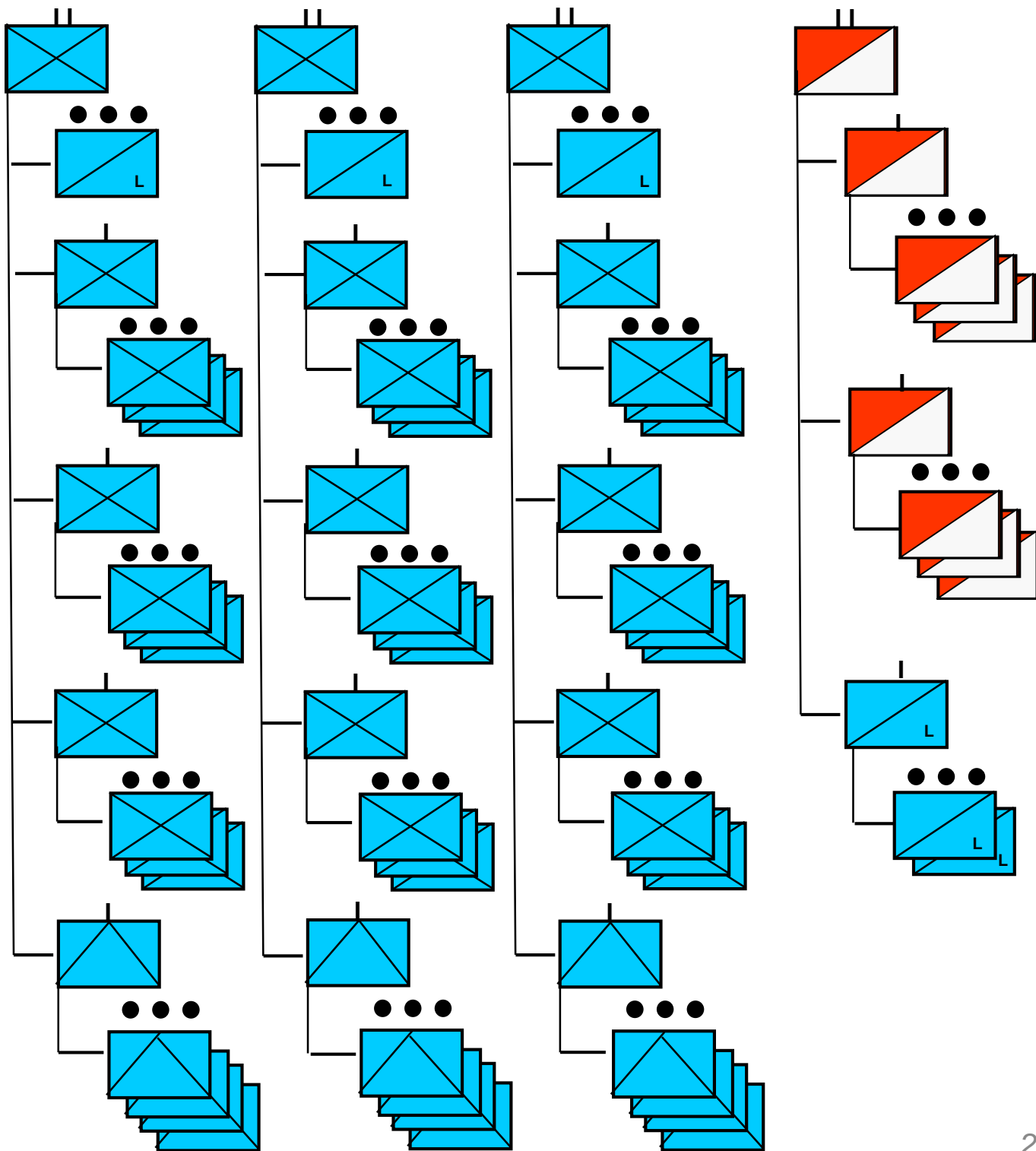









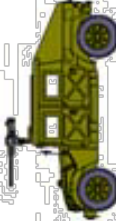

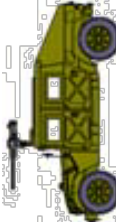
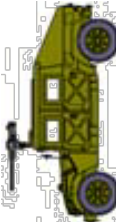

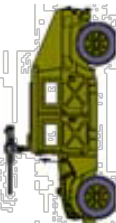















Infantry Brigade Combat Team (IBCT)

30 – Cavalry Troops

90 – Scout Platoons



| | | | | | |
|---|---|---|---|---|---|
|  |  |  |  |  |  |
|  |  |  |  |  |  |
|  |  |  |  |  |  |
|  |  |  |  |  |  |
|  |  |  |  |  |  |

Modified Table of Organization (IBCT)

| IBCT BRIGADE HQs | | | | | | | | | | | | | |
|------------------|----------------------|----|----------------------|-------|-------|------|------|------|-------|--------|---------|---------------|----------------|
| PARNO | PARATITLE | LN | TITLE | GRADE | POSCO | ASI1 | ASI2 | ASI3 | BRNCH | REQSTR | AUTHSTR | PARUNITREQSTR | PARUNITAUTHSTR |
| 102 | CURR OPS | 07 | OPERATIONS ASSISTANT | E4 | 19D1O | | | | | 1 | 1 | 1 | 1 |
| 117 | TAC CUR OPS 1-OPS | 07 | ASST OPERATIONS SGT | E6 | 19D3O | 2S | | | NC | 1 | 1 | 1 | 1 |
| 122 | COMPANY HEADQUARTERS | 03 | FIRST SERGEANT | E8 | 19Z5M | | | | NC | 1 | 1 | 1 | 1 |
| CAVALRY SQUADRON | | | | | | | | | | | | | |
| PARNO | PARATITLE | LN | TITLE | GRADE | POSCO | ASI1 | ASI2 | ASI3 | BRNCH | REQSTR | AUTHSTR | PARUNITREQSTR | PARUNITAUTHSTR |
| 101 | COMMAND GROUP | 05 | SCOUT DRIVER | E4 | 19D1O | | | | | 1 | 1 | 1 | 1 |
| 103 | CURR OPS - OPS/S3 | 02 | PLANS OFFICER | O3 | 19A00 | S7 | | | AR | 3 | 3 | 3 | 3 |
| 103 | CURR OPS - OPS/S3 | 04 | OPERATIONS SERGEANT | E9 | 19Z6O | 6S | | | NC | 1 | 1 | 1 | 1 |
| 103 | CURR OPS - OPS/S3 | 06 | ASST OPERATIONS SGT | E7 | 19D4O | 2S | J3 | | NC | 1 | 1 | 1 | 1 |
| 103 | CURR OPS - OPS/S3 | 07 | ASST OPERATIONS SGT | E6 | 19D3O | 2S | | | NC | 1 | 1 | 1 | 1 |
| 103 | CURR OPS - OPS/S3 | 09 | OPERATIONS ASSISTANT | E5 | 19D2O | | | | NC | 1 | 1 | 1 | 1 |
| 111 | TROOP HEADQUARTERS | 02 | EXECUTIVE OFFICER | O2 | 19A00 | | | | AR | 1 | 1 | 1 | 1 |
| 201 | TROOP HEADQUARTERS | 01 | COMMANDER | O3 | 19A00 | | | | AR | 1 | 1 | 2 | 2 |
| 201 | TROOP HEADQUARTERS | 02 | EXECUTIVE OFFICER | O2 | 19A00 | | | | AR | 1 | 1 | 2 | 2 |
| 201 | TROOP HEADQUARTERS | 03 | FIRST SERGEANT | E8 | 19Z5M | | | | NC | 1 | 1 | 2 | 2 |
| 201 | TROOP HEADQUARTERS | 04 | OPERATIONS NCO | E5 | 19D2O | | | | NC | 1 | 1 | 2 | 2 |
| 201 | TROOP HEADQUARTERS | 08 | OPERATIONS ASSISTANT | E4 | 19D1O | | | | | 1 | 1 | 2 | 2 |
| 201 | TROOP HEADQUARTERS | 09 | SCOUT DRIVER | E4 | 19D1O | 1K | | | | 1 | 1 | 2 | 2 |
| 201 | TROOP HEADQUARTERS | 11 | VEHICLE DRIVER | E3 | 19D1O | | | | | 1 | 1 | 2 | 2 |
| 203 | SCOUT PLATOON | 01 | PLATOON LEADER | O2 | 19A00 | 5R | | | AR | 2 | 2 | 4 | 4 |
| 203 | SCOUT PLATOON | 02 | PLATOON SERGEANT | E7 | 19D4O | | | | NC | 2 | 2 | 4 | 4 |
| 203 | SCOUT PLATOON | 03 | SECTION LEADER | E6 | 19D3O | | | | NC | 4 | 4 | 8 | 8 |
| 203 | SCOUT PLATOON | 04 | TEAM LEADER | E5 | 19D2O | | | | NC | 6 | 6 | 12 | 12 |
| 203 | SCOUT PLATOON | 05 | TOW GUNNER | E5 | 19D2O | | | | NC | 4 | 4 | 8 | 8 |
| 203 | SCOUT PLATOON | 06 | SCOUT | E4 | 19D1O | | | | | 4 | 4 | 8 | 8 |
| 203 | SCOUT PLATOON | 07 | SCOUT JAVELIN GUNNER | E4 | 19D1O | | | | | 2 | 2 | 4 | 4 |
| 203 | SCOUT PLATOON | 08 | SCOUT JAVELIN GUNNER | E4 | 19D1O | 2C | | | | 6 | 6 | 12 | 12 |
| 203 | SCOUT PLATOON | 09 | SCOUT | E3 | 19D1O | | | | | 6 | 6 | 12 | 12 |
| 203 | SCOUT PLATOON | 10 | SCOUT | E3 | 19D1O | | | | | 2 | 2 | 4 | 4 |
| 203 | SCOUT PLATOON | 11 | SCOUT | E3 | 19D1O | | | | | 6 | 6 | 12 | 12 |
| 203 | SCOUT PLATOON | 12 | SCOUT DRIVER | E3 | 19D1O | | | | | 4 | 4 | 8 | 8 |
| 204 | SCOUT PLATOON | 01 | PLATOON LEADER | O2 | 19A00 | 5R | | | AR | 1 | 1 | 2 | 2 |
| 204 | SCOUT PLATOON | 02 | PLATOON SERGEANT | E7 | 19D4O | | | | NC | 1 | 1 | 2 | 2 |
| 204 | SCOUT PLATOON | 03 | SECTION LEADER | E6 | 19D3O | | | | NC | 2 | 2 | 4 | 4 |
| 204 | SCOUT PLATOON | 04 | TEAM LEADER | E5 | 19D2O | | | | NC | 1 | 1 | 2 | 2 |
| 204 | SCOUT PLATOON | 05 | TEAM LEADER | E5 | 19D2O | | | | NC | 2 | 2 | 4 | 4 |
| 204 | SCOUT PLATOON | 06 | TOW GUNNER | E5 | 19D2O | | | | NC | 2 | 2 | 4 | 4 |
| 204 | SCOUT PLATOON | 07 | SCOUT | E4 | 19D1O | | | | | 1 | 1 | 2 | 2 |
| 204 | SCOUT PLATOON | 08 | SCOUT | E4 | 19D1O | | | | | 1 | 1 | 2 | 2 |
| 204 | SCOUT PLATOON | 09 | SCOUT JAVELIN GUNNER | E4 | 19D1O | | | | | 1 | 1 | 2 | 2 |
| 204 | SCOUT PLATOON | 10 | SCOUT JAVELIN GUNNER | E4 | 19D1O | 2C | | | | 3 | 3 | 6 | 6 |
| 204 | SCOUT PLATOON | 11 | SCOUT | E3 | 19D1O | | | | | 2 | 2 | 4 | 4 |
| 204 | SCOUT PLATOON | 12 | SCOUT | E3 | 19D1O | | | | | 1 | 1 | 2 | 2 |
| 204 | SCOUT PLATOON | 13 | SCOUT | E3 | 19D1O | | | | | 1 | 1 | 2 | 2 |
| 204 | SCOUT PLATOON | 14 | SCOUT | E3 | 19D1O | | | | | 3 | 3 | 6 | 6 |
| 204 | SCOUT PLATOON | 15 | SCOUT DRIVER | E3 | 19D1O | | | | | 2 | 2 | 4 | 4 |
| 204 | SCOUT PLATOON | 12 | SCOUT | E3 | 19D1O | | | | | 1 | 1 | 2 | 2 |
| 204 | SCOUT PLATOON | 13 | SCOUT | E3 | 19D1O | | | | | 1 | 1 | 2 | 2 |
| 204 | SCOUT PLATOON | 14 | SCOUT | E3 | 19D1O | | | | | 1 | 1 | 2 | 2 |
| 204 | SCOUT PLATOON | 15 | SCOUT DRIVER | E3 | 19D1O | | | | | 2 | 2 | 4 | 4 |

Modified Table of Organization (IBCT-ABN)

| IBCT (AIRBORNE) BRIGADE HQs | | | | | | | | | | | | | |
|-----------------------------|----------------------|----|----------------------|-------|-------|------|------|------|-------|--------|---------|---------------|----------------|
| PARNO | PARATITLE | LN | TITLE | GRADE | POSCO | ASI1 | ASI2 | ASI3 | BRNCH | REQSTR | AUTHSTR | PARUNITREQSTR | PARUNITAUTHSTR |
| 102 | CURR OPS | 07 | OPERATIONS ASSISTANT | E4 | 19D1P | | | | | 1 | 1 | 1 | 1 |
| 117 | TAC CUR OPS 1-OPS | 07 | ASST OPERATIONS SGT | E6 | 19D3P | 2S | | | NC | 1 | 1 | 1 | 1 |
| 122 | COMPANY HEADQUARTERS | 03 | FIRST SERGEANT | E8 | 19Z5P | | | | NC | 1 | 1 | 1 | 1 |
| CAVALRY SQUADRON (AIRBORNE) | | | | | | | | | | | | | |
| PARNO | PARATITLE | LN | TITLE | GRADE | POSCO | ASI1 | ASI2 | ASI3 | BRNCH | REQSTR | AUTHSTR | PARUNITREQSTR | PARUNITAUTHSTR |
| 101 | COMMAND GROUP | 05 | SCOUT DRIVER | E4 | 19D1P | | | | | 1 | 1 | 1 | 1 |
| 103 | CURR OPS - OPS/S3 | 02 | PLANS OFFICER | O3 | 19A00 | 5P | S7 | | AR | 3 | 3 | 3 | 3 |
| 103 | CURR OPS - OPS/S3 | 04 | OPERATIONS SERGEANT | E9 | 19Z6P | 6S | | | NC | 1 | 1 | 1 | 1 |
| 103 | CURR OPS - OPS/S3 | 06 | ASST OPERATIONS SGT | E7 | 19D4P | 2S | J3 | | NC | 1 | 1 | 1 | 1 |
| 103 | CURR OPS - OPS/S3 | 07 | ASST OPERATIONS SGT | E6 | 19D3P | 2S | | | NC | 1 | 1 | 1 | 1 |
| 103 | CURR OPS - OPS/S3 | 09 | OPERATIONS ASSISTANT | E5 | 19D2P | | | | NC | 1 | 1 | 1 | 1 |
| 111 | TROOP HEADQUARTERS | 02 | EXECUTIVE OFFICER | O2 | 19A00 | 5P | | | AR | 1 | 1 | 1 | 1 |
| 201 | TROOP HEADQUARTERS | 01 | COMMANDER | O3 | 19A00 | 5P | | | AR | 1 | 1 | 2 | 2 |
| 201 | TROOP HEADQUARTERS | 02 | EXECUTIVE OFFICER | O2 | 19A00 | 5P | | | AR | 1 | 1 | 2 | 2 |
| 201 | TROOP HEADQUARTERS | 03 | FIRST SERGEANT | E8 | 19Z5P | | | | NC | 1 | 1 | 2 | 2 |
| 201 | TROOP HEADQUARTERS | 04 | OPERATIONS NCO | E5 | 19D2P | | | | NC | 1 | 1 | 2 | 2 |
| 201 | TROOP HEADQUARTERS | 08 | OPERATIONS ASSISTANT | E4 | 19D1P | | | | | 1 | 1 | 2 | 2 |
| 201 | TROOP HEADQUARTERS | 09 | SCOUT DRIVER | E4 | 19D1P | 1K | | | | 1 | 1 | 2 | 2 |
| 201 | TROOP HEADQUARTERS | 11 | VEHICLE DRIVER | E3 | 19D1P | | | | | 1 | 1 | 2 | 2 |
| 203 | SCOUT PLATOON | 01 | PLATOON LEADER | O2 | 19A00 | 5S | | | AR | 2 | 2 | 4 | 4 |
| 203 | SCOUT PLATOON | 02 | PLATOON SERGEANT | E7 | 19D4P | | | | NC | 2 | 2 | 4 | 4 |
| 203 | SCOUT PLATOON | 03 | SECTION LEADER | E6 | 19D3P | | | | NC | 4 | 4 | 8 | 8 |
| 203 | SCOUT PLATOON | 04 | TEAM LEADER | E5 | 19D2P | | | | NC | 6 | 6 | 12 | 12 |
| 203 | SCOUT PLATOON | 05 | TOW GUNNER | E5 | 19D2P | | | | NC | 4 | 4 | 8 | 8 |
| 203 | SCOUT PLATOON | 06 | SCOUT | E4 | 19D1P | | | | | 4 | 4 | 8 | 8 |
| 203 | SCOUT PLATOON | 07 | SCOUT JAVELIN GUNNER | E4 | 19D1P | | | | | 2 | 2 | 4 | 4 |
| 203 | SCOUT PLATOON | 08 | SCOUT JAVELIN GUNNER | E4 | 19D1P | 2C | | | | 6 | 6 | 12 | 12 |
| 203 | SCOUT PLATOON | 09 | SCOUT | E3 | 19D1P | | | | | 6 | 6 | 12 | 12 |
| 203 | SCOUT PLATOON | 10 | SCOUT | E3 | 19D1P | | | | | 2 | 2 | 4 | 4 |
| 203 | SCOUT PLATOON | 11 | SCOUT | E3 | 19D1P | | | | | 6 | 6 | 12 | 12 |
| 203 | SCOUT PLATOON | 12 | SCOUT DRIVER | E3 | 19D1P | | | | | 4 | 4 | 8 | 8 |
| 204 | SCOUT PLATOON | 01 | PLATOON LEADER | O2 | 19A00 | 5S | | | AR | 1 | 1 | 2 | 2 |
| 204 | SCOUT PLATOON | 02 | PLATOON SERGEANT | E7 | 19D4P | | | | NC | 1 | 1 | 2 | 2 |
| 204 | SCOUT PLATOON | 03 | SECTION LEADER | E6 | 19D3P | | | | NC | 2 | 2 | 4 | 4 |
| 204 | SCOUT PLATOON | 04 | TEAM LEADER | E5 | 19D2P | | | | NC | 1 | 1 | 2 | 2 |
| 204 | SCOUT PLATOON | 05 | TEAM LEADER | E5 | 19D2P | | | | NC | 2 | 2 | 4 | 4 |
| 204 | SCOUT PLATOON | 06 | TOW GUNNER | E5 | 19D2P | | | | NC | 2 | 2 | 4 | 4 |
| 204 | SCOUT PLATOON | 07 | SCOUT | E4 | 19D1P | | | | | 1 | 1 | 2 | 2 |
| 204 | SCOUT PLATOON | 08 | SCOUT | E4 | 19D1P | | | | | 1 | 1 | 2 | 2 |
| 204 | SCOUT PLATOON | 09 | SCOUT JAVELIN GUNNER | E4 | 19D1P | | | | | 1 | 1 | 2 | 2 |
| 204 | SCOUT PLATOON | 10 | SCOUT JAVELIN GUNNER | E4 | 19D1P | 2C | | | | 3 | 3 | 6 | 6 |
| 204 | SCOUT PLATOON | 11 | SCOUT | E3 | 19D1P | | | | | 2 | 2 | 4 | 4 |
| 204 | SCOUT PLATOON | 12 | SCOUT | E3 | 19D1P | | | | | 1 | 1 | 2 | 2 |
| 204 | SCOUT PLATOON | 13 | SCOUT | E3 | 19D1P | | | | | 1 | 1 | 2 | 2 |
| 204 | SCOUT PLATOON | 14 | SCOUT | E3 | 19D1O | | | | | 3 | 3 | 6 | 6 |
| 204 | SCOUT PLATOON | 15 | SCOUT DRIVER | E3 | 19D1P | | | | | 2 | 2 | 4 | 4 |
| 204 | SCOUT PLATOON | 12 | SCOUT | E3 | 19D1O | | | | | 1 | 1 | 2 | 2 |
| 204 | SCOUT PLATOON | 13 | SCOUT | E3 | 19D1O | | | | | 1 | 1 | 2 | 2 |
| 204 | SCOUT PLATOON | 14 | SCOUT | E3 | 19D1O | | | | | 1 | 1 | 2 | 2 |
| 204 | SCOUT PLATOON | 15 | SCOUT DRIVER | E3 | 19D1O | | | | | 2 | 2 | 4 | 4 |

Chapter 5

Personnel and Equipment Quick References

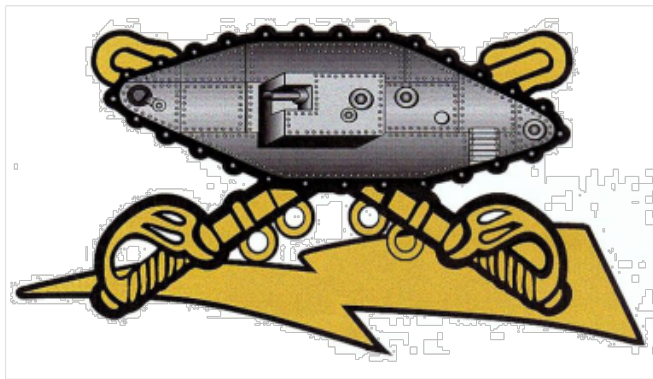

Officer and Enlisted Skill Identifiers

| Skill Qualification Identifiers (SQI) | | |
|---|--|----------|
| SQI | TITLE | PERSTRUC |
| B | INSPECTOR GENERAL NONCOMMISSIONED OFFICER | B |
| E | MILITARY MOUNTAINEER | B |
| G | RANGER | B |
| M | FIRST SERGEANT | B |
| O | NO SPECIAL QUALIFICATIONS | B |
| P | PARACHUTIST | B |
| Q | EQUAL OPPORTUNITY ADVISOR (EOA) | B |
| V | RANGER PARACHUTIST | B |
| X | DRILL SERGEANT | B |
| 2 | TRAINING DEVELOPMENT | B |
| 4 | NON-CAREER RECRUITER | B |
| 8 | INSTRUCTOR | B |
| Skill Identifiers (SI) / Additional Skill Identifiers (ASI) | | |
| SI / ASI | TITLE | PERSTRUC |
| A8 | MASTER GUNNERY M1/M1A1 TANK | B |
| B4 | SNIPER | B |
| B8 | HEAVY WEAPONS LEADER COURSE | P |
| B9 | BRADLEY M2A3/M3A3 OPERATOR/SYSTEM MAINTAINER | B |
| D3 | BRADLEY FIGHTING VEHICLE OPERATIONS AND MAINTENANCE | B |
| C6 | CAVALRY LEADER | B |
| F7 | PATHFINDER | B |
| J3 | BRADLEY INF FIGHTING VEHICLE (BIFV) SYS MASTER GUNNER | B |
| K4 | M1A2 TANK OPERATIONS AND MAINTENANCE | B |
| K8 | MASTER GUNNERY M1A2 TANK | B |
| M9 | MASTER DRIVER TRAINER | P |
| P5 | MASTER FITNESS TRAINER | P |
| R4 | STRYKER ARMORED VEHICLE OPERATIONS/MAINTENANCE | B |
| R7 | ARMY RECONNAISSANCE | P |
| R8 | MOBILE GUN SYSTEM MASTER GUNNER | B |
| S4 | SAPPER LEADER | B |
| S7 | | B |
| S8 | SUAS MASTER TRAINER (PENDING APPROVAL) | B |
| U9 | ASYMMETRIC WARFARE OPERATIONAL SPECIALIST | B |
| 1K | CREW MASTER GUNNER | B |
| 2B | AIR ASSAULT | P |
| 2C | JAVELIN GUNNERY | B |
| 2S | BATTLE STAFF OPERATIONS | B |
| 3H | JOINT PLANNER | B |
| 3J | M1A2 ABRAMS TANK (OFFICER) | B |
| 3S | UNIT AIR MOVEMENTS OFFICER (OFFICER) | B |
| 3X | BRADLEY LEADERS (OFFICER) | B |
| 3Z | MORTAR UNIT OFFICER (OFFICER) | B |
| 4S | USAREC STATION COMMANDER (PENDING APPROVAL) | B |
| 5A | JOINT AIR TACTICAL OPERATIONS | B |
| 5C | MISSION COMMAND DIGITAL MASTER GUNNER (MCDMG) | P |
| 5K | INSTRUCTOR (OFFICER) | B |
| 5P | PARACHUTIST (OFFICER) | B |
| 5Q | PATHFINDER (OFFICER) | B |
| 5R | RANGER (OFFICER) | B |
| 5S | RANGER-PARACHUTIST (OFFICER) | B |
| 5U | AIR OPERATIONS OFFICER (OFFICER) | B |
| 5U | TACTICAL AIR OPERATIONS (ENLISTED) | B |
| 5W | JUMPMASTER | P |
| 6B | RECONNAISSANCE AND SURVEILLANCE LEADERS COURSE | P |
| 6C | BATTALION LEVEL CSM EXPERIENCE | B |
| 6P | MASTER FITNESS TRAINER (OFFICER) | B |
| 6S | INITIAL LEVEL SERGEANT MAJOR (SGM) EXPERIENCE (ENLISTED) | B |
| 7C | BRIGADE LEVEL COMMAND SERGEANT MAJOR (CSM) EXPERIENCE | B |
| 7S | PRIMARY LEVEL SERGEANT MAJOR (SGM) EXPERIENCE | B |
| 8C | GENERAL OFFICER LEVEL 1 CSM EXPERIENCE | B |
| 8D | GENERAL OFFICER LEVEL 2 CSM EXPERIENCE | B |
| 8E | GENERAL OFFICER LEVEL 3 CSM EXPERIENCE | B |
| 8F | GENERAL OFFICER LEVEL 4 CSM EXPERIENCE | B |
| 8R | MASTER RESILIENCE TRAINER (MRT) | P |
| 8S | SENIOR LEVEL 1 SERGEANT MAJOR (SGM) EXPERIENCE | B |
| 8T | SENIOR LEVEL 2 SERGEANT MAJOR (SGM) EXPERIENCE | B |
| 8U | SENIOR LEVEL 3 SERGEANT MAJOR (SGM) EXPERIENCE | B |
| 8V | SENIOR LEVEL 4 SERGEANT MAJOR (SGM) EXPERIENCE | B |









B = Position & Personnel / P = Personnel Only

Skill Identifier Positions

| DIV | Unit | A8 | | | K8 | | | J3 | | | R8 | | | RANGER | | | PATHFINDER | | |
|---|----------|-----|-----|-----|-----|-----|-----|-----|-----|-----|-----|-----|-----|--------|-----|----|------------|-----|----|
| | | SSG | SFC | MSG | SSG | SFC | MSG | SSG | SFC | MSG | SSG | SFC | MSG | SGT | SSG | LT | SSG | SFC | LT |
|  | 1st SBCT | | | | | | | | | | | | | | | | | | |
| | 3-41 IN | | | | | | | | | | | | | 3 | 2 | | 2 | 1 | |
| | 1-36 IN | | | | | | | | | | | | | 3 | 2 | | 2 | 1 | |
| | 4-17 IN | | | | | | | | | | | | | 3 | 2 | | 2 | 1 | |
| | 6-1 CAV | | | | | | | | | | | 4 | | | 18 | 12 | 6 | 24 | 6 |
| | 2nd ABCT | | | | | | | | | | | | | | | | | | |
| | 1-6 IN | | | | | 1 | 1 | | | 1 | | | | | | | 3 | 1 | |
| | 1-35 AR | | | | | 2 | 1 | | | 1 | | | | | | | 3 | 1 | |
| | 1-37 AR | | | | | 2 | 1 | | | 1 | | | | | | | 3 | 1 | |
| | 1-1 CAV | | | | | 1 | 1 | | | 3 | 1 | | | | 12 | 12 | 6 | 12 | 6 |
| | 3rd ABCT | | | | | | | | | | | | | | | | | | |
| | 4-6 IN | | | | | 1 | 1 | | | 1 | | | | | | | 3 | 1 | |
| | 1-67 AR | | | | | 2 | 1 | | | 1 | | | | | | | 3 | 1 | |
| 1-77 AR | | | | | 2 | 1 | | | 1 | | | | | | | 3 | 1 | | |
| 2-13 CAV | | | | | 1 | 1 | | | 3 | 1 | | | | | | | | | |
| 1st ABCT | | | | | | | | | | | | | | | | | | | |
| 2-5 CAV | | | | | 1 | 1 | | | 1 | | | | | | | 3 | 1 | | |
| 2-8 CAV | | | | | 2 | 1 | | | 1 | | | | | | | 3 | 1 | | |
| 2-12 CAV | | | | | 2 | 1 | | | 1 | | | | | | | 3 | 1 | | |
| 1-7 CAV (RECON) | | | | | 1 | 1 | | | 3 | 1 | | | | 12 | 12 | 6 | 12 | 6 | |
| 2nd ABCT | | | | | | | | | | | | | | | | | | | |
| 1-5 CAV | | | | | 1 | 1 | | | 1 | | | | | | | 3 | 1 | | |
| 1-8 CAV | | | | | 2 | 1 | | | 1 | | | | | | | 3 | 1 | | |
| 1-9 CAV | | | | | 2 | 1 | | | 1 | | | | | | | 3 | 1 | | |
| 4-9 CAV (RECON) | | | | | 1 | 1 | | | 3 | 1 | | | | 12 | 12 | 6 | 12 | 6 | |
| 3rd ABCT | | | | | | | | | | | | | | | | | | | |
| 2-7 CAV | | | | | 1 | 1 | | | 1 | | | | | | | 3 | 1 | | |
| 3-8 CAV | | | | | 2 | 1 | | | 1 | | | | | | | 3 | 1 | | |
| 1-12 CAV | | | | | 2 | 1 | | | 1 | | | | | | | 3 | 1 | | |
| 6-9 CAV (RECON) | | | | | 1 | 1 | | | 3 | 1 | | | | 12 | 12 | 6 | 12 | 6 | |
| 1st ABCT | | | | | | | | | | | | | | | | | | | |
| 1-16 IN | | | | | 1 | 1 | | | 1 | | | | | | | 3 | 1 | | |
| 2-34 AR | | | | | 2 | 1 | | | 1 | | | | | | | 3 | 1 | | |
| 3-66 AR | | | | | 2 | 1 | | | 1 | | | | | | | 3 | 1 | | |
| 1-4 CAV | | | | | 1 | 1 | | | 3 | 1 | | | | 12 | 12 | 6 | 12 | 6 | |
| 2nd ABCT | | | | | | | | | | | | | | | | | | | |
| 1-18 IN | | | | | 1 | 1 | | | 1 | | | | | | | 3 | 1 | | |
| 1-63 AR | | | | | 2 | 1 | | | 1 | | | | | | | 3 | 1 | | |
| 2-70 AR | | | | | 2 | 1 | | | 1 | | | | | | | 3 | 1 | | |
| 5-4 CAV | | | | | 1 | 1 | | | 3 | 1 | | | | 12 | 12 | 6 | 12 | 6 | |
| 1st SBCT | | | | | | | | | | | | | | | | | | | |
| 5-20 IN | | | | | | | | | | | | | | 3 | 2 | | 2 | 1 | |
| 1-23 IN | | | | | | | | | | | | | | 3 | 2 | | 2 | 1 | |
| 2-3 IN | | | | | | | | | | | | | | 3 | 2 | | 2 | 1 | |
| 1-14 CAV | | | | | | | | | | | 4 | | | 18 | 12 | 6 | 24 | 6 | |
| 2nd SBCT | | | | | | | | | | | | | | | | | | | |
| 2-1 IN | | | | | | | | | | | | | | 3 | 2 | | 2 | 1 | |
| 1-17 IN | | | | | | | | | | | | | | 3 | 2 | | 2 | 1 | |
| 4-23 IN | | | | | | | | | | | | | | 3 | 2 | | 2 | 1 | |
| 8-1 CAV | | | | | | | | | | | 4 | | | 18 | 12 | 6 | 24 | 6 | |
| 1st ABCT | | | | | | | | | | | | | | | | | | | |
| 2-7 IN | | | | | 1 | 1 | | | 1 | | | | | | | 3 | 1 | | |
| 3-69 AR | | | | | 2 | 1 | | | 1 | | | | | | | 3 | 1 | | |
| 1-64 AR | | | | | 2 | 1 | | | 1 | | | | | | | 3 | 1 | | |
| 5-7 CAV | | | | | 1 | 1 | | | 3 | 1 | | | | 12 | 12 | 6 | 12 | 6 | |
| 2nd IBCT | | | | | | | | | | | | | | | | | | | |
| 3-7 IN | | | | | | | | | | | | | | | | | | | |
| 3-15 IN | | | | | | | | | | | | | | | | | | | |
| 1-30 IN | | | | | | | | | | | | | | | | | | | |
| 6-8 CAV | | | | | | | | | | 1 | | | | | | 6 | | | |
| 1st SBCT | | | | | | | | | | | | | | | | | | | |
| 4-9 IN | | | | | | | | | | | | | | 3 | 2 | | 2 | 1 | |
| 2-23 IN | | | | | | | | | | | | | | 3 | 2 | | 2 | 1 | |
| 1-38 IN | | | | | | | | | | | | | | 3 | 2 | | 2 | 1 | |
| 2-1 CAV | | | | | | | | | | | 4 | | | 18 | 12 | 6 | 24 | 6 | |
| 2nd IBCT | | | | | | | | | | | | | | | | | | | |
| 1-12 IN | | | | | | | | | | | | | | | | | | | |
| 2-12 IN | | | | | | | | | | | | | | | | | | | |
| 1-41 IN | | | | | | | | | | | | | | | | | | | |
| 3-61 CAV | | | | | | | | | | 1 | | | | | | 6 | | | |
| 3rd ABCT | | | | | | | | | | | | | | | | | | | |
| 1-8 IN | | | | | 1 | 1 | | | 1 | | | | | | | 3 | 1 | | |
| 1-68 AR | | | | | 2 | 1 | | | 1 | | | | | | | 3 | 1 | | |
| 1-66 AR | | | | | 2 | 1 | | | 1 | | | | | | | 3 | 1 | | |
| 4-10 CAV | | | | | 1 | 1 | | | 3 | 1 | | | | 12 | 12 | 6 | 12 | 6 | |
| 1st IBCT | | | | | | | | | | | | | | | | | | | |
| 1-87 IN | | | | | | | | | | | | | | | | | | | |
| 2-22 IN | | | | | | | | | | | | | | | | | | | |
| 1-32 IN | | | | | | | | | | | | | | | | | | | |
| 1-71 CAV | | | | | | | | | 1 | | | | | | | 6 | | | |
| 2nd IBCT | | | | | | | | | | | | | | | | | | | |
| 2-14 IN | | | | | | | | | | | | | | | | | | | |
| 4-31 IN | | | | | | | | | | | | | | | | | | | |
| 2-87 IN | | | | | | | | | | | | | | | | | | | |
| 1-89 CAV | | | | | | | | | 1 | | | | | | | 6 | | | |
| 3rd IBCT | | | | | | | | | | | | | | | | | | | |
| 2-2 IN | | | | | | | | | | | | | | | | | | | |
| 2-4 IN | | | | | | | | | | | | | | | | | | | |
| 2-30 IN | | | | | | | | | | | | | | | | | | | |
| 3-89 CAV | | | | | | | | | 1 | | | | | | | 6 | | | |

Skill Identifier Positions cont..

MTOE/TDA RMSWEB FY17

| DIV | Unit | A8 | | | K8 | | | J3 | | | R8 | | | RANGER | | | PATHFINDER | | |
|---|----------------|----------|----------|----------|-----------|-----------|-----------|-----------|-----------|----------|-----------|----------|----------|------------|------------|------------|------------|------------|----------|
| | | SSG | SFC | MSG | SSG | SFC | MSG | SSG | SFC | MSG | SSG | SFC | MSG | SGT | SSG | LT | SSG | SFC | LT |
|  | 1st SBCT | | | | | | | | | | | | | | | | | | |
| | 1-5 IN | | | | | | | | | | | | | 3 | 2 | | 2 | 1 | |
| | 1-24 IN | | | | | | | | | | | | | 3 | 2 | | 2 | 1 | |
| | 3-21 IN | | | | | | | | | | | | | 3 | 2 | | 2 | 1 | |
| | 5-1 CAV | | | | | | | | | | | 4 | | 18 | 12 | 6 | 24 | 6 | |
| | 2nd IBCT | | | | | | | | | | | | | | | | | | |
| | 1-14 IN | | | | | | | | | | | | | | | | | | |
| | 1-21 IN | | | | | | | | | | | | | | | | | | |
| | 1-27 IN | | | | | | | | | | | | | | | | | | |
| | 2-14 CAV | | | | | | | | | 1 | | | | | | | 6 | | |
| | 3rd IBCT | | | | | | | | | | | | | | | | | | |
| | 2-27 IN | | | | | | | | | | | | | | | | | | |
| | 2-35 IN | | | | | | | | | | | | | | | | | | |
| | 3-4 CAV | | | | | | | | | 1 | | | | | | | 6 | | |
| | 4th IBCT (ABN) | | | | | | | | | | | | | | | | | | |
| 1-501 PIR | | | | | | | | | | | | | | | | | | | |
| 3-509 PIR | | | | | | | | | | | | | | | | | | | |
| 1-40 CAV | | | | | | | | | 1 | | | | | | | 6 | | | |
|  | 1st IBCT (ABN) | | | | | | | | | | | | | | | | | | |
| | 1-504 PIR | | | | | | | | | | | | | | | | | | |
| | 2-504 PIR | | | | | | | | | | | | | | | | | | |
| | 2-501 PIR | | | | | | | | | | | | | | | | | | |
| | 3-73 CAV | | | | | | | | | 1 | | | | | | 6 | | | |
| | 2nd IBCT (ABN) | | | | | | | | | | | | | | | | | | |
| | 1-325 PIR | | | | | | | | | | | | | | | | | | |
| | 2-325 PIR | | | | | | | | | | | | | | | | | | |
| | 2-508 PIR | | | | | | | | | | | | | | | | | | |
| | 1-73 CAV | | | | | | | | | 1 | | | | | | | 6 | | |
| | 3rd IBCT (ABN) | | | | | | | | | | | | | | | | | | |
| | 1-505 PIR | | | | | | | | | | | | | | | | | | |
| | 2-505 PIR | | | | | | | | | | | | | | | | | | |
| | 1-508 PIR | | | | | | | | | | | | | | | | | | |
| | 5-73 CAV | | | | | | | | | 1 | | | | | | | 6 | | |
|  | 1st IBCT | | | | | | | | | | | | | | | | | | |
| | 1-327 IN | | | | | | | | | | | | | | | | | | |
| | 2-327 IN | | | | | | | | | | | | | | | | | | |
| | 1-506 IN | | | | | | | | | | | | | | | | | | |
| | 1-32 CAV | | | | | | | | | 1 | | | | | | 6 | | | |
| | 2nd IBCT | | | | | | | | | | | | | | | | | | |
| | 1-502 IN | | | | | | | | | | | | | | | | | | |
| | 2-502 IN | | | | | | | | | | | | | | | | | | |
| | 1-26 IN | | | | | | | | | | | | | | | | | | |
| | 1-75 CAV | | | | | | | | | 1 | | | | | | | 6 | | |
| | 3rd IBCT | | | | | | | | | | | | | | | | | | |
| | 2-506 IN | | | | | | | | | | | | | | | | | | |
| | 1-187 IN | | | | | | | | | | | | | | | | | | |
| | 3-187 IN | | | | | | | | | | | | | | | | | | |
| | 1-33 CAV | | | | | | | | | 1 | | | | | | | 6 | | |
| 173rd (ABN) | | | | | | | | | | | | | | | | | | | |
| 1-503 IN | | | | | | | | | | | | | | | | | | | |
| 2-503 IN | | | | | | | | | | | | | | | | | | | |
| 1-91 CAV | | | | | | | | | | 1 | | | | | | 6 | | | |
|  | 2nd CR | | | | | | | | | | | | | | | | | | |
| | 1-2 CAV | | | | | | | | | | | | | 3 | 2 | | 2 | 1 | |
| | 2-2 CAV | | | | | | | | | | | | | 3 | 2 | | 2 | 1 | |
| | 3-2 CAV | | | | | | | | | | | | | 3 | 2 | | 2 | 1 | |
| | 4-2 CAV | | | | | | | | | | | 4 | | 18 | 12 | 6 | 24 | 6 | |
|  | 3rd CR | | | | | | | | | | | | | | | | | | |
| | 1-3 CAV | | | | | | | | | | | | | 3 | 2 | | 2 | 1 | |
| | 2-3 CAV | | | | | | | | | | | | | 3 | 2 | | 2 | 1 | |
| | 3-3 CAV | | | | | | | | | | | | | 3 | 2 | | 2 | 1 | |
| | 4-3 CAV | | | | | | | | | | | 4 | | 18 | 12 | 6 | 24 | 6 | |
|  | 11TH ACR | | | 1 | | | | | | | | | | | | | | | |
| | 1-11 AR CAV | 2 | | 1 | | | | | | | | | | | | | | | |
| | 2-11 AR CAV | 2 | | | | | | | | | | | | | | | | 2 | |
| Fort Benning | | | | | | | | | | | | | | | | | | | |
|  | 194th AR BDE | | | | | | | | | | | | | | | | | | |
| | 5-15 CAV | | | | | | | | 1 | | | | | | | | | | |
| | 1-81 AR | | | | | | | | | | | | | | | | | | |
| 3-81 AR | | | | | | | | | | | | | | | | | | | |
|  | 316th CAV BDE | | | | | 1 | | | 1 | | | | | | | | | | |
| | 1-29 IN | | | | | | | | | 1 | | | | 2 | 1 (SFC) | 1 | | | |
| | 1-16 CAV | | | | | 6 | 1 | | 1 | 1 | | | | | | | | | |
| | 3-16 CAV | | | | | 7 | 15 | 1 | 1 | | | | | | | | | 1 | |
| TOTALS: | | 4 | 2 | 0 | 68 | 52 | 10 | 31 | 52 | 1 | 28 | 0 | 0 | 297 | 236 | 187 | 190 | 144 | 0 |

Armor Personnel (by AC Brigade)

| | | 19D10 | 19D20 | 19D30 | 19D40 | 19K10 | 19K20 | 19K30 | 19K40 | 19Z50 | 19Z60 | 19A O2 | 19A O3 |
|--------------------------------------|------------------|-------------|-------------|------------|------------|-------------|------------|------------|------------|------------|-----------|------------|------------|
| Armor Brigade Combat Team (9) | BCT HQ | | | | 1 | | | | 1 | 2 | 1 | 1 | |
| | CAB (IN) | 24 | 4 | 6 | 1 | 32 | 15 | 7 | 4 | 1 | | 4 | 1 |
| | CAB (AR) | 24 | 4 | 6 | 1 | 62 | 29 | 14 | 7 | 2 | | 8 | 2 |
| | CAB (AR) | 24 | 4 | 6 | 1 | 62 | 29 | 14 | 7 | 2 | | 8 | 2 |
| | CAV | 157 | 40 | 29 | 8 | 30 | 14 | 7 | 4 | 5 | 2 | 14 | 10 |
| | Total | 229 | 52 | 47 | 12 | 186 | 87 | 42 | 23 | 12 | 3 | 35 | 15 |
| | Total x9 | 2061 | 468 | 423 | 108 | 1674 | 783 | 378 | 207 | 108 | 27 | 315 | 135 |
| | % of Force | 39% | 32% | 45% | 33% | 100% | 100% | 100% | 100% | 60% | 48% | 57% | 52% |
| Stryker Brigade Combat Team (7) | | 19D10 | 19D20 | 19D30 | 19D40 | | | | | 19Z50 | 19Z60 | 19A O2 | 19A O3 |
| | BCT HQ | | | | 2 | | | | | | | | |
| | SIB | 24 | 6 | 4 | 1 | | | | | | | | |
| | SIB | 24 | 6 | 4 | 1 | | | | | | | | |
| | SIB | 24 | 6 | 4 | 1 | | | | | | | | |
| | CAV | 171 | 54 | 31 | 12 | | | | | 4 | 2 | 14 | 7 |
| | Total | 243 | 72 | 43 | 17 | | | | | 4 | 2 | 14 | 7 |
| | Total x7 | 1701 | 504 | 301 | 119 | | | | | 28 | 14 | 98 | 49 |
| % of Force | 33% | 34% | 32% | 35% | | | | | 15% | 25% | 18% | 19% | |
| Infantry Brigade Combat Team (15) | | 19D10 | 19D20 | 19D30 | 19D40 | | | | | 19Z50 | 19Z60 | 19A O2 | 19A O3 |
| | BCT HQ | | | 1 | | | | | | 1 | | | |
| | IN | | | | | | | | | | | | |
| | IN | | | | | | | | | | | | |
| | IN | | | | | | | | | | | | |
| | CAV | 98 | 33 | 13 | 7 | | | | | 2 | 1 | 9 | 5 |
| | Total | 98 | 33 | 14 | 7 | | | | | 3 | 1 | 9 | 5 |
| | Total x15 | 1470 | 495 | 210 | 105 | | | | | 45 | 15 | 135 | 75 |
| % of Force | 28% | 34% | 22% | 32% | | | | | 25% | 27% | 25% | 29% | |
| Brigade Combat Teams (31) | Totals | 5232 | 1467 | 934 | 332 | 1674 | 783 | 378 | 207 | 181 | 56 | 548 | 259 |

Armor Equipment (by AC Brigade) ***

| | | C11158 M973 CARRIER | C18234 M113A3 CARRIER | F60564 M2A3 BFV | J22626 M1126 ICV | M57720 M1128 MGS | R62673 M1127 RV | T07679 M1097 HMMWV | T13305 M1A2 TANK | T34704 M1151A1 HMMWV | T34704 M1151A1 HMMWV | T34840 M1167 HMMWV | T41995 M1081 LMTV | T59448 M1078 LMTV | T61908 M1083 MTV |
|--------------------------------------|------------------|---------------------|-----------------------|-----------------|------------------|------------------|-----------------|--------------------|------------------|----------------------|----------------------|--------------------|-------------------|-------------------|------------------|
| Armor Brigade Combat Team (9) | BCT HQ | 1 | 1 | 1 | | | | 7 | | | | | | 1 | |
| | CAB (IN) | 2 | 1 | 3 | | | | 2 | 15 | 5 | | | | 2 | |
| | CAB (AR) | 2 | 2 | 3 | | | | 3 | 29 | 5 | | | | 4 | |
| | CAB (AR) | 2 | 2 | 3 | | | | 3 | 29 | 5 | | | | 4 | |
| | CAV | 4 | 4 | 41 | | | | 6 | 14 | 1 | | | | 5 | |
| | Total | 11 | 10 | 51 | | | | 21 | 87 | 16 | | | | 16 | |
| | Total x9 | 99 | 90 | 459 | | | | 189 | 783 | 144 | | | | 144 | |
| | % of Force | 100% | 100% | 100% | | | | 84% | 100% | 25% | | | | 100% | |
| Stryker Brigade Combat Team (7) | | | | C41314 M1130 CV | J22626 M1126 ICV | M57720 M1128 MGS | R62673 M1127 RV | T07679 M1097 HMMWV | | | | | | | T61908 M1083 MTV |
| | BCT HQ | | | | | | | | | | | | | | |
| | SIB | | | | | | | 6 | | | | | | | |
| | SIB | | | | | | | 6 | | | | | | | |
| | SIB | | | | | | | 6 | | | | | | | |
| | CAV | | | 5 | 1 | 12 | 39 | 5 | | | | | | | 6 |
| | Total | | | 5 | 1 | 12 | 51 | 5 | | | | | | | 6 |
| | Total x7 | | | 35 | 7 | 84 | 357 | 35 | | | | | | | 90 |
| % of Force | | | 100% | 100% | 100% | 100% | 16% | | | | | | | 100% | |
| Infantry Brigade Combat Team (15) | | | | | | | | | | T34704 M1151A1 HMMWV | T34840 M1167 HMMWV | T41995 M1081 LMTV | | | |
| | BCT HQ | | | | | | | | | | | | | | |
| | IN | | | | | | | | | | | | | | |
| | IN | | | | | | | | | | | | | | |
| | IN | | | | | | | | | | | | | | |
| | CAV | | | | | | | | | 28 | 12 | 3 | | | |
| | Total | | | | | | | | | 28 | 12 | 3 | | | |
| | Total x15 | | | | | | | | | 420 | 180 | 45 | | | |
| % of Force | | | | | | | | | 75% | 100% | 100% | | | | |
| Brigade Combat Teams (31) | Totals | 99 | 90 | 35 | 459 | 7 | 84 | 357 | 224 | 783 | 564 | 180 | 45 | 144 | 90 |

***Equipment totals include Battalion / Squadron Command Groups, S-3 Current Operations, and Company / Troop Headquarters.

Platoon Count

ABCT (9 Total)

| ABCT Tank Plt | | BDE | | Total | Combined Total |
|---------------|----------|-----|-------|-------|-------------------|
| CO | SQDN | 3 | 3 | 27 | |
| 3 | 3 | | | | |
| | CAB(2/1) | BDE | Total | | |
| | 6/3 | 15 | 135 | | 162 |

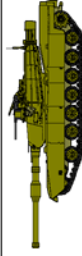

ABCT Tank Plt

ABCT Scout Plt

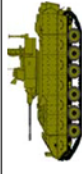

| TRP | SQDN | BDE | Total | Combined Total |
|-----|------|-----|-------|-------------------|
| 2 | 6 | 6 | 54 | |
| | CAB | BDE | Total | |
| | 1 | 3 | 27 | 81 |

SBCT (7 Total)

| SBCT MGS Plt | | BDE | | Total |
|--------------|------|-----|-------|-------|
| TRP | SQDN | BDE | Total | |
| 3 | 3 | 3 | 21 | |

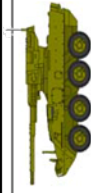

SBCT MGS Plt

SBCT Scout Plt

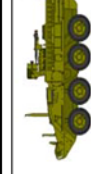

| TRP | SQDN | BDE | Total | Combined Total |
|-----|------|-----|-------|-------------------|
| 2 | 6 | 6 | 42 | |
| | SIB | BDE | Total | |
| | 1 | 3 | 21 | 63 |

IBCT (15 Total)

| IBCT Scout Plt | | BDE | | Total |
|----------------|------|-----|-------|-------|
| TRP | SQDN | BDE | Total | |
| 3* | 6 | 6 | 90 | |



IBCT Scout Plt

*IBCT Cavalry Squadron has a 3rd Troop (dismounted) composed of MOS 11B.

417 TOTAL PLATOONS: 162 AR PLT (39%), 21 MGS PLT (5%), & 234 CAV PLT (56%)