

VEHICLE MG RING CONFIGURATIONS:

As of 22 Sept, 10

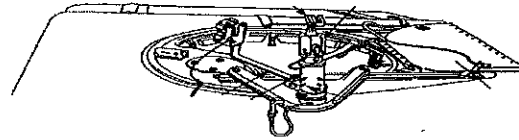

M1025/M1026/M1114 HMMWV PINTLE ADAPTOR

NSN 3120-01-188-5082

OR



M66 MACHINE GUN MOUNT RING

NSN 1005-00-701-2810

(Class II)

The M-66 Ring Mount will bolt directly to the roof of the FMTV LTAS cab. This ring will allow weapon mounting only. Mounting of an OGPK is never possible when using an M-66 Ring. To mount an OGPK on the FMTV LTAS cab, the Weapon Station Kit is needed, (PN 57K6026; NSN 2510-01-567-8727).

The HEMTT A4 variants do not accept the M-66 Ring Mount. Units must order PN# 12505891, NSN 2510-01-578-4322, Turret, Ring Assembly to provide weapon stations to the HEMTT A4 fleet.

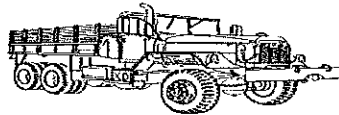

800 SERIES 5-TON & M35 2.5-TON MOUNTING KIT

NSN 1005-01-226-4589

CAB REINFORCEMENT KIT

NSN 2590-01-322-2694

(Class IX)



LMTV & FMTV MOUNTING KIT

NSN 1005-01-381-5431

(Class IX)

OR



LIGHT WEIGHT RING MOUNT



900 SERIES 5-TON LIGHTWEIGHT RING MOUNT

NSN 1005-01-432-3339

(Class IX)

CAB REINFORCEMENT KIT

NSN 2590-01-436-9144

(Class IX)

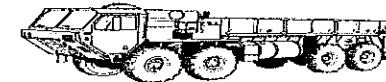

HEMTT MOUNTING KIT

NSN 1005-01-519-2126

Class IX



PLS MOUNTING KIT

NSN 1005-01-523-6549

Class IX

Only weapons safety certified
For M939 is MK19, M2, M60

Only mounts that can be used
On M939 are MK93 mod 1 and
MK64 mod 9

M240B

TRIPOD:

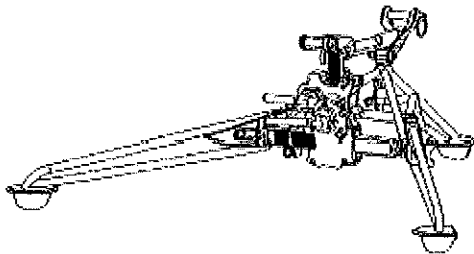
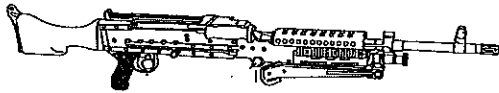

M192 LIGHT WEIGHT GROUND MOUNT
NSN 1005-01-503-0141

OR

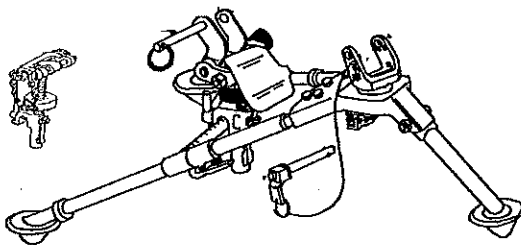

M122A1 MACHINE GUN TRIPOD MOUNT
NSN 1005-01-433-1617

HMMWV PEDESTAL:

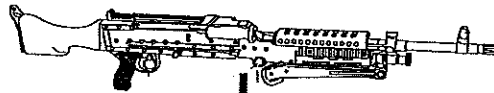

AMMO ADAPTER BRACKET ASSEMBLY
NSN 1005-01-431-8324
DEFLECTOR KIT
NSN 1005-01-468-0552



M197 MACHINE GUN MOUNT
NSN 1005-01-413-4098

UPDATE

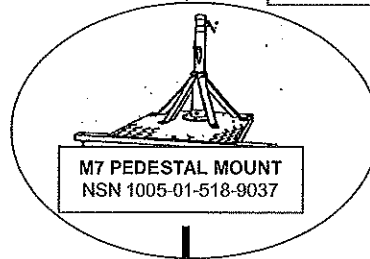

M7 PEDESTAL MOUNT
NSN 1005-01-518-9037

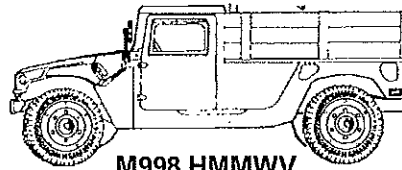

M998 HMMWV

VEHICLE RING MOUNT:

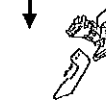
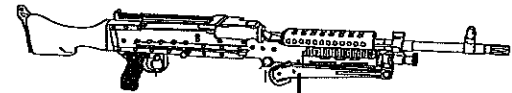

AMMO ADAPTER BRACKET ASSEMBLY
NSN 1005-01-431-8324
DEFLECTOR KIT
NSN 1005-01-468-0552



M197 MACHINE GUN MOUNT
NSN 1005-01-413-4098

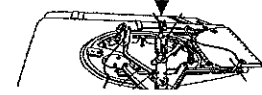

M1025/M1026/M1114 HMMWV PINTLE ADAPTOR
NSN 3120-01-188-5082

OR



MACHINE GUN MOUNT RING
NSN 1005-00-701-2810



800 SERIES 5-TON MOUNTING KIT
NSN 1005-01-226-4589
CAB REINFORCEMENT KIT
NSN 2590-01-322-2694



LMTV & FMTV MOUNTING KIT
NSN 1005-01-381-5431



HEMTT MOUNTING KIT

OR



LIGHT WEIGHT RING MOUNT



900 SERIES 5-TON MOUNTING KIT (RING INCLUDED)
NSN 1005-01-432-3339
CAB REINFORCEMENT KIT
NSN 2590-01-436-9144



HEMTT MOUNTING KIT
NSN 1005-01-519-2126



PLS MOUNTING KIT
NSN 1005-01-523-6549

MK19

TRIPOD:

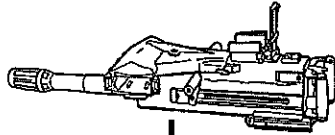

MK93 MOD 1
NSN 1005-01-383-2757

OR

MK64 MOD 9
NSN 1010-01-412-3159

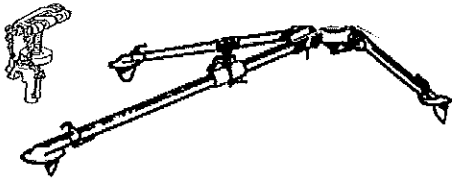
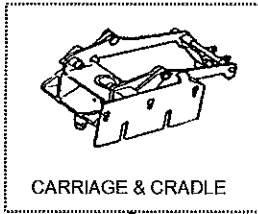
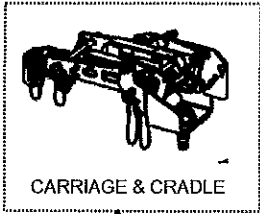

M3 MACHINE GUN TRIPOD MOUNT
NSN 1005-00-322-9716

HMMWV PEDESTAL:

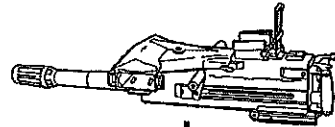

MK93 MOD 1
NSN 1005-01-383-2757

OR

MK64 MOD 9
NSN 1010-01-412-3159

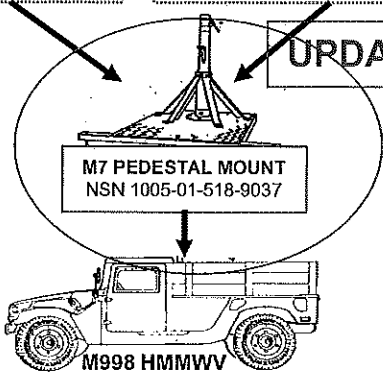
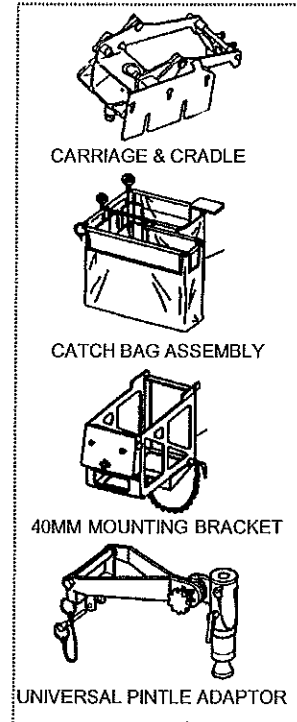
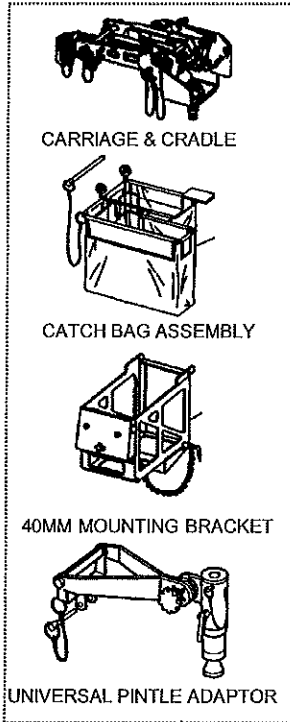

UPDATE

VEHICLE RING MOUNT:

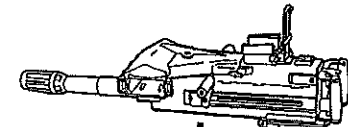

MK93 MOD 1
NSN 1005-01-383-2757

OR

MK64 MOD 9
NSN 1010-01-412-3159

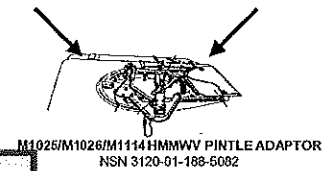
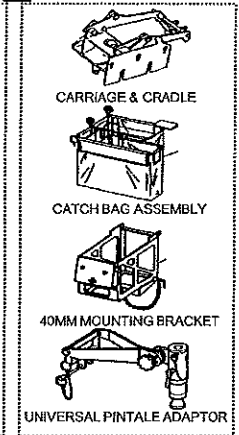
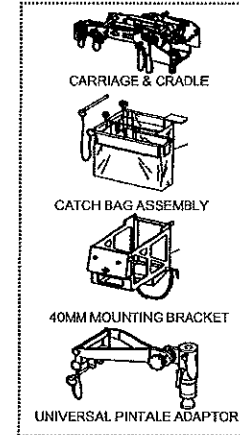

See Notes on
FMTV LTAS
and HEMTT
A4's

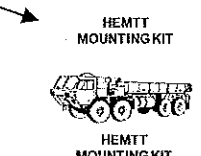

TRIPOD:



MK93 MOD 1
NSN 1005-01-383-2757

OR

MK64 MOD 9
NSN 1010-01-412-3159

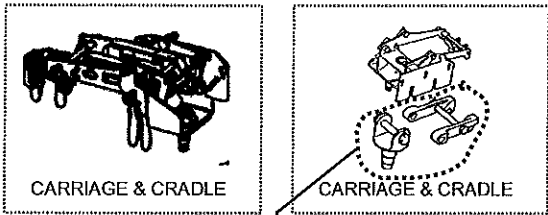

*AAL to MK64 MOD 9
CAL .50 MOUNTING
ADAPTOR ASSY
NSN 1010-01-151-6217

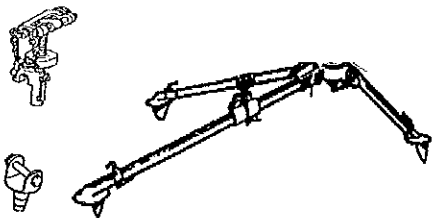

M3 MACHINE GUN TRIPOD MOUNT
NSN 1005-00-322-9716

M2

HMMWV PEDESTAL:



MK93 MOD 1
NSN 1005-01-383-2757

OR

MK64 MOD 9
NSN 1010-01-412-3159

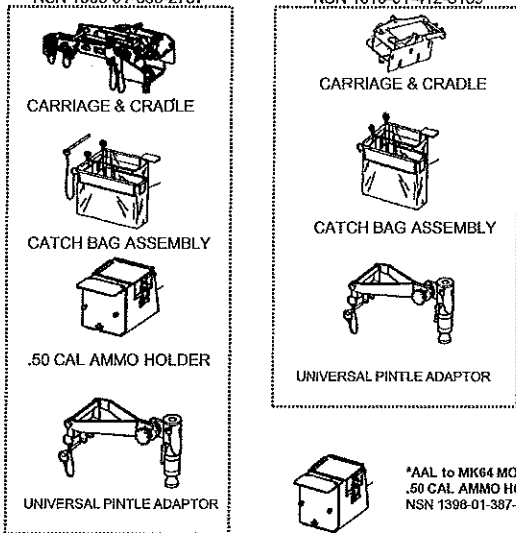

*AAL to MK64 MOD 9
.50 CAL AMMO HOLDER
NSN 1398-01-387-3095

*AAL to MK64 MOD 9
CAL .50 MOUNTING
ADAPTOR ASSY
NSN 1010-01-151-6217

UPDATE

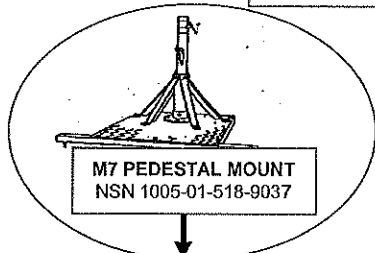

M7 PEDESTAL MOUNT
NSN 1005-01-518-9037

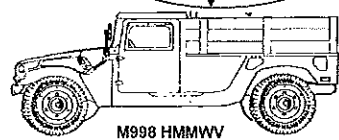

M998 HMMWV

VEHICLE RING MOUNT:



MK93 MOD 1
NSN 1005-01-383-2757

OR

MK64 MOD 9
NSN 1010-01-412-3159

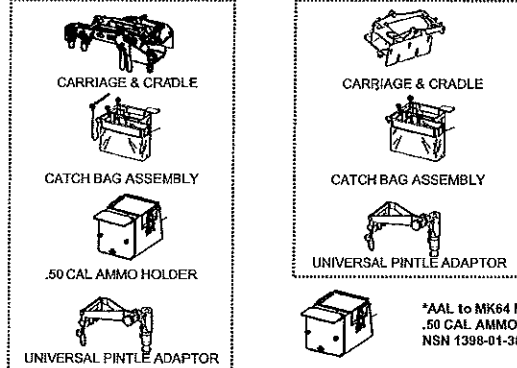

*AAL to MK64 MOD 9
.50 CAL AMMO HOLDER
NSN 1398-01-387-3095

*AAL to MK64 MOD 9
CAL .50 MOUNTING
ADAPTOR ASSY
NSN 1010-01-151-6217

OR



6650 MACHINE GUN MOUNT
NSN 1005-00-704-6650



M1026/M1026/M1114 HMMWV PINTLE ADAPTOR
NSN 3120-01-188-5082

OR

**See Notes on
FMTV LTAS
and HEMTT
A4's**

M66 MACHINE GUN MOUNT RING
NSN 1005-00-701-2810



**800 SERIES 5-TON
MOUNTING KIT
NSN 1005-01-226-4589
CAB REINFORCEMENT KIT
NSN 2590-01-322-2694**



**LMTV & FMTV
MOUNTING KIT
NSN 1005-01-381-6431**

**HEMTT
MOUNTING KIT**



**HEMTT
MOUNTING KIT
NSN 1005-01-519-2126**

LIGHT WEIGHT RING MOUNT



**900 SERIES 5-TON
MOUNTING KIT (RING INCLUDED)
NSN 1005-01-432-3339
CAB REINFORCEMENT KIT
NSN 2590-01-436-9144**



**PLS
MOUNTING KIT
NSN 1005-01-523-6549**

Weapon Station Mounting Information for FMTV LTAS and HEMTT A4's

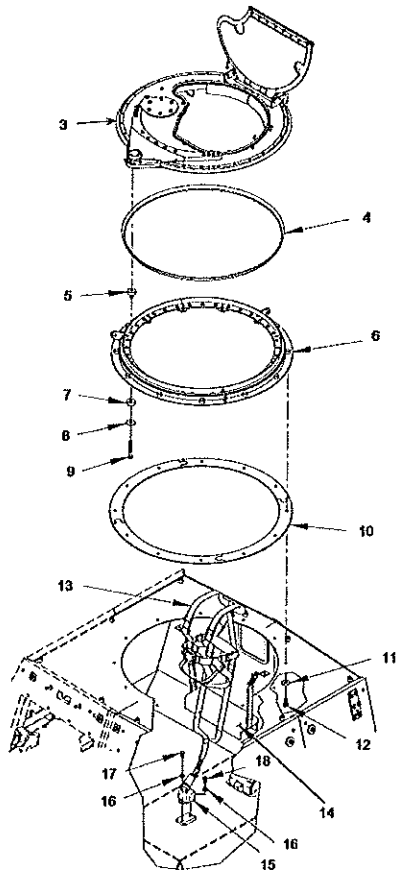

- 1 - 2 THROUGH 19
- 2 - 3 THROUGH 9
- 19 - 13 THROUGH 18

The M-66 Ring Mount will bolt directly to the roof of the LTAS cab. This ring will allow weapon mounting only. Mounting of an OGPK is never possible when using an M-66 Ring. To mount an OGPK on the LTAS cab, the Weapon Station Kit is needed, (PN 57K6026; NSN 2510-01-567-8727).

Item	PN	NSN	Description
1	57K6026	2510-01-567-8727	Kit, Weapon Station
2	12505884	N/A	• Weapon Station Assembly
3	12505891	2510-01-578-4322	-Turret, Ring Assembly
5	4668958-1	5365-01-571-1041	-Bushing, Upper
7	4668958-2	5365-01-570-7459	-Bushing, Lower
8	12505366-004	5310-01-570-7676	-Washer, Snubber
9	AEB021375C00AW8A2	N/A	-Screw, Cap, Hexagon
4	12505479	5330-01-573-8894	-Seal, Wipe
6	12505480	1005-01-575-6054	-Ring, Interface
10	12505430	5330-01-567-9060	• Seal, Nonmetallic
11	12414473-016	5310-01-375-0659	• Washer, Flat
12	12505457-002	5306-01-567-6548	• Bolt, Machine
19	57K6027	2540-01-571-8576	• Kit, Gunner's Restraint
13	900-US-07301	4240-01-542-8160	-Safety Device, Person
14	13014413	2540-01-550-7246	-Seat, Vehicular
15	901-US-07301-1	2540-01-543-0747	-Assembly Kit, Vehicular
16	12422608-015		-Washer, Flat
17	B1821BH044F125N	5305-00-709-8523	-Screw, Cap, Hexagon
18	B1821BH044F100N	5305-00-709-8517	-Screw, Cap, Hexagon

Contact the following for additional information:

Jason DeCoster
 PM-MTV Logistics (LTAS)
 Comm: 586-282-6327
 DSN: 786-6327

****Note: The Weapon Station Transfer Kit PN 57K2756; NSN 1005-01-577-2656 includes all items above except Item 3 –Turret, Ring Assembly (PN 12505891).**

The HEMTT A4 variants do not accept the M-66 Ring Mount. Units must order PN 12505891, NSN 2510-01-578-4322, Turret, Ring Assembly to provide weapon stations to the HEMTT A4 fleet.

F
M
T
V
-
L
T
A
S

H
E
M
T
T