

Small Arms...

The Proper Sight-Weapon Mix

SORRY, I CAN'T WORK WITH YOU!

I'M HERE TO HELP YOU DO YOUR JOB!

I DON'T THINK WE WOULD BE A GOOD FIT.

IT'S NOT ME, IT'S YOU.

THE ARMY GIVES SOLDIERS ALL SORTS OF CHOICES OF SIGHTS, LASERS AND INFRARED ILLUMINATORS TO USE ON THEIR RIFLES, PISTOLS AND MACHINE GUNS.



BUT IT CAN BE DIFFICULT TO TELL WHAT CAN BE USED ON WHAT AND WHERE YOU GO TO GET INFO ON HOW TO MOUNT AND USE A DEVICE.



TO HELP END THAT CONFUSION, HERE'S A LIST OF SIGHTS, THEIR NSNs AND TMS, AND WHAT THEY CAN BE USED ON...



AN/PAQ-4 infrared aiming light (LIN A34938):

AN/PAQ-4A, NSN 5855-01-312-5160, TM 11-5855-297-12&P

AN/PAQ-4B, NSN 5855-01-361-1362, TM 11-5855-301-12&P

AN/PAQ-4C, NSN 5855-01-398-4315, TM 11-5855-301-12&P

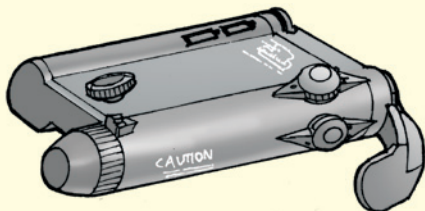

ALL THE AN/PAQ-4 VERSIONS CAN BE USED ON THE M16-SERIES RIFLE, THE M4/M4A1 CARBINE, AND THE M249 AND M240B MACHINE GUNS.

THE AN/PAQ-4 SERIES IS **NO LONGER SUPPORTED.**

USE IT UNTIL IT STOPS WORKING, THEN **REPLACE** IT WITH A DIFFERENT SIGHT.

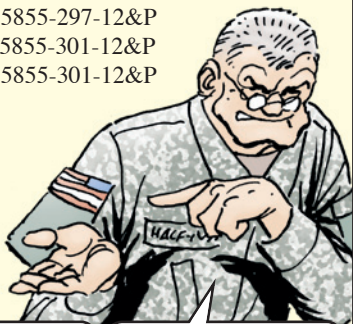

AN/PEQ-2 target pointer illuminator/aiming light (TPIAL) (LIN J03261):

AN/PEQ-2A, NSN 5855-01-447-8992, TM 9-5855-1915-13&P
AN/PEQ-2B, NSN 5855-01-515-6904, TM 9-5855-1915-13&P
AN/PEQ-2C, NSN 5855-01-515-6908, TM 11-5855-308-12&P

THE AN/PEQ SERIES CAN BE USED ON THE M16-SERIES RIFLE, THE M4/M4A1 CARBINE, AND THE M249, M240B, M2 AND MK 19 MACHINE GUNS.

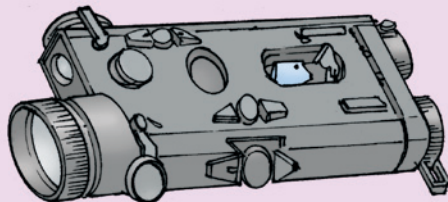

IT IS **NO LONGER SUPPORTED**. USE IT UNTIL IT STOPS WORKING AND THEN CHOOSE A **DIFFERENT SIGHT**.



AN/PEQ-14 integrated laser white light pointer (ILWLP) (LIN J68403):

AN/PEQ-14 (tan), NSN 5855-01-571-1258, TM 9-5855-1911-13&P
AN/PEQ-14 (black), NSN 5855-01-538-0191, TM 9-5855-1911-13&P

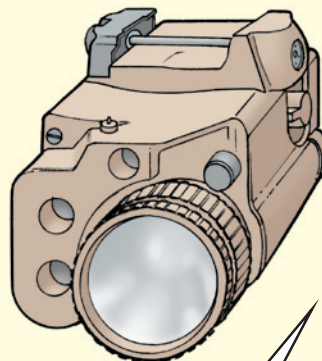

THE AN/PEQ-14 IS USED ONLY ON THE M9 PISTOL IN MP UNITS.

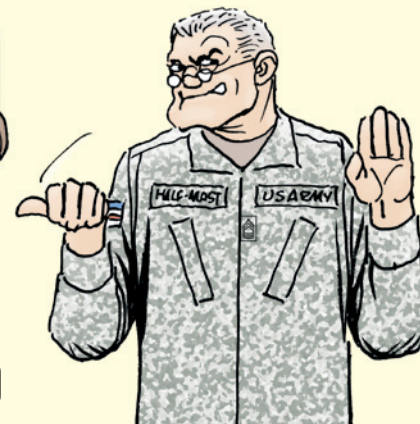

AN/PEQ-15 multi-functional aiming light NSN 5855-01-537-6000 (family) (LIN J03261):

AN/PEQ-15 (tan), NSN 5855-01-577-7174, TM 9-5855-1914-13&P*
AN/PEQ-15 (black), NSN 5855-01-534-5931, TM 9-5855-1914-13&P*
AN/PEQ-15A (green) dual-beam aiming laser-advanced (DBAL), NSN 5855-01-579-0062, TM 9-5855-1912-13&P*
AN/PEQ-15A (black) DBAL, NSN 5855-01-535-6166, TM 9-5855-1912-13&P*

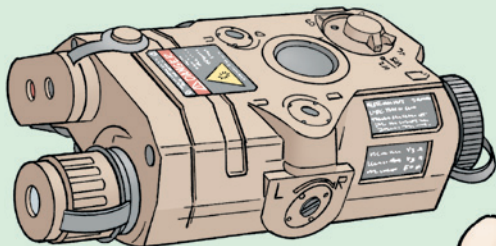

THE AN/PEQ-15 AND -15A CAN BE USED ON THE M16-SERIES RIFLE, THE M4/M4A1 CARBINE, AND THE M249, M240B, M2 AND MK 19 MACHINE GUNS.

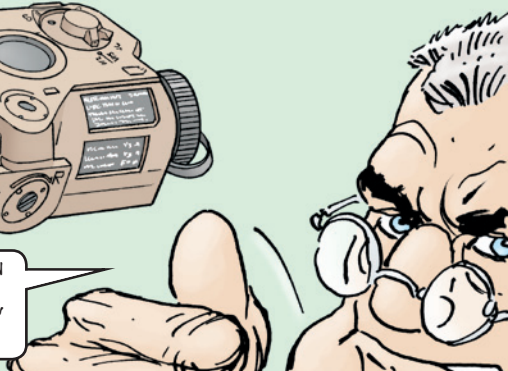

Laser borelight system (LBS):

AN/PEM-1 (no LIN), NSN 5860-01-471-2091, TM 9-5860-226-13&P
M30 (LIN B60351), NSN 4933-01-394-7781, TM 9-4933-273-12&P

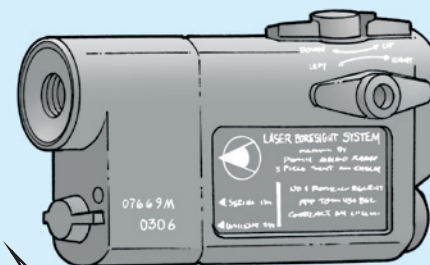

THE AN/PEM-1 IS USED ON ALL SMALL ARMS AND IS AUTHORIZED THROUGH THE CTA.

THE M30 IS **NO LONGER SUPPORTED**. IT'S BEEN REPLACED BY THE AN/PEM-1.

*To be included in the next TM update.

**AN/PSQ-23 small tactical optical rifle mounted (STORM)
micro laser range finder (MLRF) (LIN J68653):**

AN/PSQ-23 (tan), NSN 5855-01-577-5946, TM 9-5855-1913-13&P
AN/PSQ-23 (black), NSN 5855-01-535-1905, TM 9-5855-1913-13&P

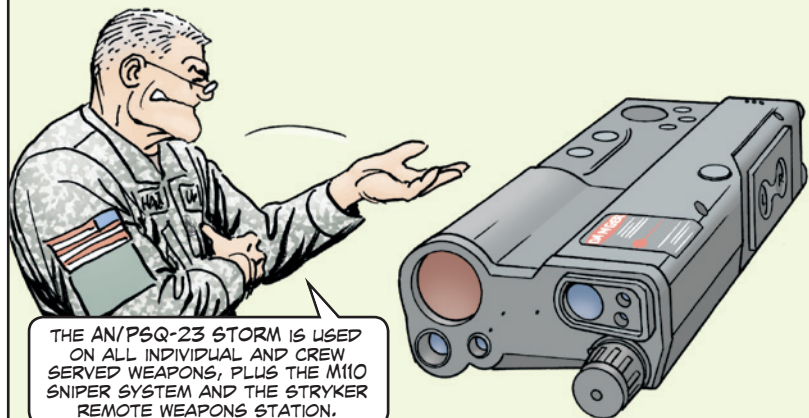

THE AN/PSQ-23 STORM IS USED ON ALL INDIVIDUAL AND CREW SERVED WEAPONS, PLUS THE M110 SNIPER SYSTEM AND THE STRYKER REMOTE WEAPONS STATION.

AN/PAS-13 medium weapon thermal sight (MWTS) (LIN S90535):

AN/PAS-13B(V)2, NSN 5855-01-464-3152, TM 11-5855-312-10
AN/PAS-13C(V)2, NSN 5855-01-523-7713, TM 11-5855-316-10
AN/PAS-13D(V)2, NSN 5855-01-524-4313, TM 11-5855-317-10

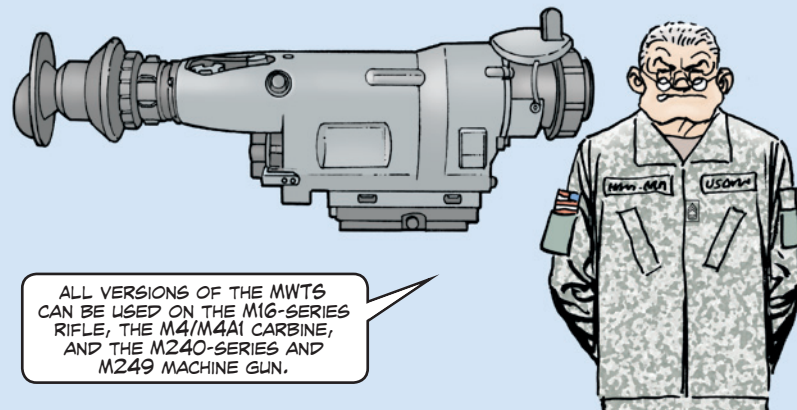

ALL VERSIONS OF THE MWTS CAN BE USED ON THE M16-SERIES RIFLE, THE M4/M4A1 CARBINE, AND THE M240-SERIES AND M249 MACHINE GUN.

AN/PAS-13 light weapon thermal sight (LWTS) (LIN S60356):

AN/PAS-13C(V)1, NSN 5855-01-523-7707, TM 11-5855-316-10
AN/PAS-13D(V)1, NSN 5855-01-524-4308, TM 11-5855-324-10

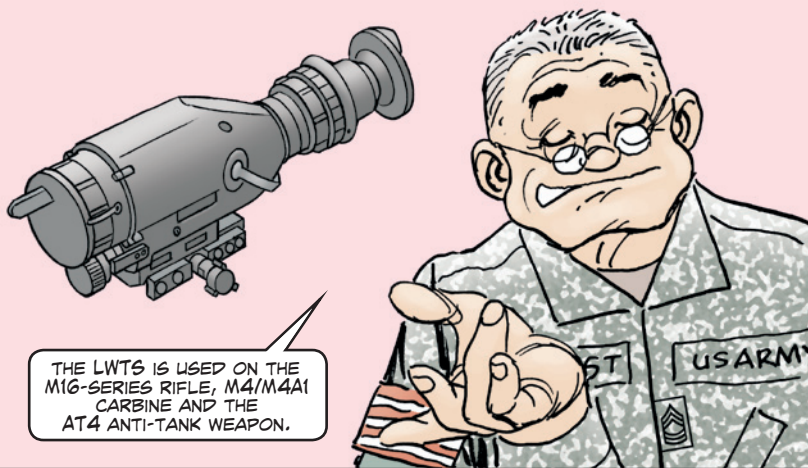

THE LWTS IS USED ON THE M16-SERIES RIFLE, M4/M4A1 CARBINE AND THE AT4 ANTI-TANK WEAPON.

AN/PAS-13 heavy weapon thermal sight (HWTS) (LIN S90603):

AN/PAS-13B(V)3, NSN 5855-01-464-3151, TM 11-5855-312-10
AN/PAS-13C(V)3, NSN 5855-01-523-7715, TM 11-5855-316-10
AN/PAS-13D(V)3, NSN 5855-01-524-4314, TM 11-5855-317-10

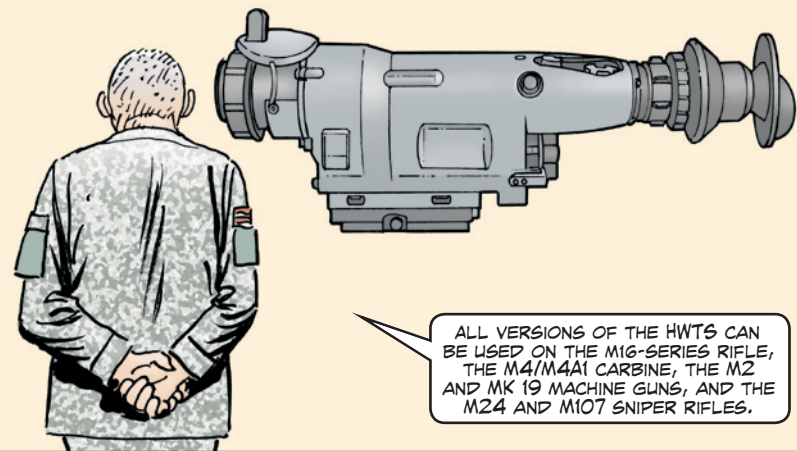

ALL VERSIONS OF THE HWTS CAN BE USED ON THE M16-SERIES RIFLE, THE M4/M4A1 CARBINE, THE M2 AND MK 19 MACHINE GUNS, AND THE M24 AND M107 SNIPER RIFLES.

AN/PVS-4 night vision sights (LIN N04732):

AN/PVS-4, NSN 5855-00-629-5334
AN/PVS-4A, NSN 5855-01-422-8782
Both are covered by TM 11-5855-213-10.

THE AN/PVS-4 AND -4A CAN BE USED ON THE M16-SERIES RIFLE, THE M4/M4A1 CARBINE, AND THE M249 AND M240B MACHINE GUNS.

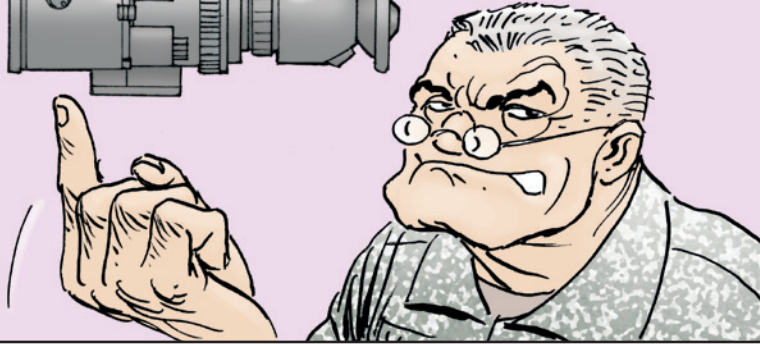
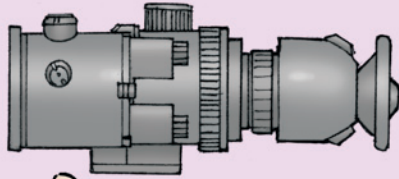

Night vision sniper scope (LIN S90433):

AN/PVS-10(V)1, NSN 5855-01-410-8979, TM 11-5855-303-12&P

THE AN/PVS-10(V)1 IS USED ONLY ON THE M24 SNIPER RIFLE.

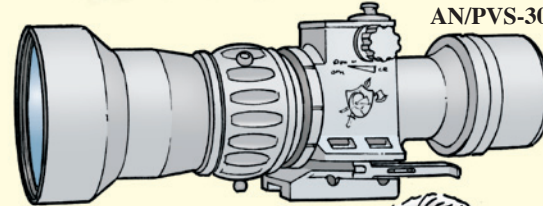
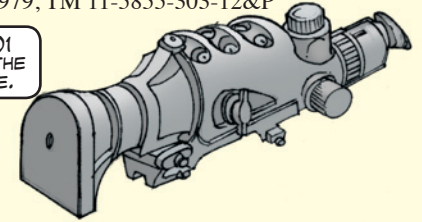

AN/PVS-30, NSN 5855-01-567-9243,
TM 9-5855-1916-13&P

THE AN/PVS-30 IS USED ONLY ON THE M110 SNIPER SYSTEM.

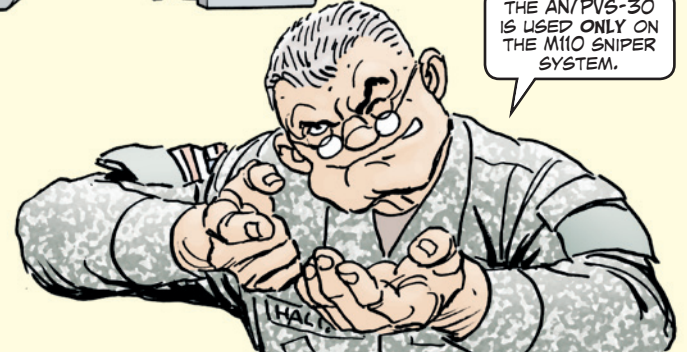

AN/TVS-5 night vision sights (LIN N04596):

AN/TVS-5, NSN 5855-00-629-5327, TM 11-5855-214-10
AN/TVS-5A, NSN 5855-01-422-8777, TM 11-5855-214-10

BOTH SIGHTS CAN BE USED ON THE M2 AND MK 19 MACHINE GUNS.

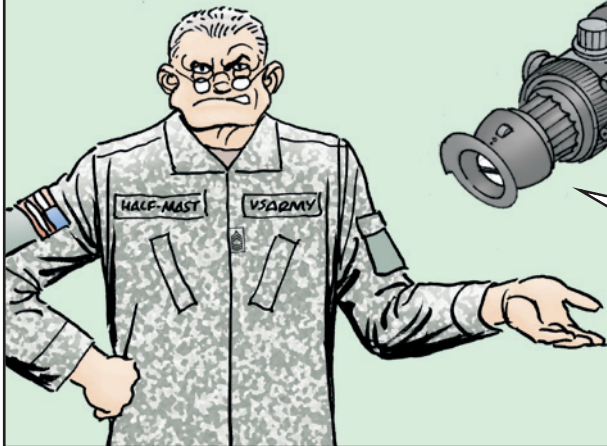
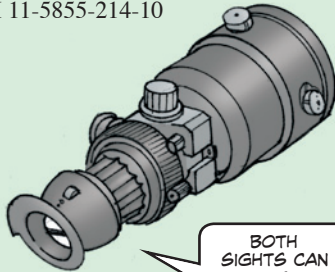

AN/PVS-14 monocular night vision device (LIN M79678):

AN/PVS-14, NSN 5855-01-432-0524, TM 11-5855-306-10

THE AN/PVS-14 IS USED ON THE M16A2 RIFLE, WHERE IT'S MOUNTED BEHIND THE M68 SIGHT.

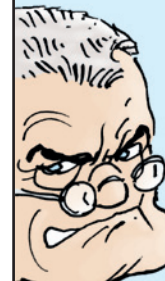
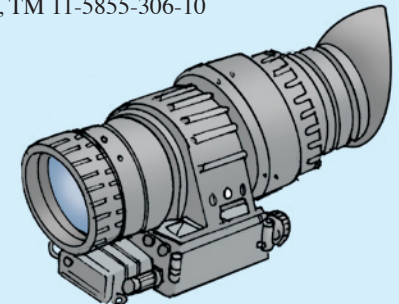

Reflex sight, M68 close combat optic (CCO) (LIN S60288):

M68 compM2, NSN 1240-01-411-1265, TM 9-1240-413-13&P

M68 compM4, NSN 1240-01-540-3690, TM 9-1240-413-13&P

M68 compM4S, NSN 1240-01-576-6134, TM 9-1240-413-13&P

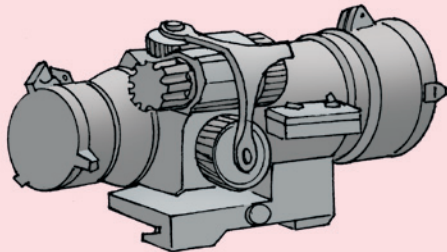

ALL VERSIONS OF THE M68 CAN BE USED ON THE M16-SERIES RIFLE AND THE M4/M4A1 CARBINE.

THE COMPM2 AND COMPM4 VERSIONS ARE **NO LONGER SUPPORTED**. REPLACE THEM WITH THE COMPM4S WHEN THEY NO LONGER WORK.

Rifle combat optic (RCO) sight (LIN S45729):

M150 RCO,

NSN 1240-01-557-1897,

TM 9-1240-416-13&P

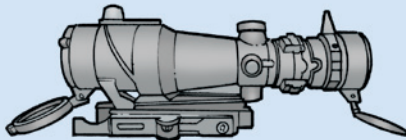

THE M150 CAN BE USED ON THE M16-SERIES RIFLE, THE M4/M4A1 CARBINE, AND M249 MACHINE GUN.

M145 straight telescope (LIN T60185):

M145,

NSN 1240-01-411-6350,

TM 9-1240-415-13&P

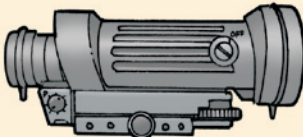

THE M145 IS USED ON THE M240-SERIES MACHINE GUN.

ANY TIME YOU HAVE QUESTIONS ABOUT WHAT YOU CAN OR CAN'T USE ON YOUR WEAPON...

...CHECK OUT THE SMALL ARMS INTEGRATION BOOK, WHICH CAN BE ACCESSED AT:
<https://www.us.army.mil/suite/folder/4718898>

