

TECHNICAL MANUAL

**TRANSPORTABILITY GUIDANCE
TRANSPORT OF CARGO ON THE RAILCAR
FLAT, 140-TON-CAPACITY
(NSN 2220-01-58-6377)**

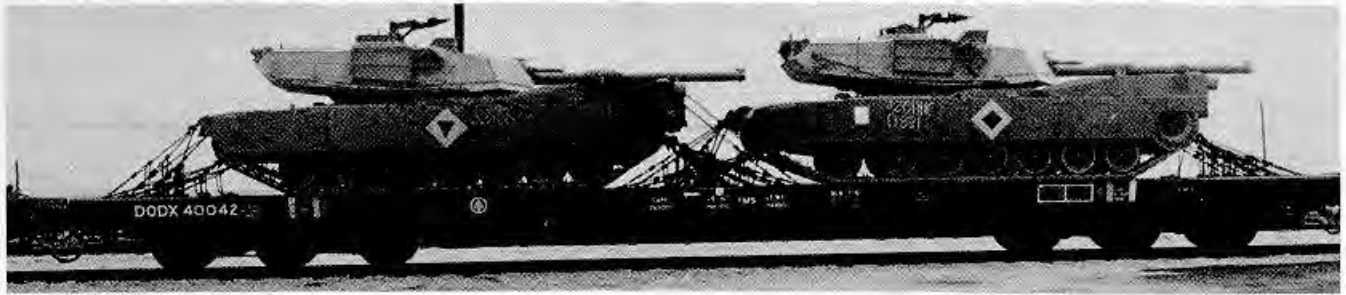

HEADQUARTERS, DEPARTMENT OF THE ARMY

9 JANUARY 1987

TECHNICAL MANUAL }
 No. 55-2220-058-14 }

HEADQUARTERS
 DEPARTMENT OF THE ARMY
 WASHINGTON, DC, 9 January 1987

**TRANSPORTABILITY GUIDANCE
 TRANSPORT OF CARGO ON THE RAILCAR,
 FLAT, 140-TON-CAPACITY
 (NSN 2220-01-058-6377)**

	<i>Paragraph</i>	<i>Page</i>
CHAPTER 1. INTRODUCTION		
Purpose and Scope	1-1	1-1
Reporting of Recommendations and Comments	1-2	1-1
Safety	1-3	1-1
Definitions of Warnings, Cautions, and Notes	1-4	1-1
2. TRANSPORTABILITY DATA		
Scope	2-1	2-1
Description	2-2	2-1
Preparation of the Flatcar	2-3	2-3
General Tiedown Instructions.....	2-4	2-3
Securing Tiedown Devices to Empty Cars	2-5	2-4
CHAPTER 3. SAFETY AND GENERAL INSTRUCTIONS		
SECTION I. SAFETY		
Chain Tiedown Inspection.....	3-1	3-1
Safety Instructions	3-2	3-1
II. GENERAL INSTRUCTIONS		
Hazardous and Dangerous Characteristics.....	3-3	3-1
Freight Classification	3-4	3-1
CHAPTER 4. TRANSPORT OF ONE OR TWO M1 (GENERAL ABRAMS) TANKS		
Scope	4-1	4-1
General	4-2	4-1
Loading M1 Tanks	4-3	4-1
5. TRANSPORT OF ONE OR TWO M60-SERIES TANKS OR M728 COMBAT ENGINEER VEHICLES		
Scope	5-1	5-1
General	5-2	5-1
Loading M60-Series Tanks	5-3	5-1
Loading M728 Combat Engineer Vehicles	5-4	5-7
6. TRANSPORT OF ONE OR TWO M88 RECOVERY VEHICLES		
Scope	6-1	6-1
General	6-2	6-1
Loading M88 Recovery Vehicles	6-3	6-1
7. TRANSPORT OF ONE OR TWO M109-SERIES SELF-PROPELLED HOWITZERS		
Scope	7-1	7-1
General	7-2	7-1
Loading M109-Series Self-Propelled Howitzers.....	7-3	7-1
8. TRANSPORT OF CONTAINERS		
Scope	8-1	8-1
General	8-2	8-1

*This manual supersedes TM 55-2220-058-14, 1 January 1984 and Interim. Change No. 101, 4 October 1985.

APPENDIX

A. REFERENCE S A-1
 B. MANUFACTURER PARTS LIST B-1

LIST OF ILLUSTRATIONS

Figure No.	Title	Page
2-1	Plan and side view of 140-ton flatcar	2-2
2-2	Diagram for securing tiedown devices empty cars.....	2-7
2-3	Assembly A	2-8
2-4	Assemblies B and C	2-9
2-5	Assembly D	2-10
4-1	Chain tiedown arrangement for one M1 tank	4-2
4-2	Chain tiedown arrangement for two M1 tanks facing the same direction	4-4
4-3	Wire rope securement of M1 gun tube (suggested)	4-5
4-4	Front view of M1 tanks loaded and restrained on 140-ton DODX flatcar	4-6
4-5	Rear view of M1 tank loaded and restrained on 140-ton DODX flatcar	4-7
4-6	Between tank arrangements of chain tiedown devices.....	4-8
5-1	Chain tiedown arrangement for one M60 tank	5-2
5-2	Front view of M60 tank loaded and restrained on 140-ton DODX flatcar	5-3
5-3	Rear view of M60 tank loaded and restrained on 140-ton DODX flatcar	5-4
5-4	Chain tiedown arrangement for two M60 tanks facing the same direction	5-6
5-5	Chain tiedown arrangement for one M728 combat engineer vehicle and one M60 tank	5-8
6-1	Chain tiedown arrangement for one M88 recovery vehicle	6-2
6-2	Chain tiedown arrangement for two M88 recovery vehicles	6-4
6-3	Front view of M88 recovery vehicle loaded and restrained on 140-ton DODX flatcar.....	6-5
6-4	Closeup of alternating hook placement on center-front ring of M88	6-6
6-5	Rear view of M88 recovery vehicle loaded and restrained on 140-ton DODX flatcar	6-7
6-6	Three shackle arrangement for center-front tiedown of M88	6-8
7-1	Chain tiedown arrangement for One M109 self-propelled howitzer	7-2
7-2	Chain tiedown arrangement for two M109 howitzers.....	7-4
8-1	Three 20-foot ISO containers secured in pedestals	8-2
8-2	One 40-foot ISO container and one 20-foot ISO container secured in pedestals.....	8-3
B-1	Ratchet handle	B-2
B-2	Anchor/chain assembly	B-3
B-3	Alloy shackle	B-4
B-4	Alloy master ring	B-5

Table No.	Title	Page
4-1	Bill of Materials for Loading and Securing One M1 Tank	4-9
4-2	Application of Materials for Securing One M1 Tank	4-9
4-3	Application of Materials for Securing Two M1 Tanks Loaded Front to Tail	4-10
4-4	Application of Materials for Securing One M1 Tank Facing the Opposite Direction from that Shown in Figure 4-1 (For location of "items" refer to fig 4-1).....	4-11
4-5	Application of Materials for Securing Two M1 Tanks Facing the Opposite Direction from that Shown in Figure 4-2 (For location of "items" refer to fig 4-2)	4-11
5-1	Bill of Materials for Loading and Restraining One M60 Series Tank	5-9
5-2	Application of Materials for Loading and Securing One M60 Tank (Fig 5-1).....	5-9
5-3	Application of Materials for Loading and Securing Two M60 Tanks (Fig 5-2).....	5-10
5-4	Application of Materials for Loading and Securing One M60 Series Tank Facing the Opposite Direction from that Shown in Figure 5-1	5-10
5-5	Application of Materials for Securing Two M60 Series Tanks Facing the Opposite Direction from that Shown in Figure 5-2.....	5-11
5-6	Bill of Materials for Loading and Securing One M728 Combat Engineer Vehicle and One M60 Tank.....	5-12
5-7	Application of Materials for Loading and Securing One M728 Combat Engineer Vehicle and One M60 Tank (Fig 5-5)	5-12
5-8	Application of Materials for Loading and Securing One M728 Combat Engineer Vehicle and One M60 Series Tank Facing the Opposite Direction from that Shown in Figure 5-3	5-14
6-1	Bill of Materials for Loading and Securing One M88 Recovery Vehicle	6-9
6-2	Application of Materials for Securing One M88 Recovery Vehicle (Fig 6-1)	6-9
6-3	Application of Materials for Securing Two M88 Recovery Vehicles (Fig 6-2)	6-9

Table No.	Title	Page
6-4	Application of Materials for Securing One M88 Recovery Vehicle Facing the Opposite Direction from that Shown in Figure 6-1 (For location of "items" refer to fig 6-1).....	6-10
6-5	Application of Materials for Securing Two M88 Recovery Vehicles Facing the Opposite Direction from that Shown in Figure 6-2 (For location of "items" refer to fig 6-2).....	6-11
7-1	Bill of Materials for Loading and Securing One M109 Self-Propelled Howitzer	7-5
7-2	Application of Materials for Securing One M109 Self-Propelled Howitzer (Fig 7-1).....	7-5
7-3	Application of Materials for Securing Two M109 Self-Propelled Howitzers (Fig 7-2)	7-6
7-4	Application of Materials for Securing One M109 Howitzer Facing the Opposite Direction from that Shown in Figure 7-1 (For location of "items" refer to fig 7-1)	7-6
7-5	Application of Materials for Securing Two M109 Howitzers Facing the Opposite Direction from that Shown in Figure 7-2 (For location of "items" refer to fig 7-2)	7-7

CHAPTER 1 INTRODUCTION

1-1. Purpose and Scope

a. This manual provides guidance for transporting certain military cargo and containers on the 68-foot, 140-ton, chain-tiedown DODX flatcar. Included are procedures for loading, tying down, and unloading items of military equipment and containers that are likely to be transported on the 140-ton flatcar. This manual is intended for use by transportation officers or other persons responsible for shipping or receiving military cargo in CONUS.

b. In special situations, other tracked vehicles may be transported on the 140-ton flatcar. However, before a new loading procedure can be adopted, detailed drawings and photographs must be submitted to MTMCTEA for analysis. Write to the address in paragraph 1-2 or call commercial (804) 599-1107, AUTOVON 927-4646, or FTS 988-4646 for specifics.

c. Where appropriate, metric equivalents are shown in parentheses following dimensions or other measurements. References are cited in the appendix.

1-2. Reporting of Recommendations and Comments

Users of this manual are asked to submit comments and recommended changes for its improvement. Comments and recommendations should be listed on DA Form 2028, Recommended Changes to Publications and Blank Forms, and sent to Commander, Military Traffic Management Command Transportation Engineering Agency, ATTN: MTTTR (F. Mika), PO Box 6276, Newport News, Virginia 23606-0276. Electrically transmitted messages should be addressed to CDR MTMCTEA FT EUSTIS VA/MTT-TR//.

1-1

1-3. Safety

Safety measures are prescribed in chapter 3 and in other chapters as required.

1-4. Definitions of Warnings, Cautions, and Notes

When used in this manual, warnings, cautions, and notes emphasize important or critical guidance. They are used for the following conditions:

- a. *Warning.* Instructions that, if not followed, could result in injury to or death of personnel.
- b. *Caution.* Instructions that, if not strictly observed, could result in damage to, or destruction of, equipment.
- c. *Note.* An operating procedure that must be emphasized.

CHAPTER 2 TRANSPORTABILITY DATA

2-1 Scope

This chapter contains the description, characteristics, and other data pertaining to the 68-foot, 140ton, chain-tiedown DODX flatcar, which will be referred to throughout this manual as either "the flatcar" or "the car." This chapter also provides necessary data for proper loading and use of the flatcar.

2-2. Description

a. *General.* The 140-ton flatcar is a heavy-duty, six-axle flatcar, with end-of-car cushioning to reduce impact loads on the cargo. Its metal deck has four lengthwise channels that holds 50 chain-tiedown assemblies, two of which are spares. Each chain tiedown assembly consists of an anchor that is movable in the channels, two coupling links, a loadbinder (turnbuckle), a compression unit, and another coupling link, which is attached to a ½ inch-wide alloy-steel chain, about 6 ½ feet (1.98 m) long, with a sling hook on the load attachment end and a claw hook on the loadbinder end. Twelve 4inch-diameter shackles and two 7-inch-diameter rings are furnished loose with each car. (See app B, figs B-1 through B-3.) One additional ring or shackle is required per M88.

b. *Dimension.* The flatcar, including the couplers, is about 874 inches (22.20 m) long. Its cargo deck is 816 inches (20.73 m) long. The deck width of flatcars with serial numbers 40000 through 40100 is 123 inches (3.12 m); the deck width of flatcars with serial numbers 40101 and up is 125 inches (3.17 m). The ends of all flatcars taper to about 117 inches (2.97 m). The cargo deck is 48 inches (1.22 m) high, measured from the top of the rail. Plan and side views are shown in figure 2-1.

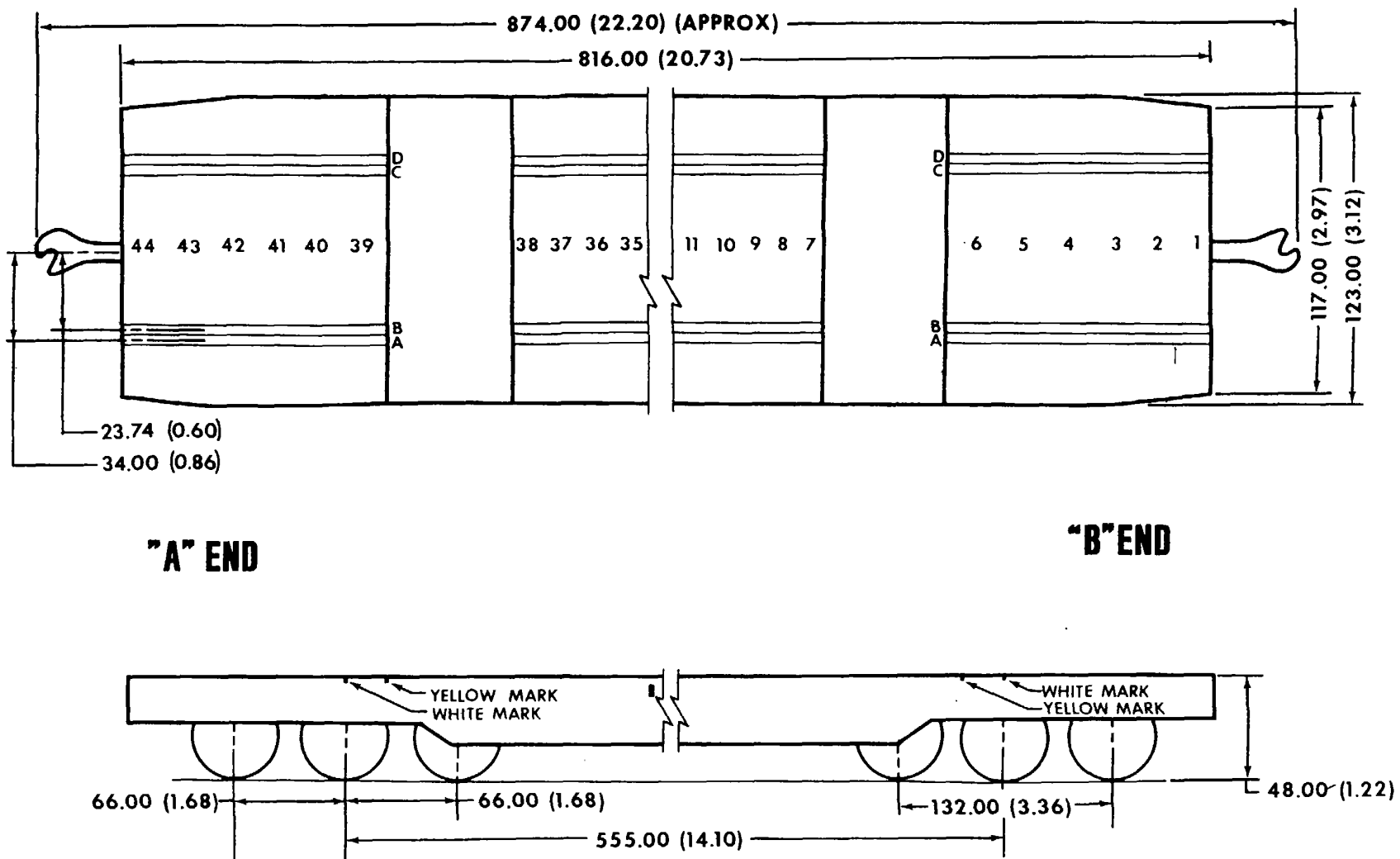

NOTE: ALL DIMENSIONS ARE IN INCHES AND (METERS)
 THE DECK WIDTH OF FLATCARS WITH SERIAL NUMBERS 40000-40100 IS 123 INCHES (3.12 M)
 THE DECK WIDTH OF ALL OTHERS IS 125 INCHES (3.17 M)

Figure 2-1. Plan and side View of 140-ton flatcar.

c. *Tiedown Locations.* Tiedown locations on the flatcar are numbered, at 15-inch intervals, and the channels for the chain tiedown anchors are lettered. The tiedown location numbers, starting with 1 and ending with 44, are stenciled lengthwise along the cargo deck. Two outboard channels, marked A and D, are 34 inches (.86 m) from the car centerline. Two inboard channels, marked B and C, are 23 9/10 inches (.60 m) from the car centerline. Four additional tiedown positions are located between each of the 44 marked positions; each tiedown position is spaced 3 inches (.08 m) apart; therefore, if the chain anchor location calls for 24 3/5, the anchor should be positioned three notches past location 24. The tiedown location numbers and the channel identification letters are also shown in figure 2-1. The required or recommended chain-tiedown anchor locations, for each load, are given in tiedown diagrams and tiedown data tables in this manual.

d. *Capacity.* The flatcar is classified as a 140ton-capacity flatcar. The actual load limit stenciled on the side of the car varies between 299,000 lbs. and 301,000 lbs.

e. *Handbrake.* A ratchet-type handbrake lever is located on the side of the car, below the level of the deck. In this position, the brake lever, which is operated from the ground, does not interfere with loading or unloading.

2-3. Preparation of the Flatcar

- a. Before Loading.
- (1) Remove rocks, leaves, or other trash from the channels so that the chain anchors will slide freely.
 - (2) Pull all the chains needed for tiedown out of the channels, and slide the chain anchors along the bottom of the channels to the required locations on inside channels only.
 - (3) Lock the chain anchors at the proper location on inside channels only.
 - (4) Drop outboard anchors and loadbinders into outside channels after completion of steps 5 and 6. Let the balance of these chain assemblies lie on the deck between the channels.

NOTE

To lock the chain anchor in position, the tabs at each end of the anchor must be rotated up and moved sideways to retract the movable pins in the anchor; the anchor must be lifted to completely seat the notches in the channel. The chain must be held in that position, and the tabs at each end of the anchor must be moved sideways to extend the movable TM 55-2220-058-14 pins so they rest on top of the channel. Then the tabs must be rotated down and into the recess.

- (5) Lubricate turnbuckle threads and eyebolts with "Rust Veto" Corrosion Preventative Compound MIL-C-16173, Grade 4 or equivalent.
- (6) Turn each turnbuckle body until both eyebolts are fully extended (the turn buckle ends have a built-in stop).
- (7) Lay all turnbuckles on inside channels to point inboard toward the center of the car, and pile the chain for each turnbuckle between the channels.

CAUTION

Do not leave any part of the chain assembly (including the turnbuckles) on the treadway area, where it could be run over by the vehicle being loaded or unloaded.

- b. Before Unloading.
- (1) Use a liquid mist or penetrating lubricant to help loosen jamnuts.
 - (2) Place the chain assemblies in the center of the car.
 - (3) Leave, securely stowed on the car, items furnished with the flatcar, such as tiedowns, shackles, and rings.

2-4. General down Instructions

- a. Drive the tank over the end ramp or lift the tank or other vehicle onto the flatcar in accordance with the appropriate tiedown-arrangement figure.

CAUTION

If loading is to be done from a side ramp, damage to chain tiedown devices from tracked vehicle treads will result unless one of the following procedures is used: (1) Wooden deck flatcars are spotted next to the side ramp. Vehicles can be driven onto the wooden deck car, pivoted, and driven onto the steel deck car. (2) The 140-ton flatcars next to the side ramp have all of their chain assemblies, shackles, and rings temporarily removed.

- b. Attach shackles and/or rings as required.
- c. Place chain hooks with nose down in shackles and/or rings as required. Pull chains as tight as possible, by hand, before hooking the claw hook. (Chains must not be kinked or twisted.)
- d. Hand tighten loadbinders starting with the lowest chain on the shackle or ring. Then continue to tighten the loadbinders with a 1½-inch openend wrench, a 15-inch crescent wrench, or a ratch et handle (spanner wrench). The

spanner wrench, Mac-Lean-Fogg part number 61011, has a ratchet type action that markedly reduces tightening time. (See app B.) Sources for this wrench are: L. L. & C. Inc., PO Box 74, Clarendon Hills, IL 60514; Mac Lean-Fogg Co., 1000 Allanson Road, Mundelein, IL 60060; and John Sakash Co., 433 Romans Road, Elmhurst, IL 60126.

e. Tighten loadbinders of front and rear tiedowns at the same time to avoid disturbing the tank position. Tighten each chain until only one eighth inch of rubber is visible between the metal rings in the compression unit. After tensioning, strike the chain with a hammer or steel bar with enough force to eliminate any kinks in the chain. Retighten if necessary. Tighten the jamnut against the loadbinder; torque to at least 70 foot-pounds. This requires two wrenches.

f. After tiedowns have been tensioned, lubricate exposed turnbuckle threads and jamnuts again with "Rust Veto" Corrosion Preventative Compound MIL-C-16173, Grade 4 or equivalent.

WARNING

After tiedowns are completed, (1) shackle pins must be securely wired to the shackles to prevent loosening in transit, (2) pintles must have pintle lock secured with a cotter key or wire, and (3) unused chain assemblies must be stowed in channels.

2-5. Securing idown Devoies to Empty Cars

a. Chains, shackles, and rings on empty cars must be secured to the flatcar so they will not become free, endangering material or persons along the railroad right-of-way.

b. The chain securement system is arranged in four assemblies: A, B, C, and D. These assemblies are illustrated in figures 2-2 through 2-5, respectively.

(1) Assembly A.

a. Channel D-Move the chain that is closest to anchor position D7 to position D7-this will usually be near position D19. If a spare chain is between D19 and D7, use it. (The chain placed in position D7 will be a crossover chain.) Move the chain anchors of the chains on the B end of the car to positions 1, 2, and 3 of channels A, B, C, and D.

b. Unscrew the loadbinder (turnbuckle) of the crossover chain to its minimum length.

c. In the middle of the crossover chain, attach two shackles with a ring in between. Tighten the shackle pins, and place the shackles so their pin eyes are against the desk.

d. Arch the crossover chain so the apex is nearest the B end of the car, and insert the hook end in the end of channel A near position A7.

e. Hook the three chains in channels A (positions 1, 2, and 3) to the shackle nearest channel B on the crossover chain.

f. Hook the six chains in channels B and C (positions 1, 2, and 3) to the ring in the center of the crossover chain.

g. Hook the three chains in channel D (positions 1, 2, and 3) to the shackle nearest channel D on the crossover chain.

h. Shorten and tighten the crossover chain as much as possible with the claw hook. Do not tighten the other chains at this time.

i. Ensure the shackle pin eyes are against the deck.

j. Screw up the loadbinder on the crossover chain until it is taut and the shackles cannot be moved by hand. (All chain hooks must be in their respective shackles and rings.)

k. Pull each of the remaining chains as short as possible, and hold them in place with the claw hooks. Tighten the loadbinders on each chain to make then taut.

2. Assembly B.

a. Channel A-Move the chain that is closest to anchor position A12 to position A12-this will usually be near position A19. If a spare chain is between A19 and A7, use it. (The chain placed in position A12 will be a crossover chain.) Move the remaining middeck chains to form two symmetrical arrays, with anchor position 22 as the vacant midpoint. Place the B end array in positions 21, 20, and 19 of channels A, B, C, and D. Place the A end array in positions 23, 24, and 25 of channels A, B, C, and D; these chains will be used in assembly C.

b. Unscrew the loadbinder (turnbuckle) of the crossover chain to its maximum length.

c. Arch the crossover chains so the apex is near the middle of the car, and insert the hook end in the outside pedestal hole adjacent to position 12D.

d. Attach four shackles in the middle of the crossover chain. Tighten the shackle pins, and place the shackles so their pin eyes are against the deck.

(e). Hook the chains in channel A (positions 21, 20, and 19) to the shackle nearest channel B on the crossover chain (two to three chains subject to spare).

(f) Hook the three chains in channel B (positions 21, 20 and 19) to the second shackle from channel B on the crossover chain.

(g) Hook the three chains in channel C (positions 21, 20, and 19) to the third shackle from channel B on the crossover chain.

(h) Hook the chains in channel D (positions 21, 20, and 19) to the shackle nearest channel C on the crossover chain (two to three chains subject to spare).

(i) Shorten and tighten the crossover chain as much as possible with the claw hook. Do not tighten the other chains at this time.

(j) Ensure the shackle pin eyes are against the deck.

(k) Screw up the loadbinder on the crossover chain until it is taut and the shackles cannot be moved by hand. (All chain hooks must be in their respective shackles.)

(l) Pull each of the remaining chains as short as possible and hold them in place with the claw hooks. Tighten the loadbinders on each chain to make them taut.

(3) Assembly C.

(a) Channel A-Move the chain that is closest to anchor position A33 to position A33-this will usually be near position A26. If a spare chain is between A26 and A38, use it. (The chain placed in position A33 will be a crossover chain.) For placement of remaining chains in this assembly, see paragraph 2-5b(2)(a).

(b) Unscrew the load binder (turnbuckle) of the crossover chain to its maximum length.

(c) Attach two shackles, with a ring in between, in the middle of the crossover chain. Tighten the shackle pins, and place the shackles so their pin eyes are against the deck.

(d) Arch the crossover chain so the apex is nearest the A end of the car, and insert the hook end in the outside pedestal hole adjacent to position 33D.

(e) Hook the chains in channel A (positions 23, 24, and 25) to the shackle nearest channel B on the crossover chain (two to three chains subject to spare).

(f) Hook the six chains in channels B and C (positions 23, 24, and 25) to the ring in the center of the crossover chain.

(g) Hook the chains in channel D (positions 23, 24, and 25) to the shackle nearest channel C on the crossover chain (two to three chains subject to spare).

(h) Shorten and tighten the crossover chains as much as possible with the claw hook. Do not tighten the other chains at this time.

(i) Ensure the shackle pin eyes are against the deck.

(j) Screw up the loadbinder on the crossover chain until it is taut and the shackles cannot be moved by hand. (All chain hooks must be in their respective shackles and rings.) (k) Pull each of the remaining chains as short as possible, and hold them in place with the claw hooks. Tighten the loadbinders on each chain to make them taut.

(4) Assembly D.

(a) Channel D-Move the chain that is closest to anchor position D38 to position D38-this will usually be near position D26. If a spare chain is between D26 and D38, use it. (The chain placed in position D26 will be a crossover chain.) Move the chain anchors of the chains on the A end of the car to positions 44, 43, and 42 in channels A, B, C, and D.

(b) Unscrew the loadbinder (turnbuckle) of the crossover chain to its maximum length.

(c) Arch the crossover chain so the apex is near the middle of the car, and insert the hook end in channel A near position A38.

(d) Attach four shackles in the middle of the crossover chain. Tighten the shackle pins and place the shackles so the shackle pin eyes are against the deck.

(e) Hook the three chains in channel A (positions 44, 43, and 42) to the shackle nearest channel B on the crossover chain.

(f) Hook the three chains in channel B (positions 44, 43, and 42) to the shackle second from channel B on the crossover chain.

(g) Hook the three chains in channel C (positions 44, 43, and 42) to the shackle third from channel C on the crossover chain.

(h) Hook the three chains in channel D (positions 44, 43, and 42) to the shackle nearest channel C on the crossover chain.

(i) Shorten and tighten the crossover chains as much as possible with the claw hook. Do not tighten the other chains at this time.

(j) Ensure the shackle pin eyes are against the deck.

(k) Screw up the loadbinder on the crossover chain until it is taut and the shackles cannot be moved by hand. (All chain hooks must be in their respective shackles.)

(l) Pull each of the remaining chains as short as possible, and hold them in place with the claw hooks. Tighten the loadbinders on each chain to make them taut.

c. If one vehicle is moved on a flatcar, the chains in the middle of the car will be used to tie down the vehicle and those on the ends of the car must remain secured in a necklace arrangement. On cars with at least two spare chains, the spares will be used as crossover chains and placed in channel D positions 7 and 38 as described in assemblies A and D for an empty car at figure 2-2.

d. If a car has only 48 chains, all 24 chains in the center of the car must be used to tie down the vehicle (except the M109 self-propelled howitzers, which use only 12 chains). Since this leaves no chains available to cross over the deck to secure chains, shackles, and rings at the end of the car, the chain assemblies, with anchors, near positions D3 and D42 must be removed and placed at positions D7 and D38. These will become the crossover chains. At this point, follow the crossover procedures identified in assemblies A and D of figure 2-2.

NOTE 1

You will find that, when a single M1 tank or M88 recovery vehicle is moved, positions D7 and D38 are identified as tiedown points. Therefore, no room is left for the crossover chain used to secure the chains, shackles, and rings. When this occurs, simply move the chains used for tying down the vehicle from positions D7 to D8 and D38 to D37. This will allow use of the crossover chain to secure loose equipment at the ends of the car without jeopardizing the safety of the vehicle.

NOTE 2

If the tiedown procedures prescribed in this manual for loaded and empty cars are followed, very few instances of losses of chains, shackles, or rings, should occur. Nevertheless, accountability for chains, shackles, and rings is specified in MTMC operational notice No. 123, dated 221300Z Mar 85. This implements DA policy as outlined in DA MSG 181522Z Feb 84, subj: accountability for chains, rings, and shackles on 140-ton rail flatcars. Detailed instructions pertaining to accountability for chains, shackles, and rings also can be found in chapter 25 of the Defense Traffic Management Regulation upon its publication.

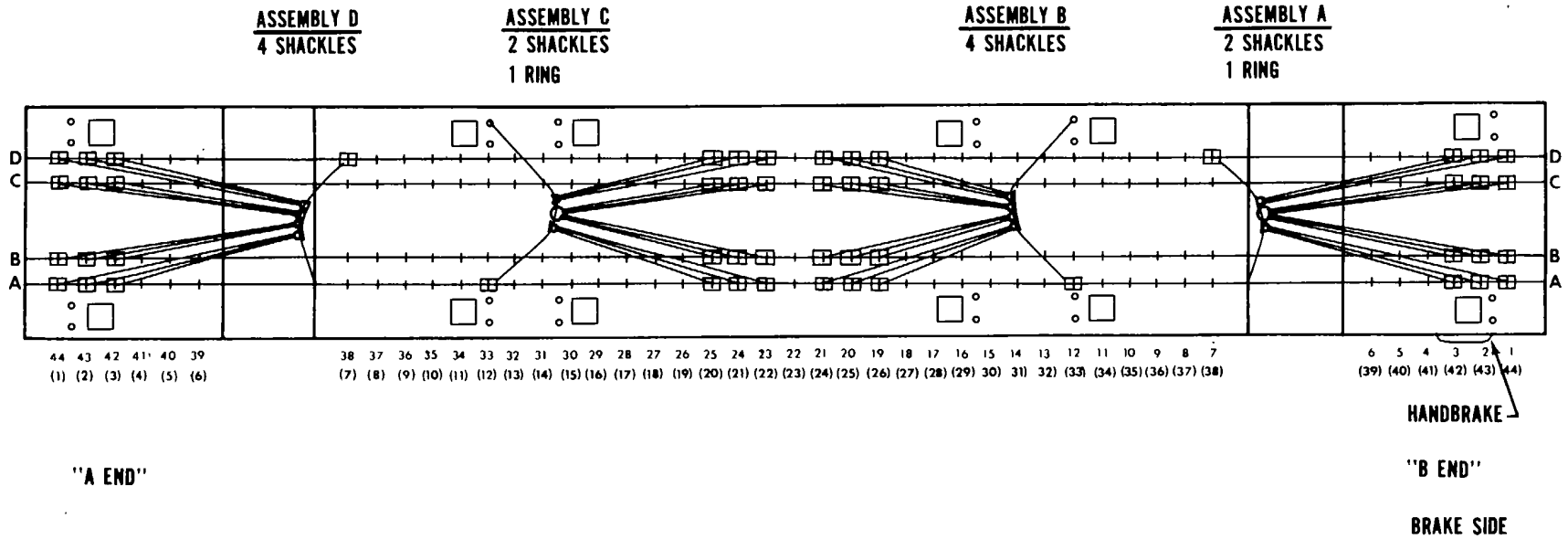

Figure 2-2. Diagram for securing tiedown devices to empty car.

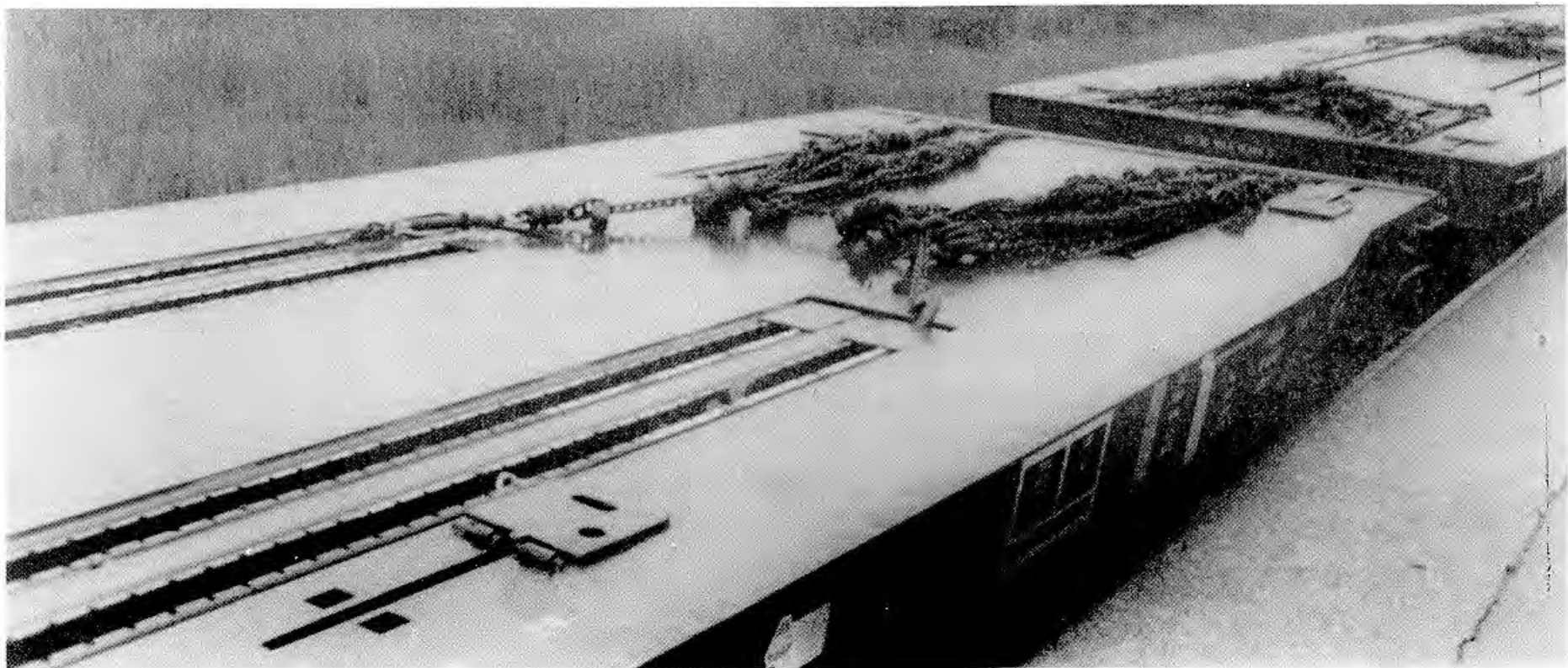

Figure 2-3. Assembly A.



Figure 2-4. Assemblies B and C.

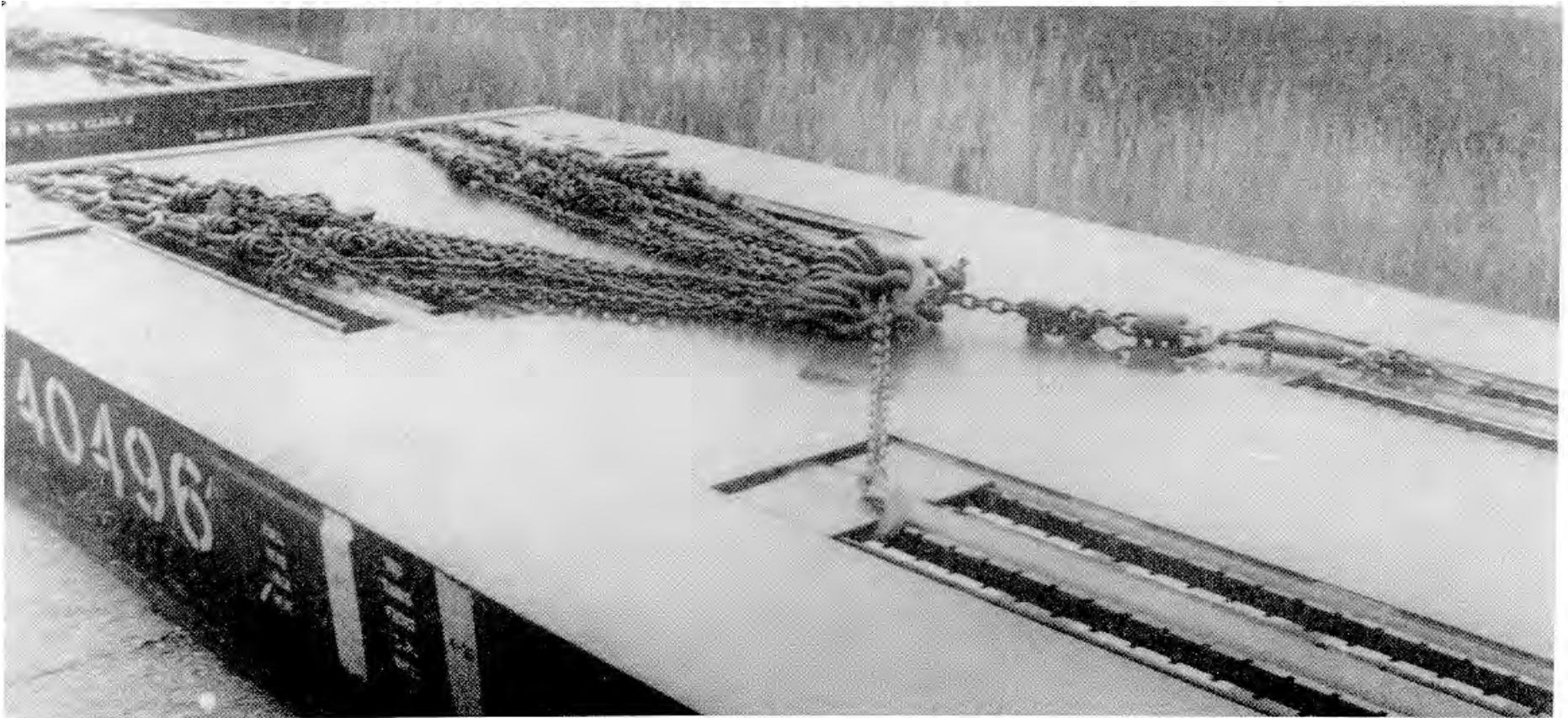

Figure 2-5. Assembly D.

CHAPTER 3 SAFETY AND GENERAL INSTRUCTIONS

Section I. SAFETY

3-1. Chain Tiedown Inspection

Each chain assembly that is to be used must be inspected to determine apparent breaks, cracks, gouges, open welds, or deformed components. Special attention must be given to the connector link that attaches the chain to the anchor fitting. If defects are found, the chain and/or fittings must be replaced. If all components are free of apparent damage, an eight-link segment next to the turnbuckle end of the chain should be compared with an eight-link segment near the hook fitting at the load attachment end of the chain assembly. If the eight-link segment near the hook fitting at the load attachment end is one-half inch or longer than the eight-link segment near the turnbuckle end, the chain has stretched beyond normal limits (4 percent) and should be replaced.

3-2. Safety Instructions

These instructions apply to the transport of all vehicles discussed in this manual. Other safety measures are prescribed in each chapter, as required.

- a. The vehicles must be driven by qualified drivers only.
- b. The vehicles must not be mounted or dismounted while in motion.
- c. Personnel must not ride on the vehicles.
- d. A ground guide must be used during all loading and unloading operations.
- e. Personnel must stay clear of the exhaust area during and immediately after engine operation. Contact with these areas can cause severe burns.
- f. Engines must not be operated in an enclosed area without adequate ventilation.
- g. Personnel must stay clear of the tank turret when it is being traversed.

Section II. GENERAL INSTRUCTIONS

3-3. Hazardous and Dangerous Characteristics

The vehicles discussed in this manual will not present any special hazardous or dangerous characteristics during transportation by rail.

NOTE

Those regulations and/or transportation procedures normally associated with vehicles containing combustible liquid fuels will apply (Association of American Railroads, Rules Governing the Loading of Commodities on Open-Top Cars (app A)).

3-4. Freight Classification

Rail-freight classification description and item number will be determined in accordance with chapter 211, AR 55-355. Proper classification and/ or description of vehicles or equipment must be determined and provided on the bill of lading before the shipment is released to the railroad.

CHAPTER 4 TRANSPORT OF ONE OR TWO M1 (GENERAL ABRAMS)

4-1. Scope

This chapter provides guidance of transport of one or two M1 tanks on the 140-ton flatcar and prescribes the loading and tiedown procedures.

4-2. General

The M1 tank is 113.7 inches (2.89 m) high and 143.8 inches (3.65 m) wide. When the tank is loaded on the flatcar, its tracks extend about 7 inches (0.18 m) beyond each side of the car. The tank can be transported on the flatcar without major disassembly, but will require special routing by the railroads because its width exceeds the 128inch limit for unrestricted movement.

4-3. Loading M1 Tanks

a. A single M1 tank can be loaded onto the flatcar either by being driven onto the car over an end-loading ramp or by being lifted onto the car with a crane or cranes of at least 70to 75-ton capacity. The tank must be centered on the car, with the hub of the fourth left roadwheel positioned over the white mark on the side sill at the center of the car and with about equal overhang of the tank tracks on both sides of the flatcar. A difference of 1 inch between the left-side and right-side overhang is the maximum permitted by many railroad load inspectors. The chain tiedown arrangement for a single M1 tank is shown in figure 4-1. The bill of materials required to secure each M1 tank on the flatcar is provided in table 4-1. The application of materials and chain tiedowns for a single M1 tank is explained in table 4-2. If the tank is loaded facing the opposite direction from that shown in figure 4-1, apply the chain tiedown arrangement as explained in table 4-4.

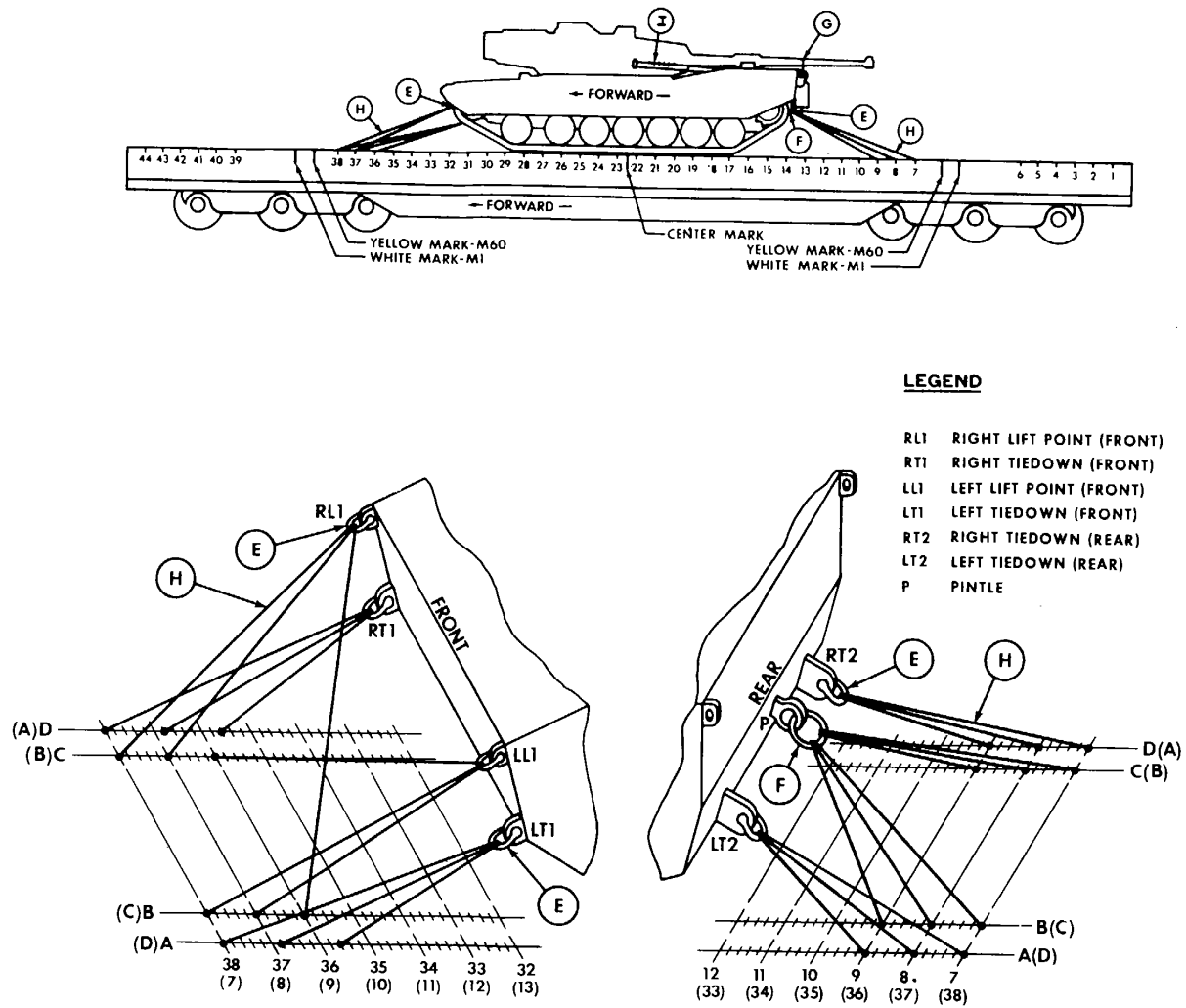

Figure 4-1. Chain tiedown arrangement for one M1 tank

b. Two M1 tanks can be loaded onto the flatcar by being driven or lifted onto the car. Both tanks must be centered over the centerline of the car so that the track overhang is about equal on both sides. Tank No. 1 must be positioned so that the front of the left front roadwheel is lined up behind the white mark on the front side of the car. Tank No. 2 must be positioned so that the rear of the left rear roadwheel is lined up behind the white mark at the other end of the car. These positions are depicted in figure 4-2. When driven or lifted onto the flatcar, both tanks will be facing the same direction and secured as shown in figure 4-2. The application of chain tiedowns for two M1 tanks facing the same direction is explained in table 4-3. Front, rear, and between-tanks chain arrangements are shown in figures 4-4 through 4-6, respectively. If one or two M1 tanks are loaded facing the opposite TM 55-2220-05814 direction from that shown in figures 4-1 and 4-2, the chain tiedowns for one tank will be applied as explained in table 4-4; or for two tanks, table 4-5.

NOTE

Chain anchor locations are painted along the four anchor channels: White for M1 tank(s) and yellow for M60 tank(s). When viewed from the left side of the tank(s), the two left channels depict correct chain anchor locations. The two right channels must be arranged in a mirror image of the two left channels to complete the four correct chain-anchor locations. After the chain anchors have been placed as prescribed above, the locations should be cross-checked with the applicable figures and tables to ensure accuracy.

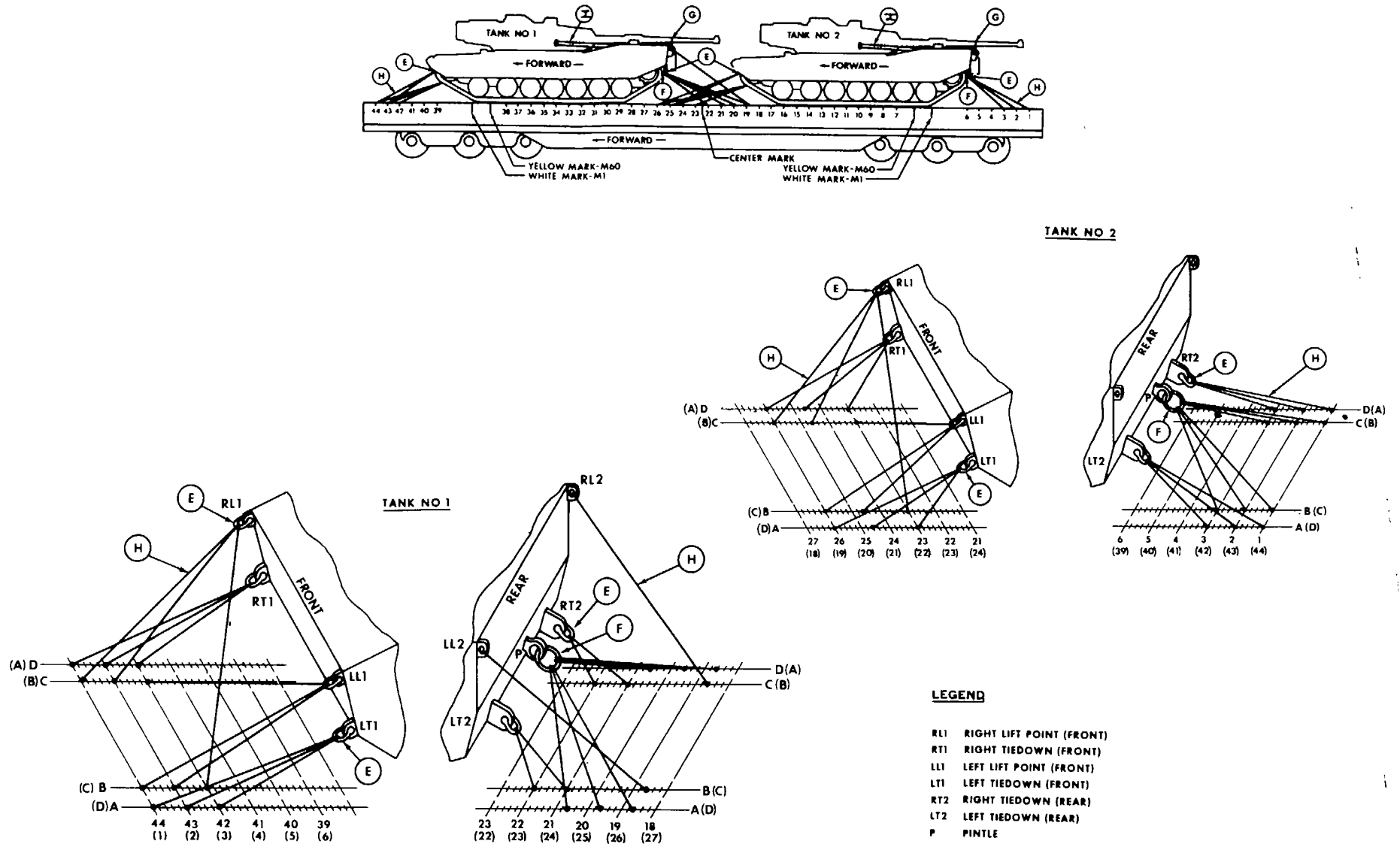

Figure 4-2. Chain tiedown arrangement for two M1 tanks facing the same direction.

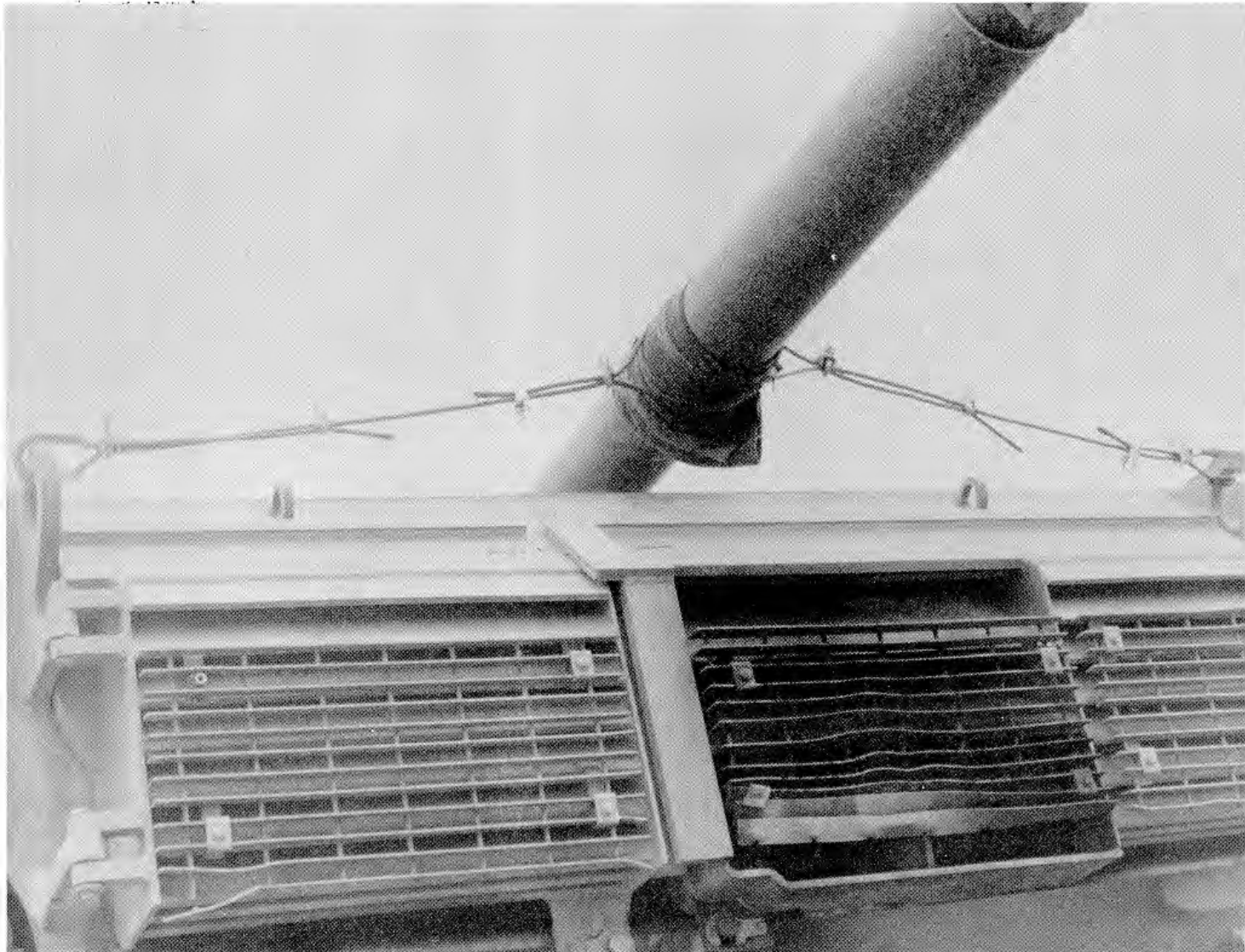

Figure 4-3. Wire rope securement of M1 gun tube (suggested).



Figure 4-4. Front view of M1 tanks loaded and restrained on 140-ton DODX flatcar.



Figure 4-5. Rear view of M1 tank loaded and restrained on 140-ton DODX flatcar.



Figure 4-6. Between-tanks arrangement of chain tiedown devices.

Table 4-1. Bill of Materials for Loading and Securing One M1 Tank

Item	Description	Approximate Quantity
Wire Rope	6 x 19 IWRC, improved plow steel, preformed, regular-lay; table X, Fed Spec RR-W-410: 3/8 inch	40 ft
Clips	Wire rope, U-bolt clips, saddled, single-grip, steel, Crosby heavy-duty or equal; MIL-STD-16842: 3/8-inch	4
Clips	Wire rope, U-bolt clips, saddled, single-grip, steel, Crosby heavy-duty or equal; MIL-STD-16842 5/8-inch	2
Shackles*	1 ½-inch-diameter wire size, 4-inch diameter inside bow, 2 3/8 inch entrance to bow, 1 3/8 -inch thread pin, alloy steel heat-treated to 170,000 pounds minimum break strength; MacLean-Fogg (M-F) 61284, or Midland Forge MK0267	6
Ring*	1 ¾-inch-diameter wire size, 7-inch-diameter inside, alloy steel heat-treated to 300,000 pounds minimum break strength, MacLean-Fogg (M-F) 61283, or equivalent	1
Thimbles	Standard, open type: 3/8-inch	2

*Furnished with flatcar.

Table 4-2. Application of Materials for Securing One M1 Tank (Fig 4-1)

item	No. Required	Application
A thru D		Channels. For description, refer to paragraph 2-2c.
E	6	Shackles. At front of tank, attach one shackle to each tiedown fitting and one shackle to each lift fitting. At rear of tank, attach one shackle to each tiedown fitting.
F	1	Ring. Attach to towing pintle at rear of tank.
G	2	Wire rope, 3/8-inch. Wrap gun tube with protective material. Place thimbles on lifting eyes and apply wire rope in two complete loops: one around gun tube to left-rear lifting eye, the other around gun tube to right-rear lifting eye. Pull loops hand tight and secure ends of each loop with two 3/8-inch U-bolt clips. Secure each thimble to wire rope with one 5/8-inch clip. (Not required if tank has operable external gun-tube brace.) See figure 4-3.
H	24	Chains. Furnished with flatcar. Apply chains between tank tiedown fittings and anchor locations on the deck of the car, as shown in figure 4-1 and described below.
I	2	Wire rope, 3/8-inch. If gun tube is not installed in the turret, secure turret to hull with 3/8-inch wire rope, to prevent turret rotation, and secure each loop with two 3/8-inch U-bolt clips.
LT1	3	Chains. Attach chains to the left-front tiedown fitting shackle from chain anchors in A35-3/5, A36-4/5, and A38.
RT1	3	Chains. Attach chains to the right-front tiedown fitting shackle from chain anchors in D35-3/5, D36-4/5, and D38.
LL1	3	Chains. Attach chains to the left-front lift fitting shackle from chain anchors in C36, B37, and B38.
RL1	3	Chains. Attach chains to the right-front lift fitting shackle from chain anchors in B36, C37, and C38.
LT2	3	Chains. Attach chains to the left-rear tiedown fitting shackle from chain anchors in A9, A8, and A7.
RT2	3	Chains. Attach chains to the right-rear tiedown fitting shackle from chain anchors in D9, D8, and D7.
P	6	Chains. Attach chains to the ring in the pintle from chain anchors in B9, B8, B7, C9, C8, and C7.

GENERAL INSTRUCTIONS

1. M1 tank brakes must not be set. Transmission selector must be in neutral.
2. Turret gun must be in the aft travel position, lowered, and locked in the gun elevation travel lock used for all modes of transportation and a cable (wire rope) used to secure gun tube while in transit. (The gun travel lock on the turret ceiling will be engaged to the gun breech to anchor the gun tube in zero elevation during vehicle transit, and the internal turret lock will be engaged in the locked position to prevent turret rotation.) Turret rotation and gun-elevating controls must be wire-tied, if feasible, to prevent movement of turret and gun.
3. Turnbuckles of front and rear chain tiedowns must be tightened at the same time to avoid disturbing the tank position.
4. Also applicable are General Rules 4, 5, 7, 11, 15(g), 19, 19A, and 19C in Section 1 of *the Rules Governing the Loading of Commodities on Open-Top Cars and Trailers*, published by the Association of American Railroads. These general rules are also found in TM 55-2200 001-12.

Table 4-3. Application of Materials for Securing Two M1 Tanks Loaded Front to Tail (Fig 4-2)

Item	No. Required	Application
A thru D		Channels. For description, refer to paragraph 2-2c.
E	12	Shackles. At front of tank, attach one shackle to each tiedown fitting and one shackle to each lift fitting. At rear of tank, attach one shackle to each tiedown fitting.
F	2	Rings. Attach to towing pintles at rear of tanks.
G	4	Wire rope, 3/8-inch. Wrap gun tube with protective material. Place thimbles on lifting eyes and apply wire rope in two complete loops: one around gun tube to left-rear lifting eye, the other around gun tube to right-rear lifting eye. Pull loops hand tight and secure ends of each loop with two 3/8-inch U-bolt clips. Secure each thimble to wire rope with one 5/8-inch clip. (Not required if tank has operable external gun-tube brace.) See figure 4-3.
H	48	Chains. Furnished with flatcar. Apply chains between tank tiedown fittings and anchor locations on the deck of the car, as shown in figure 4-2 and described below.
I	4	Wire rope, 3/8-inch. If gun tube is not installed in the turret, secure turret to hull with 3/8-inch wire rope, to prevent turret rotation, and secure each loop with two 3/8-inch U-bolt clips.
M1 TANK NO. 1		
LT1	3	Chains. Attach chains to the left-front tiedown fitting shackle from chain anchors in A42, A43, and A44.
RT1	3	Chains. Attach chains to the right-front tiedown fitting shackle from chain anchors in D42, D438, and D44.
LL1	8	Chains. Attach chains to the left-front lift fitting shackle from chain anchors in C42, B43, and B44.
RL1	3	Chains. Attach chains to the right-front lift fitting shackle from chain anchors in B42, C48, and C44.
LT2	2	Chains. Attach chains to the left-rear tiedown fitting shackle from chain anchors in B22 and B21.
RT2	2	Chains. Attach chains to the right-rear tiedown fitting shackle from chain anchors in C22 and C21.
P	6	Chains. Attach chains to the ring in the pintle from chain anchors in A20-3/5, A19-3/5, A18-3/5, D20-3/5, D19-3/5, and D18-3/5.
RL2	1	Chain. Attach chain to the upper right-rear lift fitting from chain anchor in C18-3/5.
LL2	1	Chain. Attach chain to the upper left-rear lift fitting from chain anchor in B18-3/5.
M1 TANK NO. 2		
LT1	3	Chains. Attach chains to the left-front tiedown fitting shackle from chain anchors in A28, A24-3/5, and A26.
RT1	3	Chains. Attach chains to the right-front tiedown fitting shackle from chain anchors in D23, D24-3/5, and D26.
LL1	3	Chains. Attach chains to the left-front lift fitting shackle from chain anchors in C28, B24-3/5, and B26.
RL1	3	Chains. Attach chains to the right-front lift fitting shackle from chain anchors in B23, C24-3/5, and C26.
LT2	3	Chains. Attach chains to the left-rear tiedown fitting shackle from chain anchors in A3, A2, and A1.
RT2	3	Chains. Attach chains to the right-rear tiedown fitting shackle from chain anchors in D3, D2, and D1.
P	6	Chains. Attach chains to the ring in the pintle from chain anchors in B3, B2, B1, C3, C2, and C1.

GENERAL INSTRUCTIONS

1. M1 tank brakes must not be set. Transmission selector must be in neutral.
2. Turret gun must be in the aft travel position, lowered, and locked in the gun elevation travel lock used for all modes of transportation, and a cable (wire rope) must be used to secure gun tube while in transit. (The gun travel lock on the turret ceiling will be engaged to the gun breech to anchor the gun tube in zero elevation during vehicle transit, and the internal turret lock will be engaged in the locked position to prevent turret rotation.) Turret rotation and gun-elevating controls must be wire-tied, if feasible, to prevent movement of turret and gun.
3. Turnbuckles of front and rear chain tiedowns must be tightened at the same time to avoid disturbing the tank position.
4. Also applicable are General Rules 4, 5, 7, 11, 15(g), 19, 19A, and 19C in Section 1 of the Rules Governing the Loading of Commodities on Open-Top Cars and Trailers, published by the Association of American Railroads. These general rules are also found in TM 55-220-001-12.

Table 4-4. Application of Materials for Securing One M1 Tank Facing the Opposite Direction from that Shown in Figure 4-1. (For location of "items, " refer to figure 4-1.)

Item	No. Required	Application
A thru D		Channels. For description, refer to paragraph 2-2c.
E	6	Shackles. At front of tank, attach one shackle to each tiedown fitting and one shackle to each lift fitting. At rear of tank, attach one shackle to each tiedown fitting.
F	1	Ring. Attach to towing pintle at rear of tank.
G	2	Wire rope, 3/8-inch. Wrap gun tube with protective material. Place thimbles on lifting eyes and apply wire rope in two complete loops: one around gun tube to left-rear lifting eye, the other around gun tube to right-rear lifting eye. Pull loops hand tight and secure ends of each loop with two 3/8-inch U-bolt clips. Secure each thimble to wire rope with one 5/8-inch U-bolt clip. (Not required if tank has operable external gun-tube brace.)
H	24	Chains. Furnished with flatcar. Apply chains between tank tiedown fittings and anchor locations on the deck of the car, as described below.
I	2	Wire rope, 3/8-inch. If gun tube is not installed in the turret, secure turret to hull with 3/8-inch wire rope, to prevent turret rotation, and secure each loop with two 3/8-inch U-bolt clips.
LT1 and D7.	3	Chains. Attach chains to the left-front tiedown fitting shackle from chain anchors in D9-2/5, D8-1/5, and D7.
RT1 and A7.	3	Chains. Attach chains to the right-front tiedown fitting shackle from chain anchors in A9-2/5, A8-1/5, and A7.
LL1	3	Chains. Attach chains to the left-front lift fitting shackle from chain anchors in B9, C8, and C7.
RL1	3	Chains. Attach chains to the right-front lift fitting shackle from chain anchors in C9, B8, and B7.
LT2 and D38.	3	Chains. Attach chains to the left-rear tiedown fitting shackle from chain anchors in D36, D37, and D38.
RT2	3	Chains. Attach chains to the right-rear tiedown fitting shackle from chain anchors in A36, A37, and A38.
P	6	Chains. Attach chains to the ring in the pintle from chain anchors in C36, C37, C38, B36, B37, and B38.

GENERAL INSTRUCTIONS

1. M1 tank brakes must not be set. Transmission selector must be in neutral.
2. Turret gun must be in the aft travel position, lowered, and locked in the gun elevation travel lock used for all modes of transportation, and a cable (wire rope) must be used to secure gun tube while in transit. (The gun travel lock on the turret ceiling will be engaged to the gun breech to anchor the gun, and the internal turret lock will be engaged in the locked position to prevent turret rotation). Turret rotation and gun-elevating controls must be wire-tied, if feasible, to prevent movement of turret and gun.
3. Turnbuckles of front and rear chain tiedowns must be tightened at the same time to avoid disturbing the tank position.
4. Also applicable are General Rules 4, 5, 7, 11, 15(g), 19, 19A, and 19C in Section 1 of the Rules Governing the Loading of Commodities on Open-Top Cars and Trailers, published by the Association of American Railroads. These general rules are also found in TM 55-2200-001-12.

Table 4-5. Application of Materials for Securing Two M1 Tanks Facing the Opposite Direction from that Shown in Figure 4-2. (For location of "items, " refer to figure 4-2.)

Item	No. Required	Application
A thru D		Numbered tiedown channels located on cargo deck of flatcar.
E	12	Shackles. At front of tank, attach one shackle to each tiedown fitting and one shackle to each lift fitting. At rear of tank, attach one shackle to each tiedown fitting.
F	2	Rings. Attach to towing pintle at rear of tank.

Table 4-5. Application of Materials for Securing Two M1 Tanks Facing the Opposite Direction from that Shown in Figure 4-2. (For location of "items, " refer to figure 4-2.)-Continued

Item	No. Required	Application
G	4	Wire rope, 3/8-inch. Wrap gun tube with protective material. Place thimbles on lifting eyes and apply wire rope in two complete loops: one around gun tube to left-rear lifting eye, the other around gun tube to right-rear lifting eye. Pull loops hand tight and secure ends of each loop with two 3/8-inch U-bolt clips. Secure each thimble to wire rope with one 5/8-inch U-bolt clip. (Not required if tank has operable external gun-tube brace.)
H	48	Chains. Furnished with flatcar. Apply chains between tank tiedown fittings and anchor locations on the deck of the car, as described below.
I	2 per tank	Wire rope, 3/8-inch. If gun tube is not installed in the turret, secure turret to hull with 3/8-inch wire rope, to prevent turret rotation, and secure each loop with two 3/8-inch U-bolt clips.
M1 TANK NEAR POSITION NO. 1		
LT1	3	Chains. Attach chains to the left-front tiedown fitting shackle from chain anchors in D3, D2, and D1.
RT1	3	Chains. Attach chains to the right-front tiedown fitting shackle from chain anchors in A3, A2, and A1.
LL1	8	Chains. Attach chains to the left-front lift fitting shackle from chain anchors in B3, C2, and C1.
RL1	8	Chains. Attach chains to the right-front lift fitting shackle from chain anchors in C3, B2, and B1.
LT2	2	Chains. Attach chains to the left-rear tiedown fitting shackle from chain anchors in C23 and C24.
RT	2	Chains. Attach chains to the right-rear lift tiedown fitting shackle from chain anchors in B23 and B24.
P	6	Chains. Attach chains to the ring in the pintle from chain anchors in D24-2/5, D25-2/5, D26-2/5, A24-2/5, A25-2/5, and A26-2/5.
LL2	1	Chain. Attach chain to upper left-rear lift fitting from chain anchor in C26-2/5.
RL2	1	Chain. Attach chain to upper left-rear lift fitting from chain anchor in B26-2/5.
M1 TANK NEAR POSITION NO. 44		
LT1	8	Chains. Attach chains to the left-front tiedown fitting shackle from chain anchors in D22, D20-2/5, and D19.
RT1	8	Chains. Attach chains to the right-front tiedown fitting shackle from chain anchors in A22, A20-2/5, and A19.
LL1	3	Chains. Attach chains to the left-front lift fitting shackle from chain anchors in B22, C20-2/5, and C19.
RL1	3	Chains. Attach chains to the right-front lift fitting shackle from chain anchors in C22, B20-2/5, and B19.
LT2	3	Chains. Attach chains to the left-rear tiedown fitting shackle from chain anchors in D42, D43, and D44.
RT2	3	Chains. Attach chains to the right-rear tiedown fitting shackle from chain anchors in A42, A43, and A44.
P	6	Chains. Attach chains to the ring in the pintle from chain anchors in C42, C43, C44, B42, B43, and B44.

GENERAL INSTRUCTIONS

1. M1 tank brakes must not be set. Transmission selector must be in neutral.
2. Turret gun must be in the aft travel position, lowered, and locked in the gun elevation travel lock used for all modes of transportation, and a cable (wire rope) must be used to secure gun tube while in transit. (The gun travel lock on the turret ceiling will be engaged to the gun breech to anchor the gun tube in zero elevation during vehicle transit, and the internal turret lock will be engaged in the locked position to prevent turret rotation.) Turret rotation and gun-elevating controls must be wire-tied, if feasible, to prevent movement of turret and gun.
3. Turnbuckles of front and rear chain tiedowns must be tightened at the same time to avoid disturbing the tank position.
4. Also applicable are General Rules 4, 5, 7, 11, 15(g), 19, 19A, and 19C in Section 1 of *the Rules Governing the Loading of Commodities on Open-Top Cars and Trailers*, published by the Association of American Railroads. These general rules are also found in TM 55-2200-01-12.

CHAPTER 5 TRANSPORT OF ONE OR TWO M60-SERIES TANKS FOR M728 COMBAT ENGINEER VEHICLES

5-1. Scope

This chapter provides guidance for transport of one or two M60-series tanks or M728 combat engineer vehicles on the 140-ton flatcar and prescribes the loading and tiedown procedures.

5-2. General

The M60-series tank is 143 inches (3.63 m) wide and varies in height from 126.3 inches (3.20 m) to 130.3 inches (3.31 m), depending on the model. The M728 combat engineer vehicle with bulldozer blade is 143 inches (3.63 m) wide and 128.3 inches (3.26 m) high. When either vehicle is loaded on the flatcar, its tracks extend about 8.5 inches (0.22 m) beyond each side of the car. The M60-series tank and the M728 combat engineer vehicle can be transported on the flatcar without major disassembly, but will require special routing by the railroads because their widths exceed the 128-inch limit for unrestricted movement.

5-3. Loading M60-Series Tanks

a. A single M60 tank can be loaded onto the flatcar either by being driven onto the car over an end-loading ramp or by being lifted onto the car with a crane or cranes of at least 60-ton capacity. The tank must be centered on the car, with about equal overhang of its tracks on both sides of the car. A difference of 1 inch between the left-side and right-side overhang is the maximum permitted by many railroad load inspectors. The tank must be positioned so that the white mark at the center of the flatcar side is centered between the third and fourth roadwheels. The chain tiedown arrangement for a single M60 tank is shown in figure 5-1. Front and rear chain arrangements are shown in figures 5-2 and 5-3, respectively. The bill of materials required to secure each M60 tank on the flatcar is provided in table 5-1. The application of the materials and chain tiedowns for a single M60 tank is explained in table 5-2.

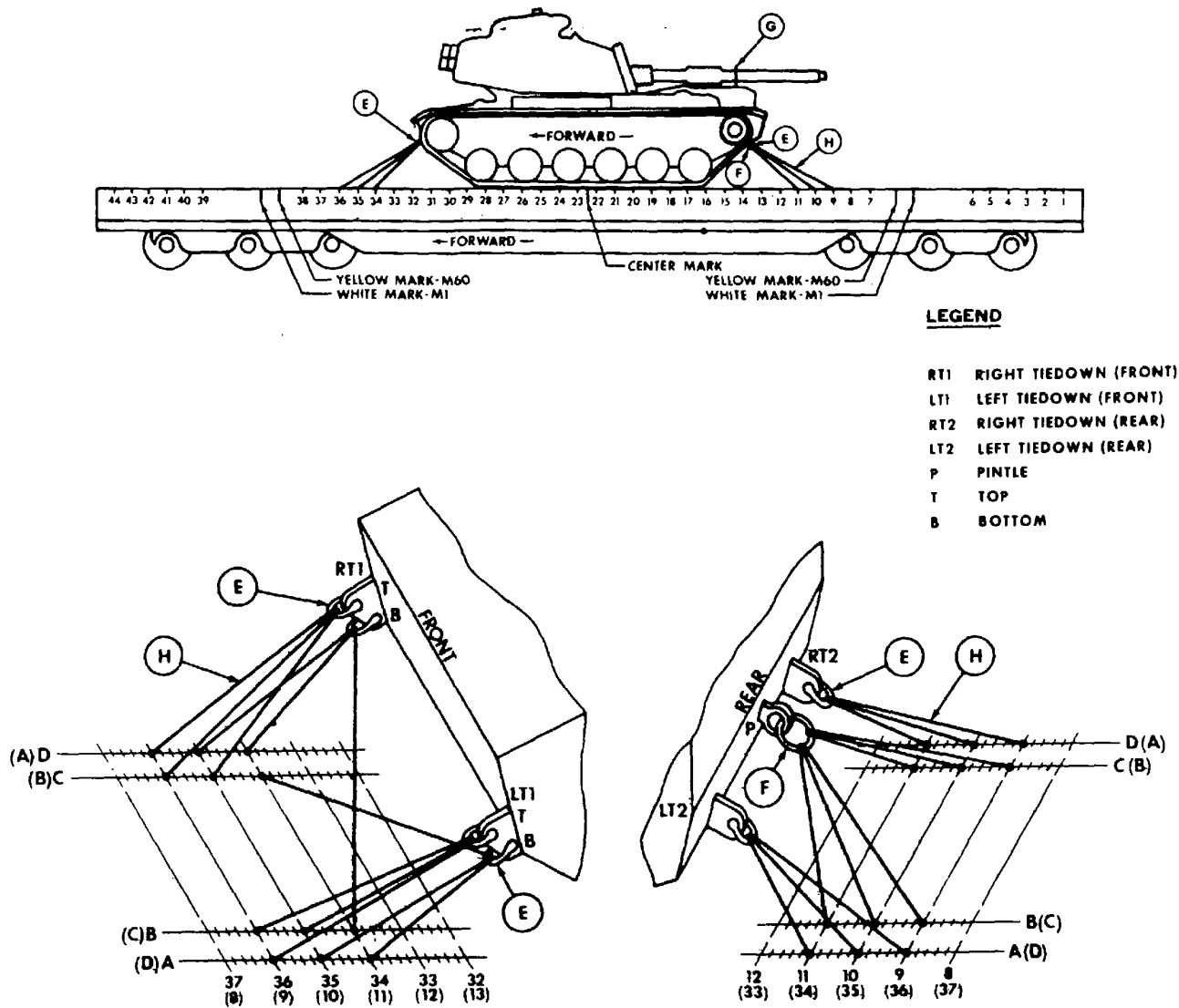

Figure 5-1. Chain tiedown arrangement for one M60 tank.

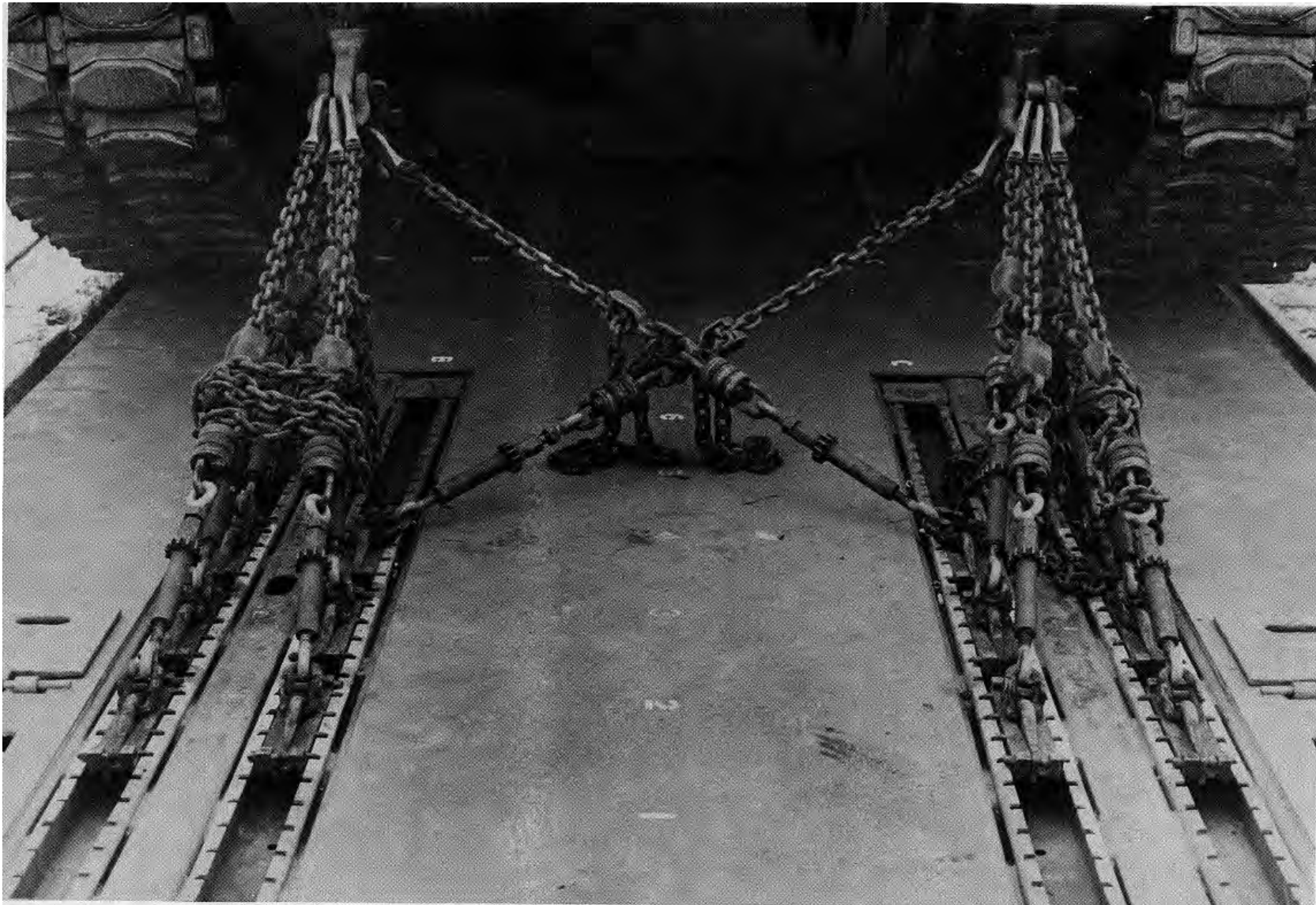

Figure 5-2. Front view of M60 tank loaded and restrained on 140-ton DODX flatcar.

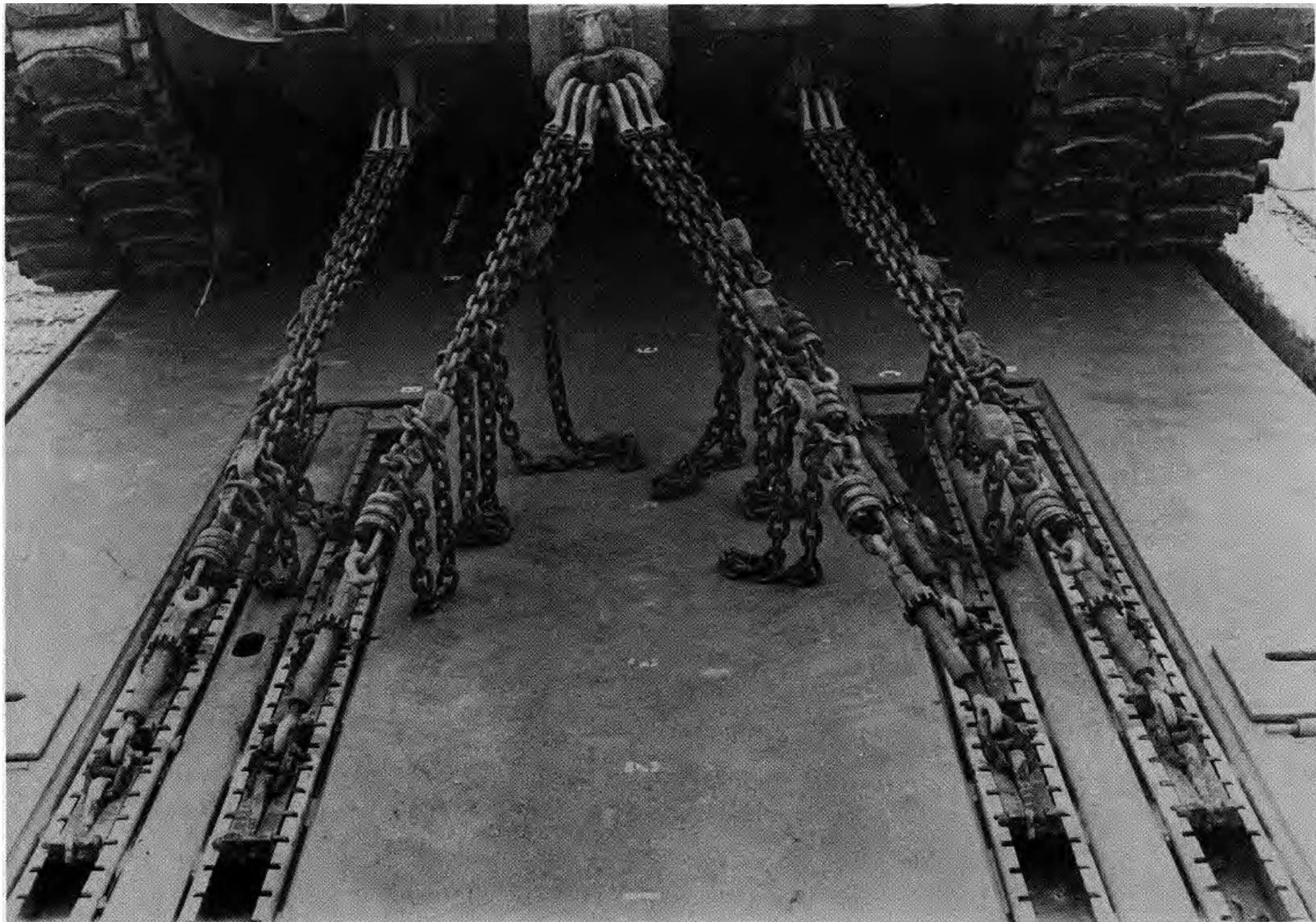
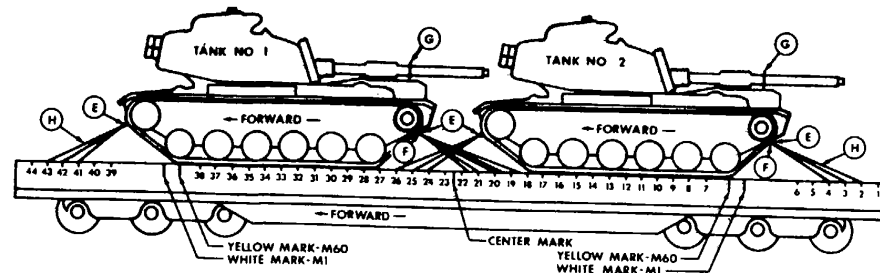
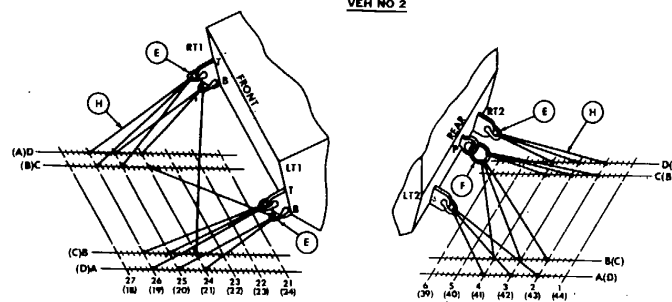

Figure 5-3. Rear view of M60 tank loaded and restrained on 140-ton DODX flatcar.

b. Two M60 tanks can be loaded onto the flatcar by being driven or lifted onto the car. Both tanks are generally positioned facing the same direction and secured as shown in figure 5-4. Also, both tanks must be centered over the centerline of the car so that the track overhang is about equal on both sides. Each tank will be positioned so that the center of the roadwheel nearest the end of the car is lined up with the yellow mark on the side of the flatcar, as shown in figure 5-4. The application of chain tiedowns for two M60 tanks facing the same direction is explained in table 5-3. If one or two M60 tanks are loaded facing the opposite direction from that shown in figures 5-1 and 5-4, the chain tiedowns for one tank will be applied as explained in table 5-4; or for two tanks, table 5-5.



VEH NO 2



VEH NO 1

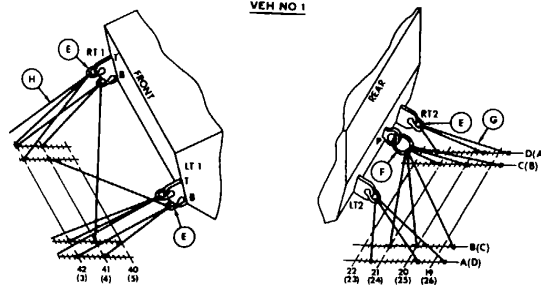

LEGEND

- RT1 RIGHT TIEDOWN (FRONT)
- LT1 LEFT TIEDOWN (FRONT)
- RT2 RIGHT TIEDOWN (REAR)
- LT2 LEFT TIEDOWN (REAR)
- P PINTLE
- T TOP
- B BOTTOM

Figure 5-4. Chain tiedown arrangement for two M60 tanks facing the same direction.

NOTE

Chain anchor locations are painted-along the four channels: white for M1 tank(s) and yellow for M60 tank(s). When viewed from the left side of the tank(s), the two left channels depict correct chain-anchor locations. The two right channels must be arranged in a mirror image of the two left channels to complete the four correct chain-anchor locations. After the chain anchors have been placed as prescribed above, the locations should be cross-checked with the applicable figures and tables to ensure accuracy.

5-4. Loading M728 Combat Engineer Vehicles

M728 combat engineer vehicles can be loaded onto the car either by being driven on or lifted onto with a crane or cranes of at least 60-ton capacity. One M728 combat engineer vehicle must be centered on the car according to the instructions for the M60 tank. Two M728 combat engineer vehicles must be loaded tail to tail.

a. A single M728 combat engineer vehicle must be positioned at the center of the flatcar in the same location as the single M60 tank shown in figure 5-1. The rear of this M728 vehicle must be tied down according to the same pattern as that used for the rear of an M60 tank. The front of the M728 vehicle must be tied down according to the pattern given in the following paragraph for securing one M728 and one M60 tank.

b. These vehicles must be lifted or driven onto the flatcar facing the same direction. The rear of the left idler wheel on the M728 must line up on the white mark at the M728 end of the car; the center of the rear roadwheel of the M60 must line up over the yellow mark at the M60 end of the car. The rear of the M728 vehicle must be secured with 12 chains, according to the same pattern as that used for the M60 tank rear tiedowns. The front of this M728 vehicle must be secured as shown in figure 5-5. The bill of materials required for one M728 vehicle and one M60 tank is provided in table 5-6, and the application of materials for these vehicles is explained in table 5-7. If one or both of the vehicles are loaded facing the opposite direction from that shown in figure 5-5, chain tiedowns will be applied as explained in table 5-8.

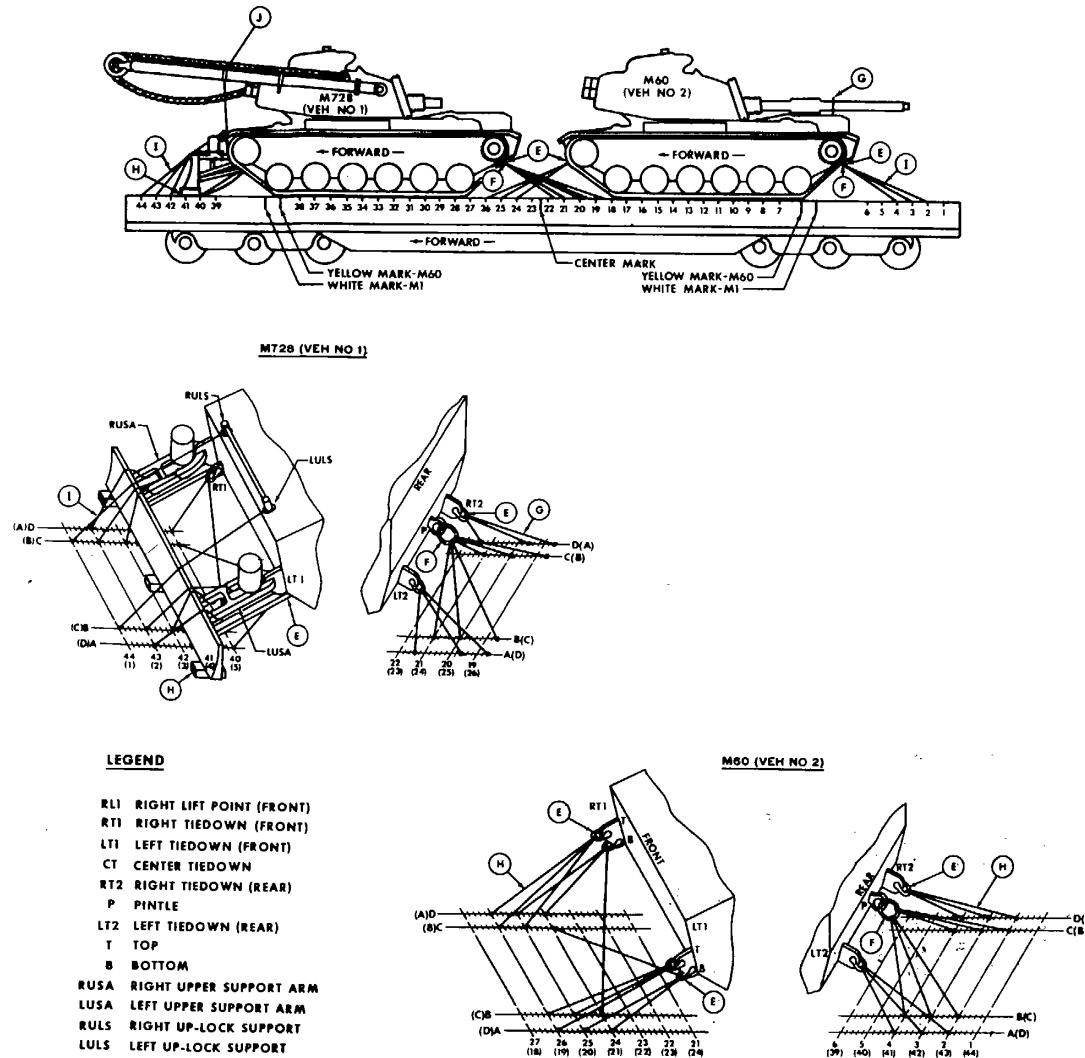

Figure 5-5. Chain tiedown arrangement for one M728 combat engineer vehicle and one M60 tank.

Table 5-1. Bill of Materials for Loading and Restraining One M60-Series Tank

Item	Description	Approximate Quantity (feet)
Wire Rope*	6 x 19 IWRC, improved plow steel, preformed, regular-lay; table X, Fed Spec RR-W-410: 3/8-inch	30
Clips*	Wire rope, U-bolt clips, saddled, single-rip, steel, Crosby heavy-duty or equal; MIL-STD-16842: 5/8 inch.	4
Clips*	Wire rope, U-bolt clips, saddled, single-grip, steel, Crosby heavy-duty or equal; MIL-STD-16842: 5/8- inch.	2
Shackles**	1 1/2 -inch-diameter wire size, 4-inch-diameter inside bow, 2 3/8-inch entrance to bow, 1 3/8 -inch thread pin, alloy steel heat-treated to 170,000 pounds minimum break strength; MacLean-Fogg (M-F) 61284, or equivalent.	6
Ring**	1 3/4-inch-diameter wire size, 7-inch-diameter inside, alloy steel heat-treated to 300,000 pounds minimum break strength, MacLean-Fogg (M-F) 61283, or Midland Forge MK0267.	1
Thimbles	Standard, open-type: 3/8-inch	2
Thimbles	Standard, open-type: 3/8 -inch	2

*Not required if gun tube is installed and tank has an operable external gun-tube brace.

**Furnished with flatcar.

Table 5-2. Application of Materials for Loading and Securing One M60-Series Tank (Fig 5-1)

Item	No. Required	Application
A thru D		Channels. For description, refer to paragraph 2-2c.
E	6	Shackles. At rear of tank, attach one shackle to each tiedown fitting. At front of tank, attach one shackle to each bottom and top tiedown fitting.
F	1	Ring. Attach to towing pintle at rear of tank.
G	1	Wire rope, 3/8-inch. Wrap gun tube with cushioning material. Place thimbles on the two rear lifting eyes and apply wire rope in two complete loops: one around gun tube to left-rear lifting eye, the other around gun tube to right-rear lifting eye. Pull loops hand tight and secure ends of each loop with two 3/8--inch U-bolt clips. Secure each thimble to wire rope with one 5/8-inch U-bolt clip. (Not required if tank has operable external gun-tube brace.)
H	24	Chains. Furnished with flatcar. Apply chains between tank tiedown fittings and anchor locations on the deck of the car, as described below. M60-SERIES TANK FACING POSITION NO. 44
RT1-B	3	Chains. Attach chains to the lower right-front tiedown shackle from chain anchors in B34, D34, and D35.
LT1-B	3	Chains. Attach chains to the lower left-front tiedown shackle from chain anchors in C34, A34, and A35.
RT1-T	3	Chains. Attach chains to the upper right-front tiedown shackle from chain anchors in D36, C35, and C36.
LT1-T	3	Chains. Attach chains to upper left-front tiedown shackle from chain anchors in A36, B35, and B36.
RT2	3	Chains. Attach chains to the right-rear tiedown shackle from chain anchors in D11, D10, and D9.
LT2	3	Chains. Attach chains to the left-rear tiedown shackle from chain anchors in A11, A10, and A9.
P	6	Chains. Attach chains to the ring in the pintle from chain anchors in C11, C10, C9, B11, B10, and B9.

GENERAL INSTRUCTIONS

1. M60-series tank brakes must be set. Transmission selector must be in park.
2. Turret gun must be in the aft travel position and secured to prevent movement. Turret rotation and gun-elevating controls must be wire-tied, if feasible, to prevent movement of turret and gun.
3. Turnbuckles of front and rear chain tiedowns must be tightened at the same time to avoid disturbing the tank position.
4. Also applicable are General Rules 4, 5, 7, 11, 15(g), 19, 19A, and 19C in Section 1 of the Rules Governing the Loading of Commodities on Open-Top Cars and Trailers, published by the Association of American Railroads. These general rules are also found in TM 55-2200-001-12.

Table 5-3. Application of Materials for Loading and Securing Two M\$O-Series Tanks (Fig 5-2)

Item	No. Required	Application
A thru D		Channels. For description, refer to paragraph 2-2c.
E	12	Shackle. At front of tank, attach one shackle to the top and bottom of each tiedow fitting. At rear of tank, attach one shackle to each tiedown fitting.
F	2	Rings. Attach to towing pintles at rear of tanks.
G	2	Wire rope, 3/8-inch. Wrap gun tube with cushioning material. Place the thimbles on the lifting eyes and apply wire rope in two complete loops: one around gun tube to left-rear lifting eye, the other around gun tube to right-rear lifting eye. Pull loops hand tight and secure ends of each loop with two 3/8-inch U-bolt clips. Secure each thimble to wire rope with one 5/8-inch U-bolt clip. (Not required if tank has operable external gun-tube brace.)
H	48	Chains. Furnished with flatcar. Apply chains between tank tiedown fittings and anchor locations on the deck of the car, as described below. M-60 SERIES TANK NO. 1 NEAR POSITION NO. 44
RT1-B	3	Chains. Attach chains to the lower right-front tiedown shackle from chain anchors in D41, D42, and B41.
RT1-T	3	Chains. Attach chains to the upper right-front tiedown shackle from chain anchors in C42, C43, and D43.
LT1-B	3	Chains. Attach chains to the lower left-front tiedown shackle from chain anchors in C41, A41, and A42.
LT1-T	3	Chains. Attach chains to the upper left-front tiedown shackle from chain anchors in B42, A43, and B43.
RT2	3	Chains. Attach chains to the right-rear tiedown shackle from chain anchors in D21-2/5, D19-3/5, and D18-3/5.
LT2	3	Chains. Attach chains to the left-rear tiedown shackle from chain anchors in A21-2/5, A19-3/5, and A18-3/5.
P	6	Chains. Attach chains to the ring in the pintle from chain anchors in B21, B20, B18-3/5, C21, C20, and C18-3/5. M60-SERIES TANK NO. 2 NEAR POSITION NO. 1
RT1-B	3	Chains. Attach chains to the lower right-front tie-down shackle from chain anchors in D24, D25, and B24.
LT1-B	3	Chains. Attach chains to the lower left-front tiedown shackle from chain anchors in A24, A25, and C24.
RT1-T	3	Chains. Attach chains to the upper right-front tiedown shackle from chain anchors in C25, C26, and D26.
LT1-T	3	Chains. Attach chains to the upper left-front tiedown shackle from chain anchors in B25, B26, and A26.
RT2	3	Chains. Attach chains to the right-rear tiedown shackle from chain anchors in D4, D3, and D2.
LT2	3	Chains. Attach chains to the left-rear tiedown shackle from chain anchors in A4, A3, and A2.
P	6	Chains. Attach chains to the ring in the pintle from chain anchors in C4, C3, C2, B4, B3, and B2.

GENERAL INSTRUCTIONS

1. M60-series tank brakes must be set. Transmission selector must be in park.
2. Turret gun must be in the aft travel position and secured to prevent movement. Turret rotation and gun-elevating controls must be wire-tied, if feasible, to prevent movement of turret and gun.
3. Turnbuckles of front and rear chain tiedowns must be tightened at the same time to avoid disturbing the tank position.
4. Also applicable are General Rules 4, 5, 7, 11, 15(g), 19, 19A, and 19C in Section 1 of the Rules Governing the Loading of Commodities on Open-Top Cars and Trailers, published by the Association of American Railroads. These general rules are also found in TM 55-2200-001-12.

Table 5-4. Application of Materials for Loading and Securing One M60-Series Tank Facing the Opposite Direction from that Shown in Figure 5-1

Item	No. Required	Application
A thru D		Channels. For description, refer to paragraph 2-2c.
E	6	Shackles. At rear of tank, attach one shackle to each tiedown fitting. At front of tank, attach one shackle to each bottom and top tiedown fitting.
F	1	Ring. Attach to towing pintle at rear of tank.

Table 5-4. Application of Materials for Loading and Securing One M60-Series Tank Facing the Opposite Direction from that Shown in Figure 5-1-Continued

Item	No. Required	Application
G	1	Wire rope, 3/8-inch. Wrap gun tube with cushioning material. Place thimbles on two rear lifting eyes and apply wire rope in two complete loops: one around gun tube to left-rear lifting eye, the other around gun tube to right-rear lifting eye. Pull loops hand tight and secure ends of each loop with 5/8-inch U-bolt clips. Secure each thimble to wire rope with one 3/8-inch U-bolt clip. (Not required if tank has operable external gun-tube brace.)
H	24	Chains. Furnished with flatcar. Apply chains between tank tiedown fitting and anchor locations on the deck of the car, as described below. M60-SERIES TANK FACING POSITION NO. 4
RT1-B	3	Chains. Attach chains to the lower right-front tiedown shackle from chain anchors in C11, All, and A10.
LT1-B	3	Chains. Attach chains to the lower left-front tiedown shackle from chain anchors in B11, D11, and D10.
RT1-T	3	Chains. Attach chains to the upper right-front tiedown shackle from chain anchors in A9, B10, and B9.
LT1-T	3	Chains. Attach chains to the upper left-front tiedown shackle from chain anchors in D9, C10, and C9.
RT2	3	Chains. Attach chains to the right-rear tiedown shackle from chain anchors in A34, A35, and A36.
LT2	3	Chains. Attach chains to the left-rear tiedown shackle from chain anchors in D34, D35, and D36.
P	6	Chains. Attach chains to the ring in the pintle from chain anchors in B34, B35, B36, C34, C35, and C36.

GENERAL INSTRUCTIONS

1. M60-series tank brakes must be set. Transmission selector must be in park.
2. Turret gun must be in the aft travel position and secured to prevent movement. Turret rotation and gun-elevating controls must be wire-tied, if feasible, to prevent movement of turret and gun.
3. Turnbuckles of front and rear chain tiedowns must be tightened at the same time to avoid disturbing the tank position.
4. Also applicable are General Rules 4, 5, 7, 11, 15(g), 19, 19A, and 19C in Section 1 of the Rules Governing the Loading of Commodities on Open-Top Cars and Trailers, published by the Association of American Railroads. These general rules are also found in TM 55-2200-001-12.

Table 5-5. Application of Materials for Securing Two M6-Series Tanks Facing the Opposite Direction from that Shown in Figure 5-2

Item	No. Required	Application
A thru D		Channels. For description, refer to paragraph 2-2c.
E	12	Shackle. At front of tank, attach one shackle to the top and bottom of each tiedown fitting. At rear of tank, attach one shackle to each tiedown fitting.
F	2	Rings. Attach to towing pintles of rear of tank.
G	2	Wire rope, 3/8-inch. Wrap gun tubes with cushioning material. Place thimbles on the two rear lifting eyes and apply wire ropes in two complete loops: one around gun tube to left-rear lifting eye, the other around gun tube to right-rear lifting eye. Pull loops hand tight and secure ends with two 3/8-inch U-bolt clips. Secure each thimble to wire rope with one 5/8-inch U-bolt clip. (Not required if tank has operable external gun-tube brace.)
H	48	Chains. Furnished with flatcar. Apply chains between tank tiedown fittings and anchor locations on the deck of the car, as described below. M60--SERIES TANK NO. 1 NEAR POSITION NO. 1
RT1-B	3	Chains. Attach chains to the lower right-front tiedown shackle from chain anchors in A4, A3, and C4.
RT1-T	3	Chains. Attach chains to the upper right-front tiedown shackle from chain anchors in A2, B3, and B2.
LT1-B	3	Chains. Attach chains to the lower left-front tiedown shackle from chain anchors in D4, D3, and B4.
LT1-T	3	Chains. Attach chains to the upper left-front tiedown shackle from chain anchors in D2, C3, and C2.
RT2	3	Chains. Attach chains to the right-rear tiedown shackle from chain anchors in A23-3/5, A25-2/5, and A26-2/5.
LT2	3	Chains. Attach chains to the left-rear tiedown shackle from chain anchors in D23- 3/5, D25-2/5, and D26-2/5.

Table 5-5. Application of Materials for Securing Two M60-Series Tanks Facing the Opposite Direction from that Shown in Figure 5-2 - Continued

Item	No. Required	Application
P	6	Chains. Attach to the ring in the pintle from chain anchors in B24, B25, B26-2/5, C24, C26, and C26-2/5.
M60-SERIES TANK NO. 2 NEAR POSITION NO. 44		
RT1-B	3	Chains. Attach chains to the lower right-front tiedown shackle from chain anchors in A21, A20, and C21.
LT1-B		Chains. Attach chains to the lower left-front tiedown shackle from chain anchors in D21, D20, and B21.
RT1-T	3	Chains. Attach chains to the upper right-front tiedown shackle from chain anchors in B20, B19, and A19.
LT1-T	3	Chains. Attach chains to the upper left-front tiedown shackle from chain anchors in C20, C19, and D19.
RT2	3	Chains. Attach chains to the right-rear tiedown shackle from chain anchors in A41, A42, and A43.
LT	3	Chains. Attach chains to the left-rear tiedown shackle from chain anchors in D41, D42, and D43.
P	6	Chains. Attach chains to the ring in the pintle from chain anchors in B41, B42, B43, C41, C42, and C43.

GENERAL INSTRUCTIONS

1. M60-series tank brakes must be set. Transmission selector must be in park.
2. Turret gun must be in the aft travel position and secured to prevent movement. Turret rotation and gun-elevating controls must be wire-tied, if feasible, to prevent movement of turret and gun.
3. Turnbuckles of front and rear chain tiedowns must be tightened at the same time to avoid disturbing the tank position.
4. Also applicable are General Rules 4, 5, 7, 11, 15(g), 19, 19A, and 19C in Section 1 of the Rules Governing the Loading of Commodities on Open-Top Cars and Trailers, published by the Association of American Railroads. These general rules are also found in TM 55-2200-001-12.

Table 5-6. Bill of Materials for Loading and Securing One M728 Combat Engineer Vehicle and One M60 Tank

Item	Description	Approximate Quantity (feet)
Lumber	Douglas-fir or comparable, straight-grain, free from material defects; Fed Spec MIL-L-751: 4- x 6-in.	4 lin ft
Wire Rope	6 x 19 IWRC, improved plow steel, preformed, regular-lay; table X, Fed Spec RR-W-410	90 ft
Clips	3/8-inch. Wire rope, U-bolt clips, saddled, single-grip, steel, Crosby heavy-duty, or equal; MIL-STD-16842: 3/8-inch.	8
Clips	Wire rope, U-bolt clips, saddled, single-grip, steel, Crosby heavy-duty, or equal; MIL-STD-16842: 5/8-inch.	4
Cushioning Material	Waterproof paper or suitable material	as required
Shackles*	1 1/2-inch-diameter wire size, 4-inch-diameter inside bow, 23/8-inch entrance to bow, 1-3/8-inch thread pin, alloy steel heat-treated to 170,000 pounds minimum break strength; MacLean-Fogg (M-F) 61284, or Midland Forge MK0267.	12
Ring*	1 3/4-inch-diameter wire size, 7-inch-diameter (inside), alloy steel heat-treated to 300,000 pounds minimum break strength, MacLean-Fogg (M-F) 61283, or equivalent.	2
Thimbles	Standard, open-type:3/8-in	4

*Furnished with flatcar.

Table 5-7. Application of Materials for Loading and Securing One M728 Combat Engineer Vehicle and One M Series Tank Fig 5-5

Item	No. Required	Application
A thru D	Channels.	For description, refer to paragraph 2-2c.
E	10	Shackles. At the rear of the M728 combat engineer vehicle, attach one shackle to each tiedown fitting. At the front of vehicle, attach one shackle to each bottom inside tiedown fitting. At the rear of the M60-series tank, attach one shackle to each tiedown fitting. At the front of the tank, attach one shackle to the top and bottom of each tiedown fitting.
F	2	Rings. Attach to towing pintles at rear of vehicles.

Table 5-7. Application of Materials for Loading and Securing One M728 Combat Engineer Vehicle and One M60-Series Tank Fig 5-5-Continued

Item	No. Required	Application
G	2	Wire rope, 3/8-inch. Wrap gun tube of M60-series tank with cushioning material. Place thimbles on two rear lifting eyes and apply wire rope in two complete loops: one around gun tube to left-rear lifting eye, the other around gun tube to right-rear lifting eye. Pull loops hand tight and secure ends with two 3/8s-inch clips. Secure each thimble to wire rope with one 5/8-inch U-bolt clip. (Not required if vehicle has operable external gun-tube brace.)
H	3	Lumber, 4X 6X 15-inch. Place one piece along centerline of flatcar and one piece 4 inches from each outside edge of the flatcar, where the M728 combat engineer vehicle blade will rest.
I	48	Chains. Furnished with flatcar. Apply chains between vehicle tiedown fittings and anchor locations on the deck of the car, as described below.
J	2	Wire rope, 3/8-inch. Wrap M728 boom with protective material. Apply wire rope in two complete loops, one around boom to left-front lifting eye, the other around boom to right-front lifting eye. Pull loops hand tight and secure ends of each loop with three 3/8-inch U-bolt clips.
K	as required	Cushioning material. Place cushioning material around tiedown chains at locations where chains might rub against the M728 bulldozer blade.
M728 COMBAT ENGINEER VEHICLE NO. 1		
RT1	2	Chains. Attach chains to right-front tiedown shackle from chain anchors in B40 and D40.
LT1	2	Chains. Attach chains to left-front tiedown shackle from chain anchors in C40 and A40.
RUSA	3	Chains. Attach two chains by looping chains around each top blade attachment point of RUSA from chain anchors in C42 and D43. Attach one chain by looping chain around RUSA, aft of structural crossmember, from chain anchor in C43.
RULS	1	Chain. Attach chain by looping around RULS from chain anchor in C44.
LUSA	3	Chains. Attach two chains by looping one chain around each top bulldozer-blade attachment point of LUSA from chain anchors in A43 and B42. Attach one chain by looping chain around LUSA, aft of structural cross-member, from chain anchor in B43.
LULS	1	Chain. Attach chains by looping chain around LULS from chain anchor in B44.
RT2	3	Chains. Attach chains to the right-rear tiedown shackle from chain anchors in D21-2/5, D19-3/5, and D18-3/5.
LT2	3	Chain. Attach chains to the left-rear tiedown shackle from chain anchors in A21-2/5, A19-3/5, and A18-3/5.
P	6	Chains. Attach chains to the ring in the pintle from chain anchors in B21, B20, B18-3/5, C21, C20, and C18-3/5.
M60 VEHICLE NO. 2		
RT1-B	3	Chains. Attach chains to the lower right-front tiedown shackle from chain anchors in D24, D25, and B24.
LT1-B	3	Chains. Attach chains to the lower left-front tiedown shackle from chain anchors in A24, A25, and C24.
RT1-T	3	Chains. Attach chains to the lower right-front tiedown shackle from chain anchors in C25, C26, and D26.
LT1-T	3	Chains. Attach chains to the upper left-hand tiedown shackle from chain anchors in B25, B26, and A26.
RT2	3	Chains. Attach chains to the right-rear tiedown shackle from chain anchors in D4, D3, and D2.
LT2	3	Chains. Attach chains to the left-rear tiedown shackle from chain anchors in A4, A3, and A2.
P	6	Chains. Attach chains to the ring in the pintle from chains anchors in C4, C3, C2, B4, B3, and B2.

GENERAL INSTRUCTIONS

1. Vehicle brakes must be set. Transmission selector must be in park.
2. Turret gun must be in the aft travel position and secured to prevent movement. Turret rotation and gun-elevating controls must be wire-tied, if feasible, to prevent movement of turret and gun.
3. Hook openings of chains around structural members of the bulldozer blade must face opposite the direction of pull of the tiedown chain.
4. Turnbuckles of front and rear chain tiedowns must be tightened at the same time to avoid disturbing the tank position.
5. Also applicable are General Rules 4, 5, 7, 11, 15(g), 19, 19A, and 19C in Section 1 of the Rules Governing the Loading of Commodities on Open-Top Cars and Trailers, published by the Association of American Railroads. These general rules are also found in TM 55-2200-001-12.

CAUTION

When looping chains around dozen blades, to prevent damage, avoid contact between the blade and turnbuckle, compression unit, or coupling link.

Table 5-8. Application of Materials for Loading and Securing One M728 Combat Engineer Vehicle and One M60-Series Tank Facing the Opposite Direction from that Shown in Figure 5-3

Item	No. Required	Application
A thru D		Channels. For description, refer to paragraph 2-2c.
E	10	Shackles. At the rear of the M728 combat engineer vehicle, attach one shackle to each tiedown fitting. At the front of the vehicle, attach one shackle to each bottom inside tiedown fitting. At the rear of the M60-series tank, attach one shackle to each tiedown fitting. At the front of the tank, attach one shackle to the top and bottom of each tiedown fitting.
F	2	Rings. Attach to towing pintles at rear of vehicles.
G	2	Wire ropes, 3/8-inch. Wrap gun tube of M60-series tank with cushioning material. Place thimbles on two rear lifting eyes and apply wire rope in two complete loops: one around gun tube to left-rear lifting eye, the other around gun tube to right-rear lifting eye. Pull loops hand tight and secure ends with two 3/8-inch U-bolt clips. Secure each thimble to wire rope with one 5/8-inch clip. (Not required if vehicle has operable external gun-tube brace.)
H	3	Lumber, 4x 6x 15-inch. Place one piece along centerline of flatcar and one piece 4 inches from each outside edge of the flatcar, where the M728 combat engineer vehicle blade will rest.
I	48	Chains. Furnished with flatcar. Apply chains between vehicle tiedown fittings and anchor locations on the deck of the flatcar, as described below.
J	2	Wire rope, 3/8-inch. Wrap M728 boom with protective material. Apply wire rope in two complete loops, one around boom to left-front lifting eye, the other around boom to right-front lifting eye. Pull loops hand tight and secure ends of each loop with three 3/8-inch U-bolt clips.
K	as required	Cushioning material. Place cushioning material around tiedown chains at locations where chains might rub against the M728 bulldozer blade.
M728 COMBAT ENGINEER VEHICLE		
RT1	2	Chains. Attach chains to right-front tiedown shackle from chain anchors in C5 and A 5.
LT1	2	Chains. Attach chains to left-front tiedown shackle from chain anchors in B5 and D5.
RUSA	3	Chains. Attach two chains by looping chains around each top blade attachment point of RUSA from chain anchors in B3 and A2. Attach one chain by looping chain around RUSA, aft of structural crossmember, from chain anchor in B2.
RULS	1	Chain. Attach chain by looping chain around RULS from chain anchor in B1.
LUSA	3	Chains. Attach two chains by looping one chain around each top bulldozer-blade attachment point of LUSA from chain anchors in D2 and C3. Attach one chain by looping chain around LUSA, aft of structural cross-member, from chain anchor in B43.
LULS	1	Chain. Attach chain by looping chain around LULS from chain anchor in C1.
RT2	3	Chains. Attach chains to the right-rear tiedown shackle from chain anchors in A23-3/5, A25-2/5, and A26-2/5.
LT2	3	Chains. Attach chains to the left-rear tiedown shackle from chain anchors in D23-3/5, D25-2/5, and D26-2/5.
P	6	Chains. Attach chains to the ring in the pintle from chain anchors in B24, B25, B262/5, C24, C25, and C26-2/5.
M60 TANK		
RT1-B	3	Chains. Attach chains to the lower right-front tiedown shackle from chain anchors in A21, A20, and C21.
LT1-B	3	Chains. Attach chains to the lower left-front tiedown shackle from chain anchors in D21, D20, and B21.
RT1-T	3	Chains. Attach chains to the upper right-front tiedown shackle from chain anchors in B20, B19, and A19.
LT1-T	3	Chains. Attach chains to upper left-front tiedown shackle from chain anchors in C20, C19, and D19.
RT2	3	Chains. Attach chains to the right-rear tiedown shackle from chain anchors in A41, A42, and A43.
LT2	3	Chains. Attach chains to the left-rear tiedown shackle from chain anchors in D41, D42, and D43.
P	6	Chains. Attach chains to the ring in the pintle from chain anchors in B41, B42, B43, C41, C42, and C43.

GENERAL INSTRUCTIONS

1. Vehicle brakes must be set. Transmission selector must be in park.
2. Turret gun must be in the aft travel position and secured to prevent movement. Turret rotation and gun-elevating controls must be wire-tied, if feasible, to prevent movement of turret and gun.
3. Hook openings of chains around structural members of the bulldozer blade must face opposite the direction of pull of the tiedown chain.
4. Turnbuckles of front and rear chain tiedowns must be tightened at the same time to avoid disturbing the tank position.
5. Also applicable are General Rules 4, 5, 7, 11, 15(g), 19, 19A, and 19C in Section 1 of the Rules Governing the Loading of Commodities on Open-Top Cars and "Trailers, published by the Association of American Railroads. These general rules are also found in TM 55-2200-001-12.

CHAPTER 6

TRANSPORT OF ONE OR TWO M88 RECOVERY VEHICLES

6-1. Scope

This chapter provides guidance for transport of one or two M88 recovery vehicles on the 140-ton flatcar and prescribes the loading and tiedown procedures.

6-2. General

The M88 recovery vehicle with the machine-gun removed is 135 inches (3.43 m) wide and 117.2 inches (2.98 m) high. When the vehicle is loaded on the flatcar, its tracks extend about 6 inches (0.15 m) beyond each side of the car. The M88 recovery vehicle can be transported on the flatcar without major disassembly, but will require special routing by the railroads because its width exceeds the 128inch limit for unrestricted movement.

6-3. Loading M88 Recovery Vehicles

a. A single M88 recovery vehicle can be loaded onto the flatcar either by being driven onto the car over an end-loading ramp or by being lifted onto the car with a crane or cranes of at least 55ton capacity. The vehicle must be centered on the car with about equal overhang of its tracks on both sides of the car. A difference of 1 inch between the left-side and right-side overhang is the maximum permitted by many railroad load inspectors. The vehicle must be positioned so that the white mark at the center of the flatcar side is centered between the third and fourth roadwheels. The chain tiedown arrangement for a single M88 recovery vehicle is shown in figure 6-1. The bill of materials required to secure one M88 recovery vehicle on the flatcar is provided in table 6-1. The application of materials and chain tiedowns for a single M88 recovery vehicle is explained in table 6-2.

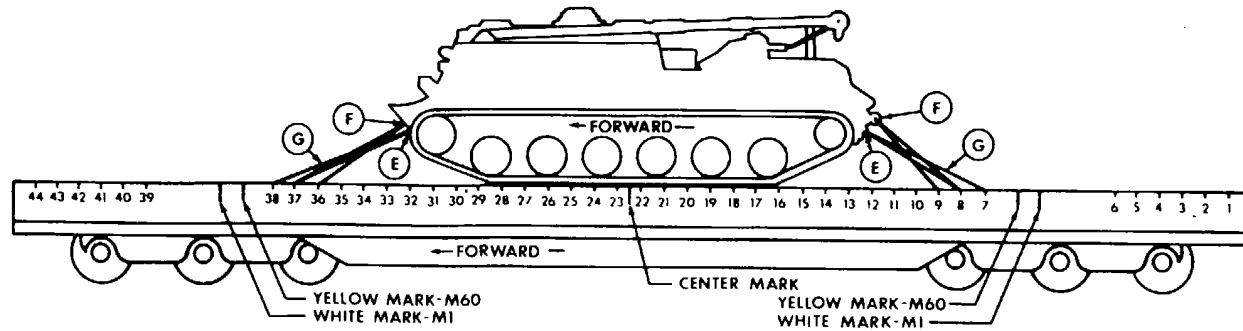

LEGEND

- RT1 RIGHT TIEDOWN (FRONT)
- LT1 LEFT TIEDOWN (FRONT)
- RT2 RIGHT TIEDOWN (REAR)
- LT2 LEFT TIEDOWN (REAR)
- P PINTLE
- CT CENTER TIEDOWN

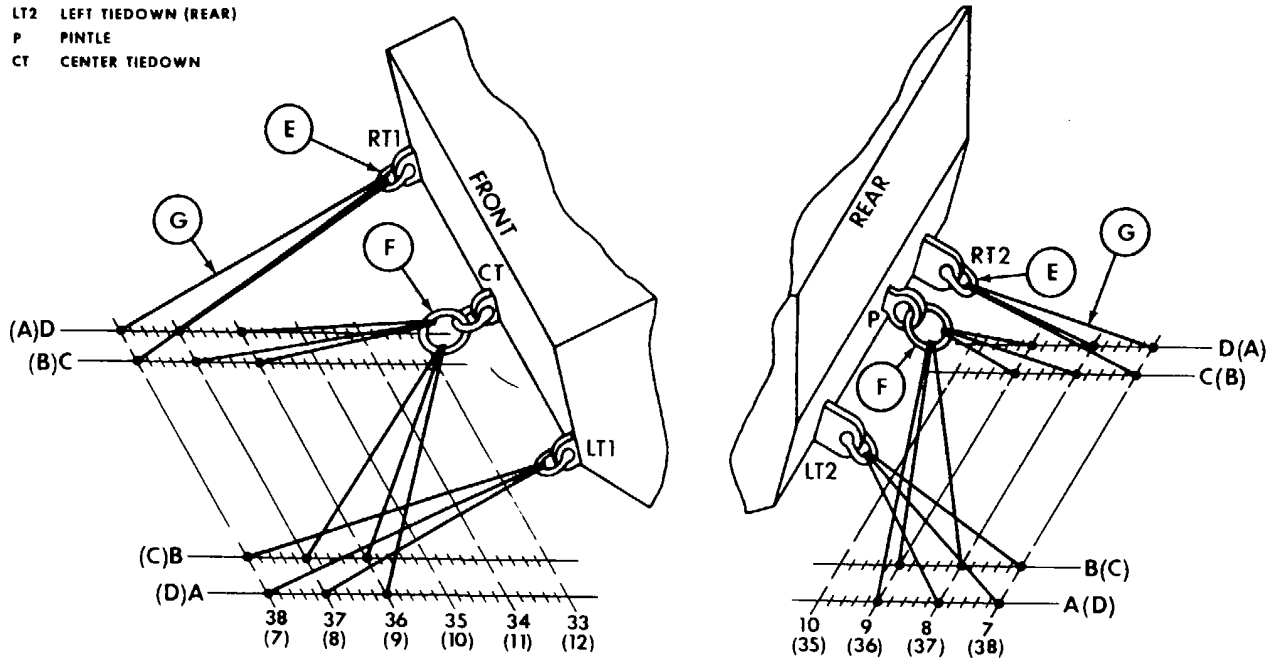
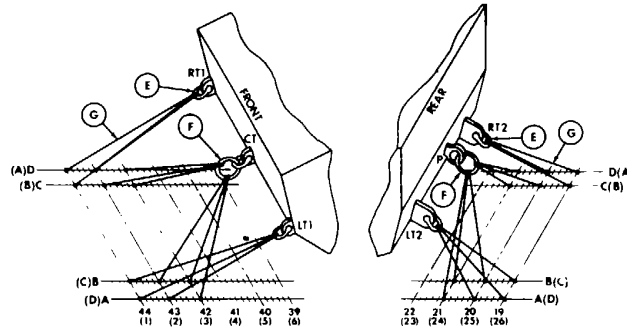
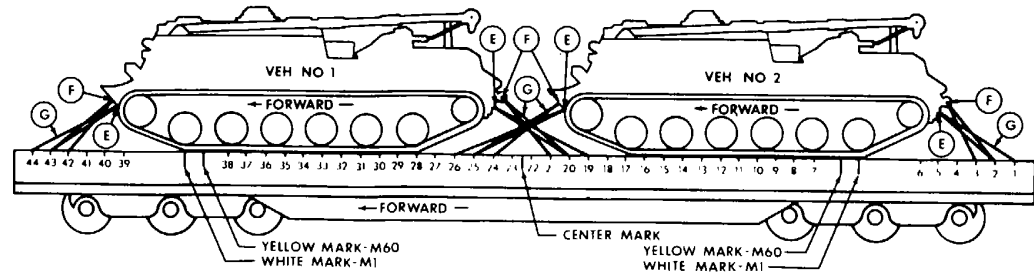

Figure 6-1. Chain tiedown arrangement for one M88 recovery vehicle.

b. Two M88 recovery vehicles can be loaded onto the flatcar by being driven or lifted onto the car.

Both vehicles must be centered over the centerline of the car so that the track overhang is about equal on both sides. Both vehicles must be facing the same direction and secured as shown in figure 6-2. Each vehicle must be positioned so that the center of the roadwheel nearest the end of the car is lined up with the white mark on the side of the car. The application of chain tiedowns for two M88 recovery vehicles is explained in table 6-3. Front, rear, and between vehicles chain arrangements are shown in figures 6-3 through 6-5, respectively.

If one or two M88 recovery vehicles are loaded facing the opposite direction from that shown in figures 6-1 and 6-2, the chain tiedowns for one M88 recovery vehicle will be applied as explained in table 6-4; or for two vehicles, table 6-5.



LEGEND

- RT1 RIGHT TIEDOWN (FRONT)
- LT1 LEFT TIEDOWN (FRONT)
- RT2 RIGHT TIEDOWN (REAR)
- LT2 LEFT TIEDOWN (REAR)
- P PINTLE
- CT CENTER TIEDOWN

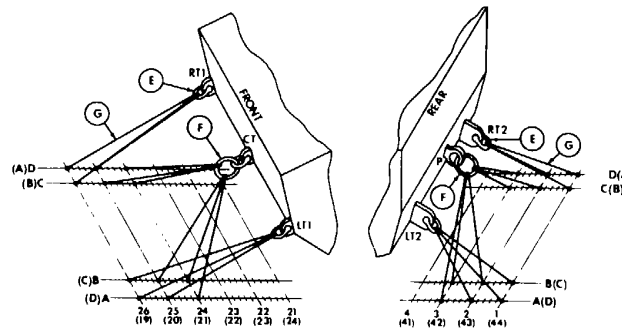

Figure 6-2. Chain tiedown arrangement for two M88 recovery vehicles.

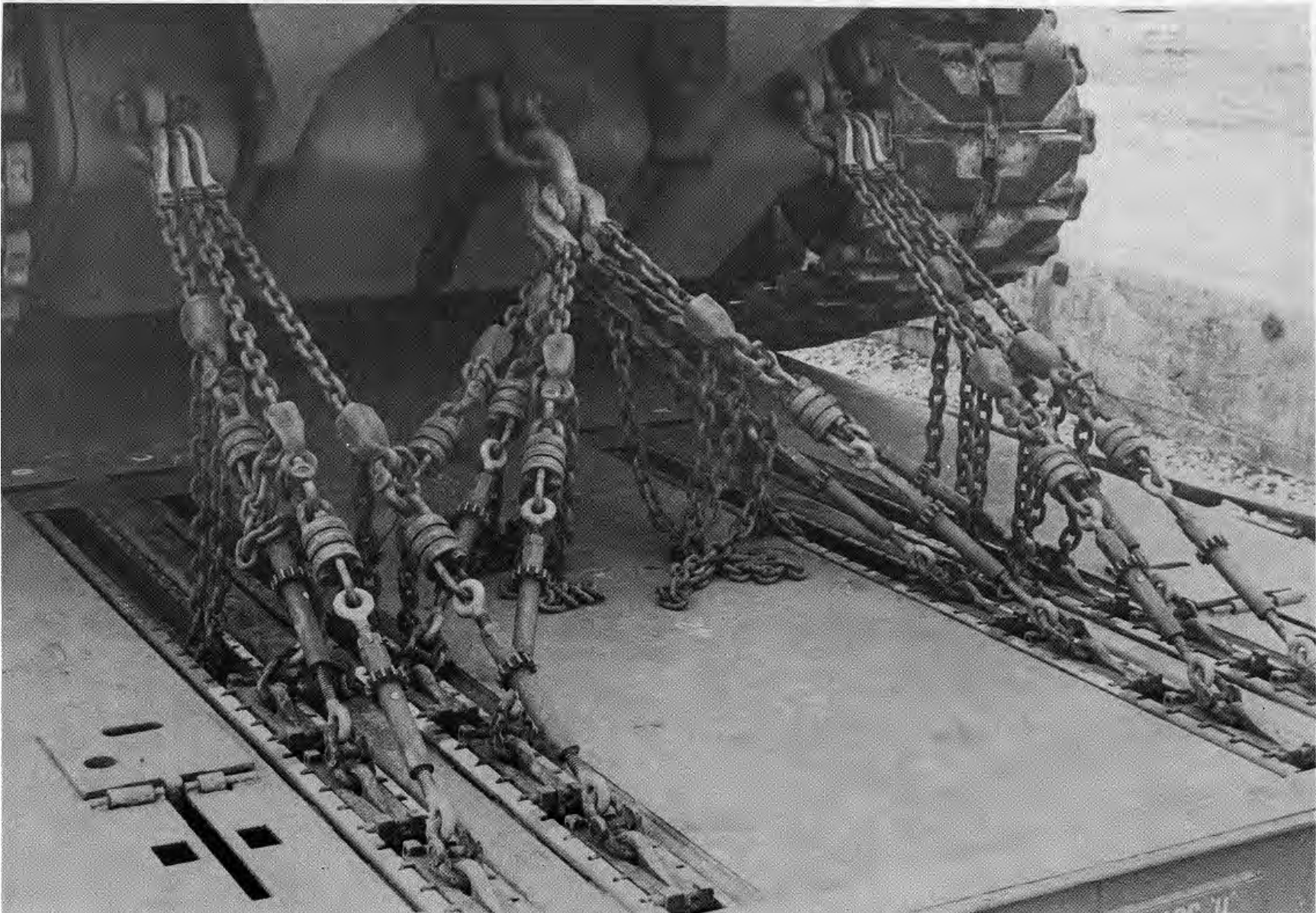

Figure 6-3. Front view of M88 recovery vehicle loaded and restrained on 140-ton DODX flatcar.

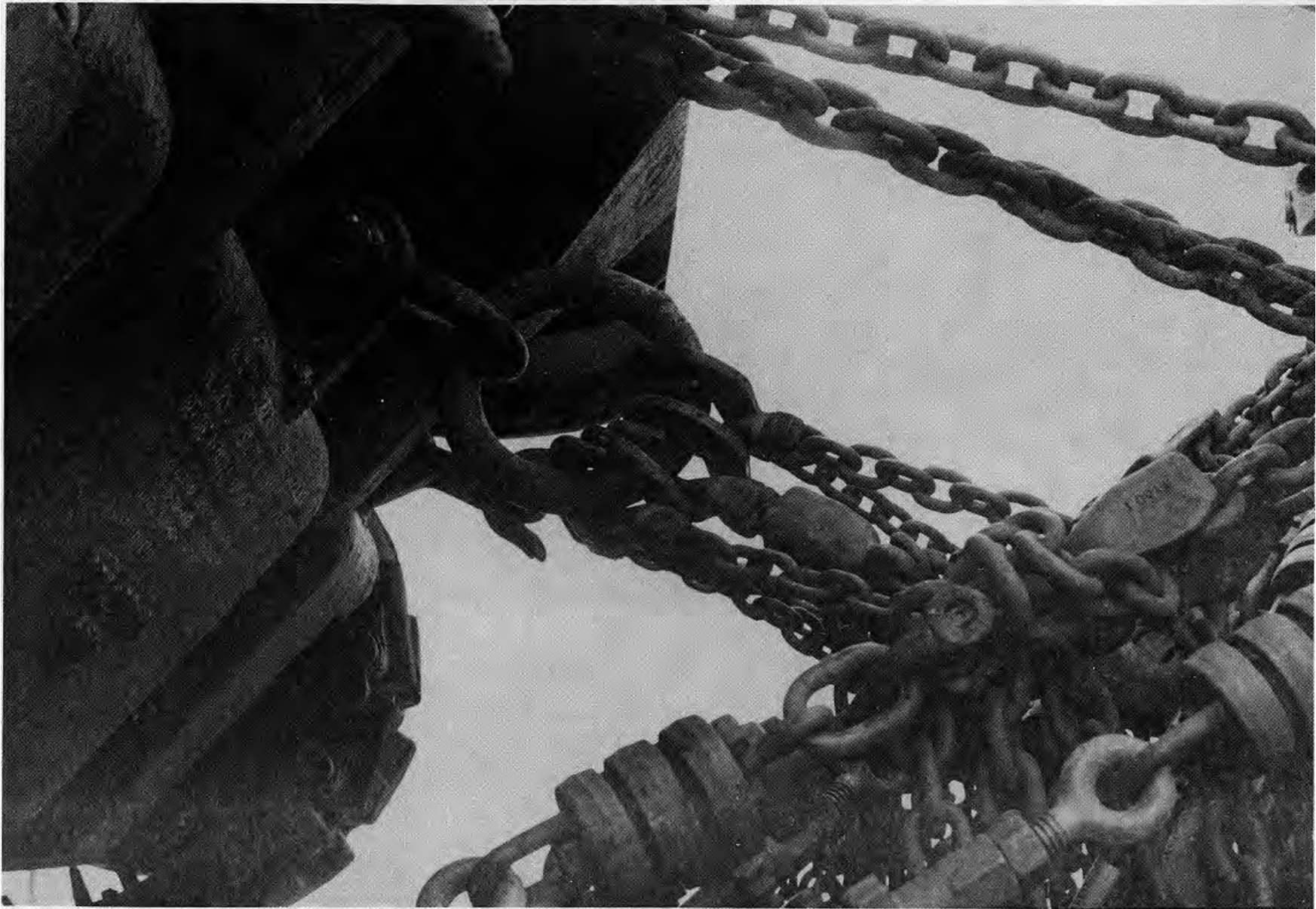

Figure 6-4. Closeup of alternating hook placement on center-front ring of M88.

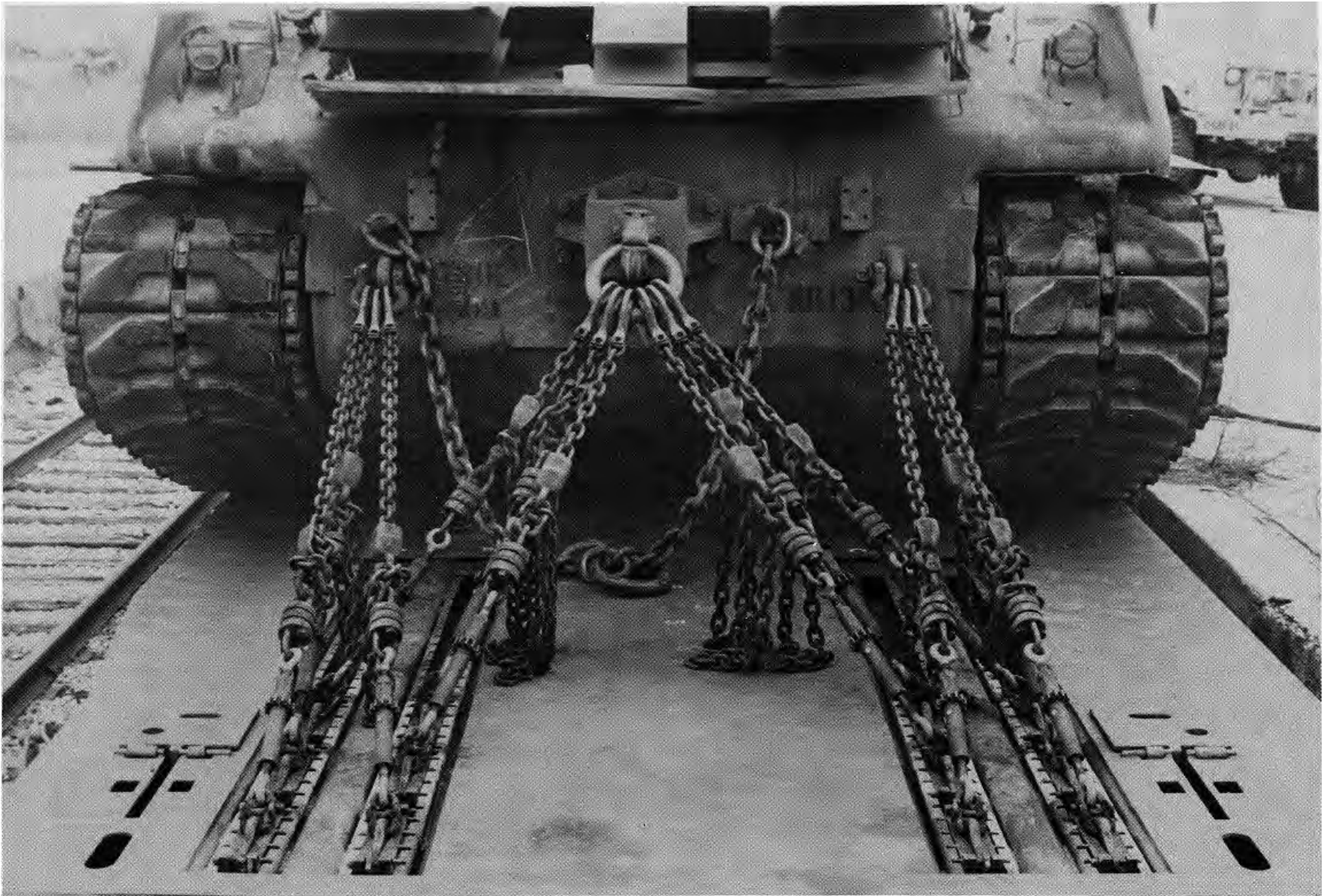

Figure 6-5. Rear view of M88 recovery vehicle loaded and restrained on 140-ton DODX flatcar.

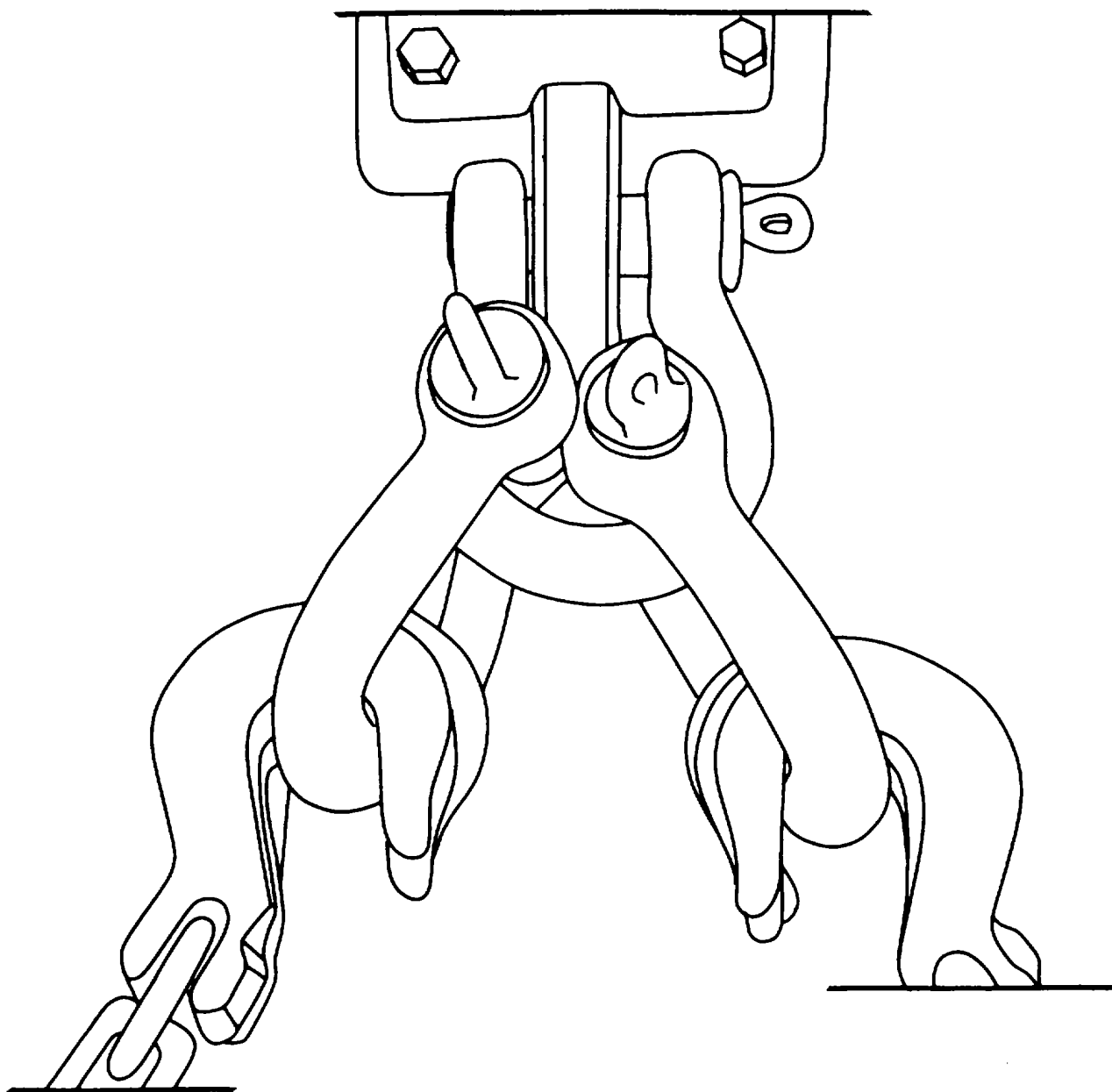

Figure 6-6. Three-shackle arrangement for center-front tiedown of M88.

Table 6-1. Bill of Materials for Loading and Securing One M88 Recovery Vehicle

Item	Description	Approximate Quantity (feet)
Shackles*	1 1/2-inch-diameter wire size, 4-inch-diameter inside bow, 2%-inch entrance to bow, 13/8-inch threadpin, alloy steel heat-treated to 170,000 pounds minimum break strength; MacLean-Fogg (M-F) 61284, or Midland Forge MK0267	5/7**
Ring'	13/4-inch-diameter wire size, 7-inch-diameter (inside), alloy steel heat-treated to 300,000 pounds minimum break strength, MacLean-Fogg (M-F) 61283, or equivalent	2/1**

*Furnished with flatcar.

**Two additional shackles may be substituted for the ring at the center-front tow lug (see fig 6-6).

Table 6-2. Application of Materials for Securing One M88 Recovery Vehicle (Fig 6-1)

Item	No. Required	Application
A thru D	ixl	Channels. For description, refer to paragraph 2-2c.
E	/7	Shackles. Attach one shackle to each tow lug (three in front and two on rear of each vehicle).
F	2/1	Rings. Hang one ring in towing pintle, and latch pintle closed; attach other ring/shackle to center-front tow lug. (Use shackle to attach ring/shackles to center tow lug.)
G	24	Chains. Furnished with flatcar. Apply chains between vehicle tiedown fittings and anchor locations on the deck of the car, as described below.
RT2	3	Chains. Attach chains to the right-rear tiedown fitting shackle from chain anchors in D7, D8, and C7.
LT2	3	Chains. Attach chains to the left-rear tiedown fitting shackle from chain anchors in A7, AS, and B7.
P	6	Chains. Attach chains to the ring in the pintle from chain anchors in D9, C9, C8, B9, B8, and A9.
RT1	3	Chains. Attach chains to the right-front tiedown fitting shackle from chain anchors in D38, D37, and C38.
LT1	3	Chains. Attach chains to the left-front tiedown fitting shackle from chain anchors in A38, A37, and B38.
CT	6	Chains. Attach chains to the ring/shackles in the center-front tiedown fitting shackle from chain anchors in A36, B36, B37, C36, C37, and D36. Alternate hook placement for ring right-left, and so forth. See figures 6-3 and 6-4. For shackle arrangement, see fig 6-6.

GENERAL INSTRUCTIONS

1. M60-series tank brakes must be set. Transmission selector must be in park.
2. Turret gun must be in the aft travel position and secured to prevent movement. Turret rotation and gun-elevating controls must be wire-tied, if feasible, to prevent movement of turret and gun.
3. Turnbuckles of front and rear chain tiedowns must be tightened at the same time to avoid disturbing the tank position.
4. Also applicable are General Rules 4, 5, 7, 11, 15(g), 19, 19A, and 19C in Section 1 of the Rules Governing the Loading of Commodities on Open-Top Cars and Trailers, published by the Association of American Railroads. These general rules are also found in TM 55-2200-001-12.

Table 6-3. Application of Materials for Securing Two M88 Recovery Vehicles (Fig 6-2)

Item	No. Required	Application
A thru D		Channels. For description, refer to paragraph 2-2c.
E	5/7 per veh	Shackles, anchor. Attach one shackle to each tow lug (three on front and two on rear of each vehicle.)
F	2/1 per veh	Rings. Hang one ring in towing pintle, and latch pintle closed; attach other ring/shackles to front tow lug. (Use shackle to attach ring/shackles to center tow lug.)
G	24 per veh	Chains. Furnished with flatcar. Apply chains between vehicle tiedown fittings and anchor locations on the deck of the car, as described below.
M88 VEHICLE TANK NEAR POSITION NO. 44		
RT2	3	Chains. Attach chains to the right-rear tiedown fitting shackle from chain anchors in D20, D19, and C19.
LT2	3	Chains. Attach chains to the left-rear tiedown fitting shackle from chain anchors in A20, A19, and B19.
P	6	Chains. Attach chains to the ring in the pintle from chain anchors in D21, C21, B21, A21, C20, and B20.

Table 6-3. Application of Materials for Securing Two M88 Recovery Vehicles (Fig 6-2)-Continued

Item	No. Required	Application
RT1	3	Chains. Attach chains to the right-front tiedown fitting shackle from chain anchors in D44, D43, and C44.
LT1	3	Chains. Attach chains to the left-front tiedown fitting shackle from chain anchors in A44, A43, and B44.
CT	6	Chains. Attach chains to the ring/shackles in the center-front tiedown fitting shackle from chain anchors in A42, B42, C42, D42, B43, and C43. Alternate hook placement for ring right-left, and so forth. See figures 6-3 and 6-4. For shackle arrangement, see figure 6-6. M88 VEHICLE NEAR POSITION NO. 1
RT2	3	Chains. Attach chains to the right-rear tiedown fitting shackle from chain anchors in D2, D1, and C1.
LT2	3	Chains. Attach chains to the left-rear tiedown fitting shackle from chain anchors in A1, B1, and A2.
P	6	Chains. Attach chains to the ring in the pintle from chain anchors in D3, C3, C2, B3, B2, and AS.
RT1	3	Chains. Attach chains to the right-front tiedown fitting shackle from chain anchors in D26, D25, and C26.
LT1	3	Chains. Attach chains to the left-front tiedown fitting shackle from chain anchors in A26, A25, and B26.
CT	6	Chains. Attach chains to the ring in the center-front tiedown fitting shackle from chain anchors in A24, B24, B25, C25, C24, and D24. Alternate hook placement for ring right-left, and so forth. See figures 6-3 and 6-4.

GENERAL INSTRUCTIONS

1. M60-series tank brakes must be set. Transmission selector must be in park.
2. Turret gun must be in the aft travel position and secured to prevent movement. Turret rotation and gun-elevating controls must be wire-tied, if feasible, to prevent movement of turret and gun.
3. Turnbuckles of front and rear chain tiedowns must be tightened at the same time to avoid disturbing the tank position.
4. Also applicable are General Rules 4, 5, 7, 11, 15(g), 19, 19A, and 19C in Section 1 of the Rules Governing the Loading of Commodities on Open-Top Cars and Trailers, published by the Association of American Railroads. These general rules are also found in TM 55-2200-001-12.

Table 6-4. Application of Materials for Securing One M88 Recovery Vehicle Facing the Opposite Direction from that Shown in Figure 6-1. (For location of "item," refer to figure 6-1.)

Item	No. Required	Application
A thru D		Channels. For description, refer to paragraph 2-2c.
E	5/7	Shackles. Attach one shackle to each tow lug (three on front and two on rear of vehicle).
F	2/1	Rings. Hang one ring in towing pintle, and latch pintle closed; attach other ring/shackles to front-center tow lug. (Use shackle to attach ring/shackles to tow lug.)
G	24	Chains. Furnished with flatcar. Apply chains between vehicle tiedown fittings and anchor locations on the deck of the car, as shown in figure 6-1 and described below.
RT2	3	Chains. Attach chains to the right-rear tiedown fitting shackle from chain anchors in A38, A37, and B38.
LT2	3	Chains. Attach chains to the left-rear tiedown fitting shackle from chain anchors in D38, D37, and C88.
P	6	Chains. Attach chains to the ring in the pintle from chain anchors in A36, B36, B37, C36, C37, and D36.
RT1	3	Chains. Attach chains to the right-front tiedown fitting shackle from chain anchors in A7, A8, and B7.
LT1	3	Chains. Attach chains to the left-front tiedown fitting shackle from chain anchors in D7, DS, and C7.
CT	6	Chains. Attach chains to the ring in the center-front tiedown fitting shackle from chain anchors in A9, B9, BS, D9, CS, and C9. Alternate hook placement right-left for ring and so forth. See figures 6-8 and 6-4. For shackle arrangement, see figure 6-6.

GENERAL INSTRUCTIONS

1. M60-series tank brakes must be set. Transmission selector must be in park.
2. Turret gun must be in the aft travel position and secured to prevent movement. Turret rotation and gun-elevating controls must be wire-tied, if feasible, to prevent movement of turret and gun.
3. Turnbuckles of front and rear chain tiedowns must be tightened at the same time to avoid disturbing the tank position.
4. Also applicable are General Rules 4, 5, 7, 11, 15(g), 19, 19A, and 19C in Section 1 of the Rules Governing the Loading of Commodities on Open-Top Cars and Trailers, published by the Association of American Railroads. These general rules are also found in TM 55-2200-001-12.

Table 6-5. Application of Materials for Securing Two M88 Recovery Vehicles Facing the Opposite Direction from that Shown in Figure 6-2 (For Location of "items," refer to fig 6-2)

Item	No. Required	Application
A thru D		Channels. For description, refer to paragraph 2-2c.
E	5/7 per veh	Shackles. Attach one shackle to each tow lug (three on front and two on rear of each vehicle). Tiedown eyes welded to hull behind idler wheels need no shackles.
F	2/2 per veh	Rings. Hang one ring in towing pintle, and latch pintle closed; attach other ring/shackles to front-center tow lug. (Use shackle to attach ring/shackles to center tow lug.)
G	24 per veh	Chains. Furnished with flatcar. Apply chains between vehicle tiedown fittings and anchor locations on the deck of the car, as described below.
M88 VEHICLE NO. 1		
RT2	3	Chains. Attach chains to the right-rear tiedown fitting shackle from chain anchors in A25, A26, and B26.
LT2	3	Chains. Attach chains to the left-rear tiedown fitting shackle from chain anchors in D25, D26, and C26.
P	6	Chains. Attach chains to the ring in the pintle from chain anchors in A24, B24, C24, D24, B25, and C25.
RT1	S	Chains. Attach chains to the right-front tiedown fitting shackle from chain anchors in A1, A2, and B1.
LT1	3	Chains. Attach chains to the left-front tiedown fitting shackle from chain anchors in D1, D2, and C1.
CT	6	Chains. Attach chains to the ring/shackles in the center-front tiedown fitting shackle from chain anchors in D3, C3, B3, AS, C2, and B2. Alternate hook placement right-left for ring and so forth. See figures 6-3 and 6-4. For shackle arrangement see figure 6-6.
M88 VEHICLE NO. 2		
RT2	8	Chains. Attach chains to the right-rear tiedown fitting shackle from chain anchors in A43, A44, and B44.
LT2	3	Chains. Attach chains to the left-rear tiedown fitting shackle from chain anchors in D44, C44, and D43.
P	6	Chains. Attach chains to the ring in the pintle from chain anchors in A42, B42, B43, C42, C43, and D42.
RT1	3	Chains. Attach chains to the right-front tiedown fitting shackle from chain anchors in A19, A20, and B19.
LT1	3	Chains. Attach chains to the left-front tiedown fitting shackle from chain anchors in D19, D20, and C19.
CT	6	Chains. Attach chains to the ring/shackles in the center-front tiedown fitting shackle from chain anchors in D21, A21, C20, B20, B21, and C21. Alternate hook placement for ring right-left and so forth. See figures 6-3 and 6-4. For shackle arrangement, see figure 6-6.

CHAPTER 7

TRANSPORT OF ONE OR TWO M109-SERIES SELF-PROPELLED HOWITZERS

7-1. Scope

This chapter provides guidance for transport of one or two M109-series self-propelled howitzers on the 140-ton flatcar and prescribes the loading and tiedown procedures. The tiedown and lift provisions for the M109, M109A1, and M109A2 are the same. For purpose of illustration, the M109A1 is shown in this manual.

7-2. General

The M109-series howitzers are full-tracked vehicles. They are 128 inches (3.25 m) wide and 114 inches (2.90 m) high with the machinegun removed. The M109 weighs 44,437 pounds (20157 kg), the M109A1 weighs 49,048 pounds (22248 kg), and the M109A2 weighs 47,960 pounds (21755 kg).

When the howitzer is loaded on the flatcar, its tracks extend about one-half inch beyond each side of the car. The M109-series howitzers can be transported without major disassembly.

7-3. Loading M109-Series Self-Propelled Howitzers**NOTE**

Throughout the remainder of this chapter, the M109-series self-propelled howitzers will be referred to as "the M109" or "the howitzer." Instructions and procedures apply to the M109, M109A1, and M109A2.

a. A single M109 can be loaded onto the flatcar either by being driven onto the car over an endloading ramp or by being lifted onto the car with a crane or cranes of at least 25-ton capacity. The M109 must be centered on the car, with about equal overhang of its tracks on both sides of the car. The M109 must be positioned so that the white mark at the center of the flatcar side is lined up with the center of the hub of the fourth roadwheel of the M109. The chain tiedown arrangement for a single M109 is shown in figure 71. The bill of materials required to secure one M109 on the flatcar is provided in table 7-1. The application of materials and chain tiedowns for a single M109 is explained in table 7-2.

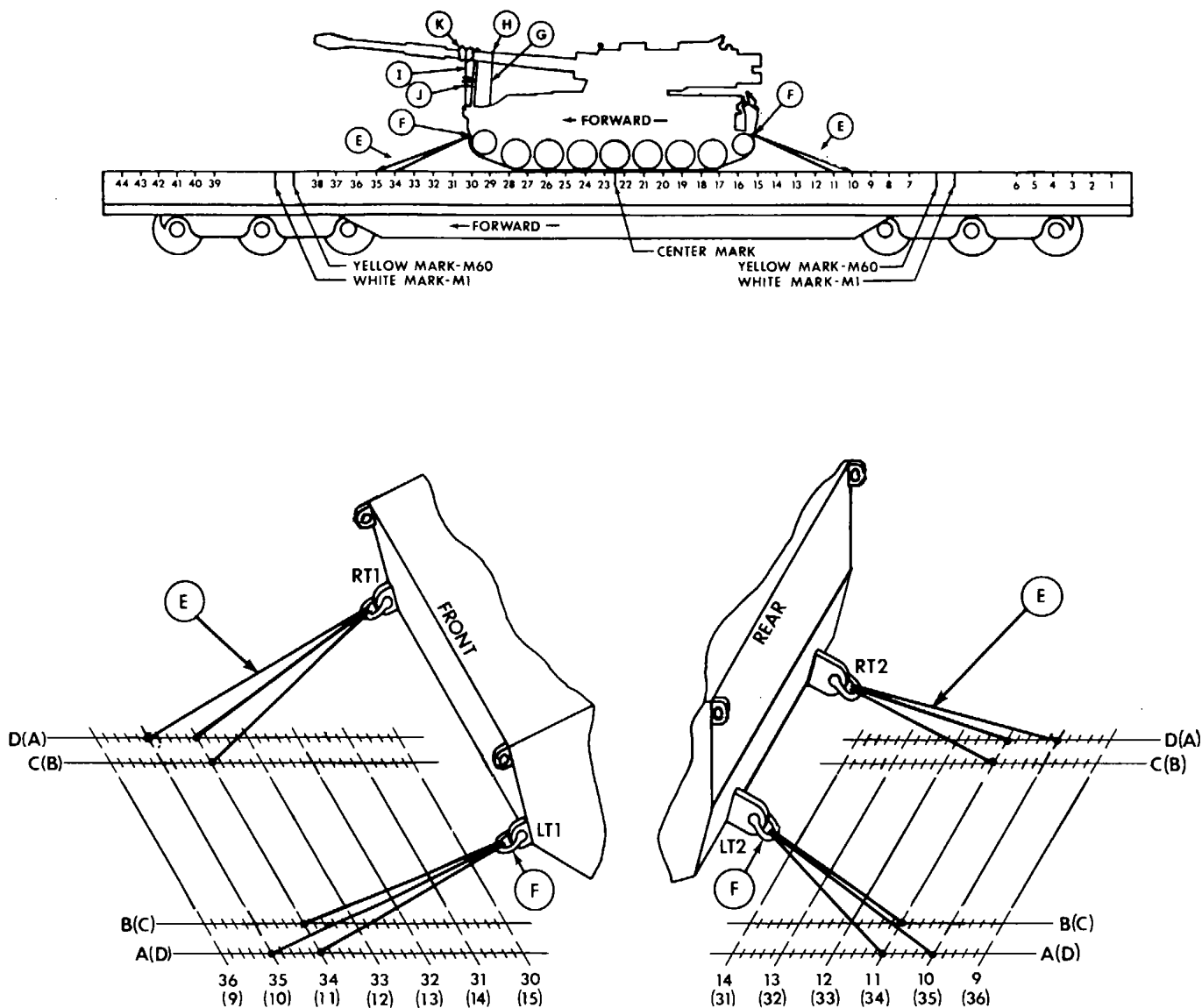

Figure 7-1. Chain tiedown arrangement for one MO19 self-propelled howitzer.

b. Two M109 howitzers can be loaded onto the flatcar by being driven or lifted onto the car. Both howitzers must be centered over the centerline of the car so that the track overhang is about equal on both sides. Both howitzers must be facing the same direction and secured as shown in figure 7-2. The front of the M109 must be positioned so that the center of the front roadwheel is lined up with the yellow mark nearest position No. 44. The other M109 must be positioned so that the center of the TM 55-2220-058-14 rear roadwheel is lined up with the yellow mark at the other end of the car. The application of materials and chain tiedowns for two M109 howitzers is explained in table 7-3. If one or two M109 howitzers are loaded facing the opposite direction from that shown in figures 7-1 and 7-2, the chain tiedowns for one M109 howitzer will be applied as explained in table 7-4; or, for two howitzers, table 7-5.

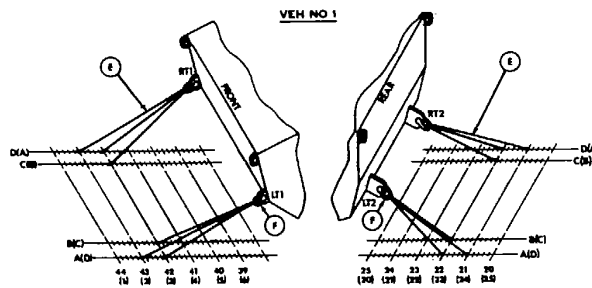
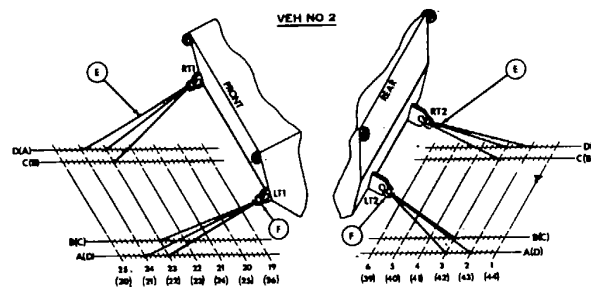
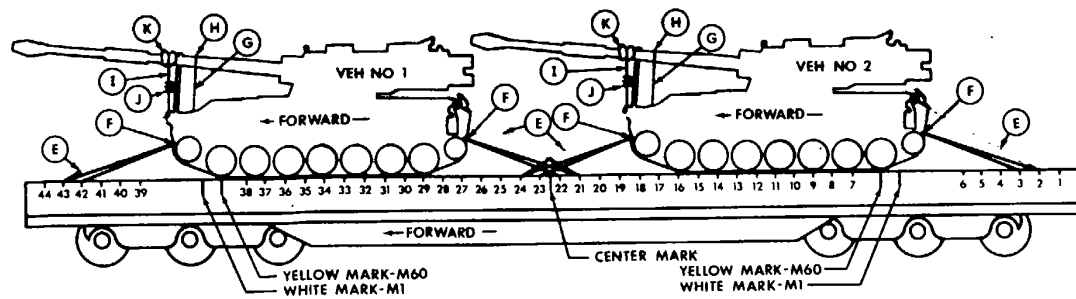

Figure 7-2. Chain tiedown arrangement for two MA109 howitzers.

Table 7-1. Bill of Materials for Loading and Securing One M109 Self-Propelled Howitzer

Item	Description	Approximate Quantity
Lumber*	Douglas-fir or comparable, straight-grain, free from material defects; Fed Spec MIL-L 751: 2- x 6-inch	2 1 in ft
Wire rope*	6 x 19 IWRC, improved plow steel, preformed, regular-lay; table X, Fed Spec RR-W-410: 3/8-inch	30 ft
Clips*	Wire rope, U-bolt clips, saddled, single-grip, steel, Crosby heavy-duty, or equal; MIL-STD-16842: 3/8-inch	4
Clips*	Wire rope, U-bolt clips, saddled, single-grip, steel, Crosby heavy-duty, or equal; MIL-STD-16842: 5/8-inch	2
Strapping*	Steel, high tension; Fed Spec QQ-781H, type I or IV, 3/4- x .035-inch	3 ft
Nails*	Common, steel, flathead; bright or cement-coated; table XI-b, Fed Spec FF-N-105A: 6d	4
Padding*	Protective rubber, waterproof paper, burlap, or other suitable material that will prevent wire rope from damaging gun barrel	as required
Shackles**	1 1/2-inch-diameter wire size, 4-inch-diameter inside bow, 2 3/8-inch entrance to bow, 13/8-inch thread pin, alloy steel heat-treated to 170,000 pounds minimum break strength; MacLean-Fogg (M-F) 61284, or Midland Forge MK0267	4
Thimbles	Standard, open-type: 3/8-inch	2

* Not required if howitzer has an operable external gun-tube brace.

** Furnished with flatcar.

Table 7-2. Application of Materials for Securing One M109 Self-Propelled Howitzer (Fig 7-1)

Item	No. Required	Application
A thru D		Channels. For description, refer to paragraph 2-2c.
E	12	Chains. Furnished with flatcar. Apply chains between M109 tiedown fitting and anchor locations on the deck of the car, as described below.
F	4	Shackles. Attach one shackle to each tow lug.
G	1	Brace. Length as required. Force-fit between hull and bottom of gun barrel. (Not required if howitzer has an operable external gun-tube brace.)
H	1	Strapping. Place over gun barrel and nail to item G with two 6d nails on each side. (Not required if howitzer has an operable external gun-tube brace.)
I	2	Wire rope, 3/8-inch. Wrap gun tube with cushioning material, item K. Place thimbles on the lifting eyes and apply wire rope in two complete loops: one around gun tube to left-rear lifting eye, the other around gun tube to right-rear lifting eye. Pull loops hand tight. (Not required if howitzer has an operable external gun-tube brace.)
J	6	Clips. Secure ends of wire rope (item I) with two 3/8-inch U-bolt clips at overlap area. Secure each thimble to wire rope with one 5/8-inch U-bolt clip. (Not required if howitzer has an operable external gun-tube brace.)
K	as required	Padding. Place under wire rope (item I) to protect gun barrel. (Not required if howitzer has an operable external gun-tube brace.)
RT1	3	Chains. Attach chains to the right-front tiedown fitting shackle from chain anchors in D35, C34, and D34.
LT1	3	Chains. Attach chains to the left-front tiedown fitting shackle from chain anchors in A34, B34, and A35.
RT2	3	Chains. Attach chains to the right-rear tiedown fitting shackle from chain anchors in D10, C11, and D11.
LT2	3	Chains. Attach chains to the left-rear tiedown fitting shackle from chain anchors in A11, B11, and A10.

GENERAL INSTRUCTIONS

1. M109 brakes must be set. Transmission selector must be in neutral.
2. Gun must be secured in the gun travel lock. The turret rotation and gun-elevating controls must be wire-tied, if feasible, to prevent movement of turret and gun.
3. Turnbuckles of front and rear chain tiedowns must be tightened at the same time to avoid disturbing the tank position.
4. Also applicable are General Rules 4, 5, 7, 11, 15(g), 19, 19A, and 19C in Section 1 of the Rules Governing the Loading of Commodities on Open-Top Cars and Trailers, published by the Association of American Railroads. These general rules are also found in TM 55-2200-001-12.

Table 7-3. Application of Materials for Securing Two M09 Self-Propelled Howitzers (Fig 7-2)

Item	No. Required	Application
A thru D		Channels. For description, refer to paragraph 2-2c.
E	24	Chains. Furnished with flatcar. Apply chains between M109 tiedown fittings and anchor locations on the deck of the car, as shown in figure 7-2 and described below.
F	8	Shackles. Attach one shackle to each tow lug.
G	2	Braces. Length as required. Force-fit between hull and bottom of gun barrel. (Not required if howitzer has an operable external gun-tube brace.)
H	2	Strapping. Place over gun barrel and nail to item G with two 6d nails on each side. (Not required if howitzer has an operable external gun-tube brace.)
I	4	Wire rope, 3/8-inch. Wrap gun tube with cushioning material, item K. Place thimbles on the lifting eyes and apply wire rope in two complete loops: one around gun tube to left-rear lifting eye, the other around gun tube to right-rear lifting eye. Pull loops hand tight.
J	12	Clips. Secure ends of wire rope (item I) with two 3/8-inch U-bolt clips at overlap area. Secure each thimble to wire rope with one 5/8-inch U-bolt clip. (Not required if howitzer has an operable external gun-tube brace.)
K	as required	Padding. Place under wire rope (item I) to protect gun barrel. (Not required if howitzer has an operable external gun-tube brace.)
<i>M109 HOWITZER NO. 1</i>		
RT1	3	Chains. Attach chains to the right-front tiedown fitting shackle from chain anchors in D43, C42, and D42.
LT1	3	Chains. Attach chains to the left-front tiedown fitting shackle from chain anchors in A42, B42, and A43.
RT2	3	Chains. Attach chains to the right-rear tiedown fitting shackle from chain anchors in D21, C22, and D22.
LT2	3	Chains. Attach chains to the left-rear tiedown fitting shackle from chain anchors in A22, B22, and A21.
<i>M109 HOWITZER NO. 2</i>		
RT1	3	Chains. Attach chains to the right-front tiedown fitting shackle from chain anchors in D24, C23, and D23.
LT1	3	Chains. Attach chains to the left-front tiedown fitting shackle from chain anchors in A23, B23, and A24.
RT2	3	Chains. Attach chains to the right-rear tiedown fitting shackle from chain anchors in D2, C3, and D3.
LT2	3	Chains. Attach chains to the left-rear tiedown fitting shackle from chain anchors in A3, B3, and A2.

GENERAL INSTRUCTIONS

1. M109 brakes must be set. Transmission selector must be in neutral.
2. Gun must be secured in the gun travel lock. The turret rotation and gun-elevating controls must be wire-tied, if feasible, to prevent movement of turret and gun.
3. Turnbuckles of front and rear chain tiedowns must be tightened at the same time to avoid disturbing the tank position.
4. Also applicable are General Rules 4, 5, 7, 11, 15(g), 19, 19A, and 19C in Section 1 of the Rules Governing the Loading of Commodities on Open-Top Cars and Trailers, published by the Association of American Railroads. These general rules are also found in TM 55-2200-01-12.

Table 7-4. Application of Materials for Securing One M109 Howitzer Facing the Opposite Direction from that Shown in Figure 7-1
(For location of "items," refer to fig 7-1)

Item	No. Required	Application
A thru D		Channels. For description, refer to paragraph 2-2c.
E	12	Chains. Furnished with flatcar. Apply chains between M109 tiedown fittings and anchor locations on the deck of the car, as described below.
F	4	Shackles. Attach one shackle to each tow lug.
G	1	Brace. Length as required. Force-fit between hull and bottom of gun barrel. (Not required if howitzer has an operable external gun-tube brace.)
H	1	Strapping. Place over gun barrel and nail to item G with two 6d nails on each side. (Not required if howitzer has an operable external gun-tube brace.)
I	2	Wire rope, 3/8-inch. Wrap gun tube with cushioning material, item K. Place thimbles on the lifting eyes and apply wire rope in two complete loops: one around gun tube to left-rear lifting eye, the other around gun tube to right-rear lifting eye. Pull loops hand tight. (Not required if howitzer has an operable external gun-tube brace.)

Table 7-4. Application of Materials for Securing One M109 Howitzer Facing the Opposite Direction from that Shown in Figure 7-1
(For location of "items, " refer to fig 7-1)Continued

Item	No. Required	Application
J	6	Clips. Secure ends of wire rope (item I) with two 3/8-inch U-bolt clips at overlap area. Secure each thimble to wire rope with one 5/8-inch U-bolt clip. (Not required if howitzer has an operable external gun-tube brace.)
K	as required	Padding. Place under wire rope (item I) to protect gun barrel. (Not required if howitzer has an operable external gun-tube brace.)
RT1	3	Chains. Attach chains to the right-front tiedown fitting shackle from chain anchors in A10, A11, and B11.
LT1	3	Chains. Attach chains to the left-front tiedown fitting shackle from chain anchors in D11, C11, and D10.
RT2	3	Chains. Attach chains to the right-rear tiedown fitting shackle from chain anchors in A35, B34, and A34.
LT2	3	Chains. attach chains to the left-rear tiedown fitting shackle from chain anchors in D34, C34, and D35.

GENERAL INSTRUCTIONS

1. M109 brakes must be set. Transmission selector must be in neutral.
2. Gun must be secured in the gun travel lock. The turret rotation and gun-elevating controls must be wire-tied, if feasible, to prevent movement of turret and gun.
3. Turnbuckles of front and rear chain tiedowns must be tightened at the same time to avoid disturbing the tank position.
4. Also applicable are General Rules 4, 5, 7, 11, 15(g), 19, 19A, and 19C in Section 1 of the Rules Governing the Loading of Commodities on Open-Top Cars and Trailers, published by the Association of American Railroads. These general rules are also found in TM 55-2200-001-12.

Table 7-5. Application of Materials for Securing One M109 Howitzer Facing the Opposite Direction from that Shown in Figure 7-2
(For location of "items, " refer to fig 7-1)

Item	No. Required	Application
A thru D		Channels. For description, refer to paragraph 2-2c.
E	24	Chains. Furnished with flatcar. Apply chains between M109 tiedown fittings and anchor locations on the dock of the car, as described below.
F	8	Shackles. Attach one shackle to each tow lug.
G	2	Brace. Length as required. Force-fit between hull and bottom of gun barrel. (Not required if howitzer has an operable external gun-tube brace.)
H	2	Strapping. Place over gun barrel and nail to item G with two 6d nails on each side. (Not required if howitzer has an operable external gun-tube brace.)
I	4	Wire rope, 3/8-inch. Wrap gun tube with cushioning material, item K. Place thimbles on the lifting eyes and apply wire rope in two complete loops: one around gun tube to left-rear lifting eye, the other around gun tube to right-rear lifting eye. Pull loops hand tight. (Not required if howitzer has an operable external gun-tube brace.)
J	12	Clips. Secure ends of wire rope (item I) with two 3/8-inch U-bolt clips at overlap area. Secure each thimble to wire rope with one 5/8-inch U-bolt clip. (Not required if howitzer has an operable external gun-tube brace.)
K	as required	Padding. Place under wire rope (item I) to protect gun barrel. (Not required if howitzer has an operable external gun-tube brace.)
M100 HOWITZER NEAR POSITION NO. 1		
RT1	3	Chains. Attach chains to the right-front tiedown fitting shackle from chain anchors in A2, B3, and A3.
LT1	3	Chains. Attach chains to the left-front tiedown fitting shackle from chain anchors in D3, C3, and D2.
RT2	3	Chains. Attach chains to the right-rear tiedown fitting shackle from chain anchors in A24, B23, and A23.
LT2	3	Chains. attach chains to the left-rear tiedown fitting shackle from chain anchors in D23, C23, and D24.
M109 HOWITZER NEAR POSITION NO. 44		
RT1	3	Chains. Attach chains to the right-front tiedown fitting shackle from chain anchors in A21, B22, and A22.
LT1	3	Chains. Attach chains to the left-front tiedown fitting shackle from chain anchors in D22, C22, and D21.

Table 7-5. Application of Materials for Securing One M109 Howitzer Facing the Opposite Direction from that Shown in Figure 7-2
(For location of "items, "refer to fig 7-1)-Continued

Item	No. Required	Application
RT2	3	Chains. Attach chains to the right-rear tiedown fitting shackle from chain anchors in A43, B42, and A42.
LT2	3	Chains. Attach chains to the left-rear tiedown fitting shackle from chain anchors in D42, C42, and D43.

GENERAL INSTRUCTIONS

1. M109 brakes must be set. Transmission selector must be in neutral.
2. Gun must be secured in the gun travel lock. The turret rotation and gun-elevating controls must be wire-tied, if feasible, to prevent movement of turret and gun.
3. Turnbuckles of front and rear chain tiedowns must be tightened at the same time to avoid disturbing the tank position.
4. Also applicable are General Rules 4, 5, 7, 11, 15(g), 19, 19A, and 19C in Section 1 of the Rules Governing the Loading of Commodities on Open-top Cars and Trailers, published by the Association of American Railroads. These general rules are also found in TM 55-2200-001-12.

CHAPTER 8

TRANSPORT OF CONTAINERS

8-1. Scope

This chapter provides guidance for transport of International Standards Organization (ISO) containers on the 140-ton flatcar and prescribes the securement procedures.

8-2. General

The flatcar has 12 built-in corner pedestals designed to fit and secure ISO containers. The flatcar can accommodate three 20-foot containers, as shown in figure 8-1, or one 40-foot container and one 20-foot container, as shown in figure 8-2. When not in use, the pedestals are folded flat against the treadways of the flatcar. When in the raised position, the pedestals support the containers about 6 inches above the car deck. Each pedestal has a hook that automatically engages a slot in the corner fitting of the container. No other securement is needed. The car deck is stenciled to indicate which pedestal positions are to be used for each combination of containers.

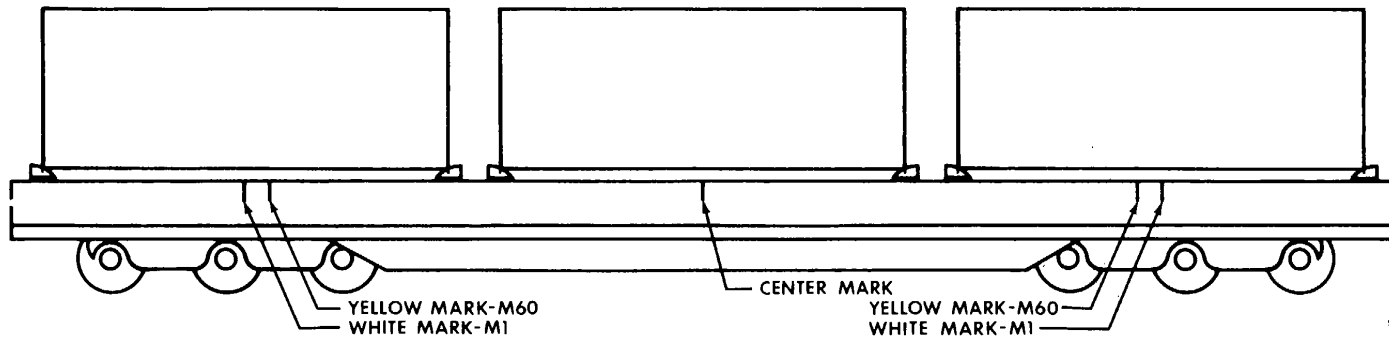

Figure 8-1. Three 25foot ISO containers secured in pedestals.

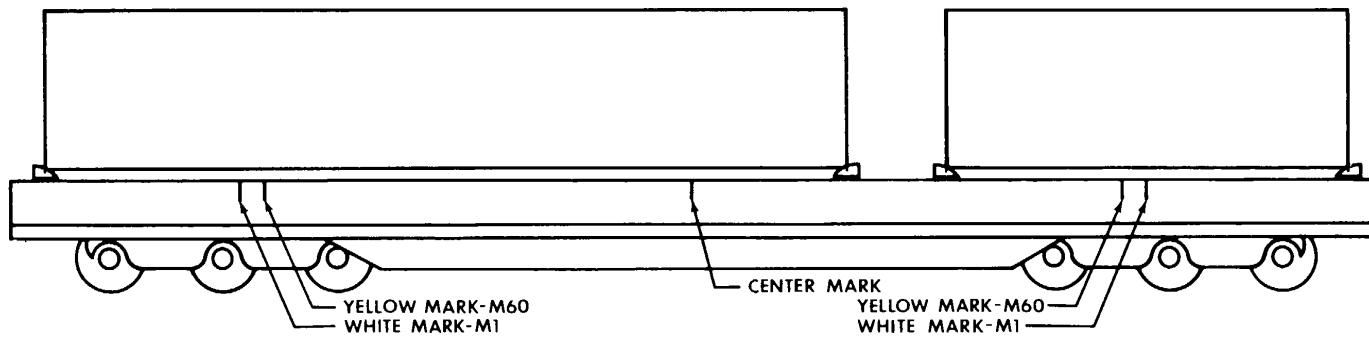

Figure 8-2. One 4-foot ISO container and one 50-foot ISO container secured in pedestals.

APPENDIX A

REFERENCES

1. Army Regulations (AR)

55-355 Military Traffic Management Regulation
 746-1 Color, Marking, and Preparation of Equipment for Shipment

2. Army Technical Manuals (TM)

9-2320-222-10 Operator's Manual: M88 Recovery Vehicle
 9-2350-215-10 Operator's Manual: M60-Series Tanks
 9-2350-217-10 Operator's Manual: M108 and M109 Self-Propelled Howitzers
 9-2350-255-10 Operator's Manual: M1 Tank
 55-2200-001-12 Transportability Guidance: Application of Blocking, Bracing, and Tiedown
 Materials for Rail Transport
 55-2320-222-10-1 Transportability Guidance: M88 Recovery Vehicle
 55-2350-215-10-15 Transportability Guidance: Tank, Combat, Full-Tracked, M60-Series
 55-2350-217-15-1 Transportability Guidance: M108 and M109 Self-Propelled Howitzers
 55-2350-255-14 Transportability Guidance: Tank, Combat Full-Tracked, 105-mm Gun, M1

3. Other Publications and Sources of Procurement*a. Code of Federal Regulations, Title 49-Transportation, Parts 170-179*

Available from: Superintendent of Documents
 US Government Printing Office
 Washington, DC 20402

b. Association of American Railroads, Rules Governing the Loading of Commodities on Open-Top Cars and Trailers

Section No. 1- General Rules
 Section No. 6.- Rules Governing the Loading of Department of Defense Materiel on Open-
 Top Cars
 Available from: Association of American Railroads
 American Railroads Building
 50 F Street, NW
 Washington, DC 20001

APPENDIX B

MANUFACTURER PARTS LIST

<i>Noun Nomenclature</i>	<i>MacLean-Fogg Part No.</i>	<i>Midland Forge Part No.</i>
Anchors	61262	
Anti-Theft Device	(R-H)61666	
Anti-Theft Device	(L-H)61667	
Channel	61171	
Compression Unit	61211	
Container Pedestal	(R-H)61671	
Container Pedestal	(L-H)61672	
Claw Hook	61296	
Loadbinder	61207	
Master Ring	61283	
Ratchet Handle (Spanner Wrench)	61011	
Screw Pin Anchor Shackle	61284	MK0267
Sling Hook	61297	
V2 inch Alloy tiedown Chain	61298	
Y2 inch Coupling Link	68072	

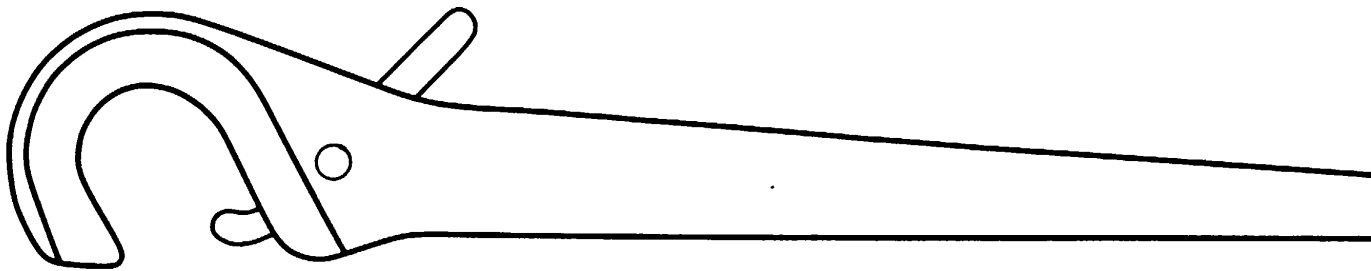

RATCHET HANDLE

Figure B-1. Ratchet handle.

BILL OF MATERIALS		
NO.	M- F PART #	DESCRIPTION
1	61262	MF HVY DTY ANCHOR
2	68072	MF 1/2" COUPLING LINK
3	61207	MF LOADBINDER
4	61211	MF HVY DUTY COUPLING
5	68072	MF 1/2" COUPLING LINK
6	61296	MF CLAW HOOK
7	61298	1/2" ALLOY CHAIN
8	61297	1/2" ALLOY SLING HOOK

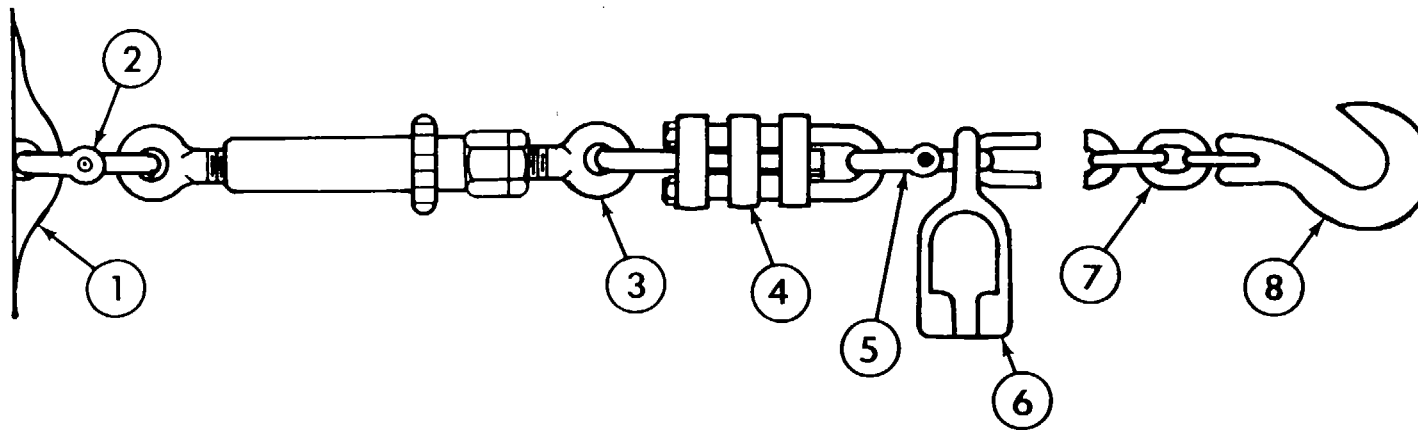

ANCHOR / CHAIN ASSEMBLY

Figure B-2. Anchor/Chain assembly.

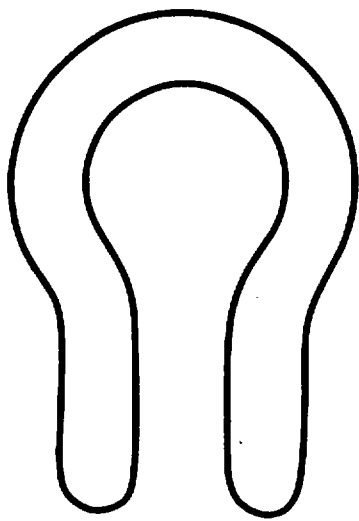

SHACKLE

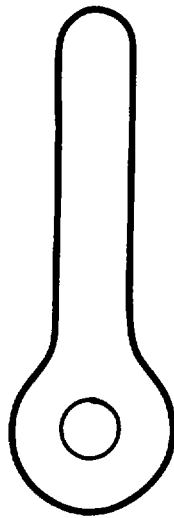

SCREW PIN

Figure B-3. Alloy shackle

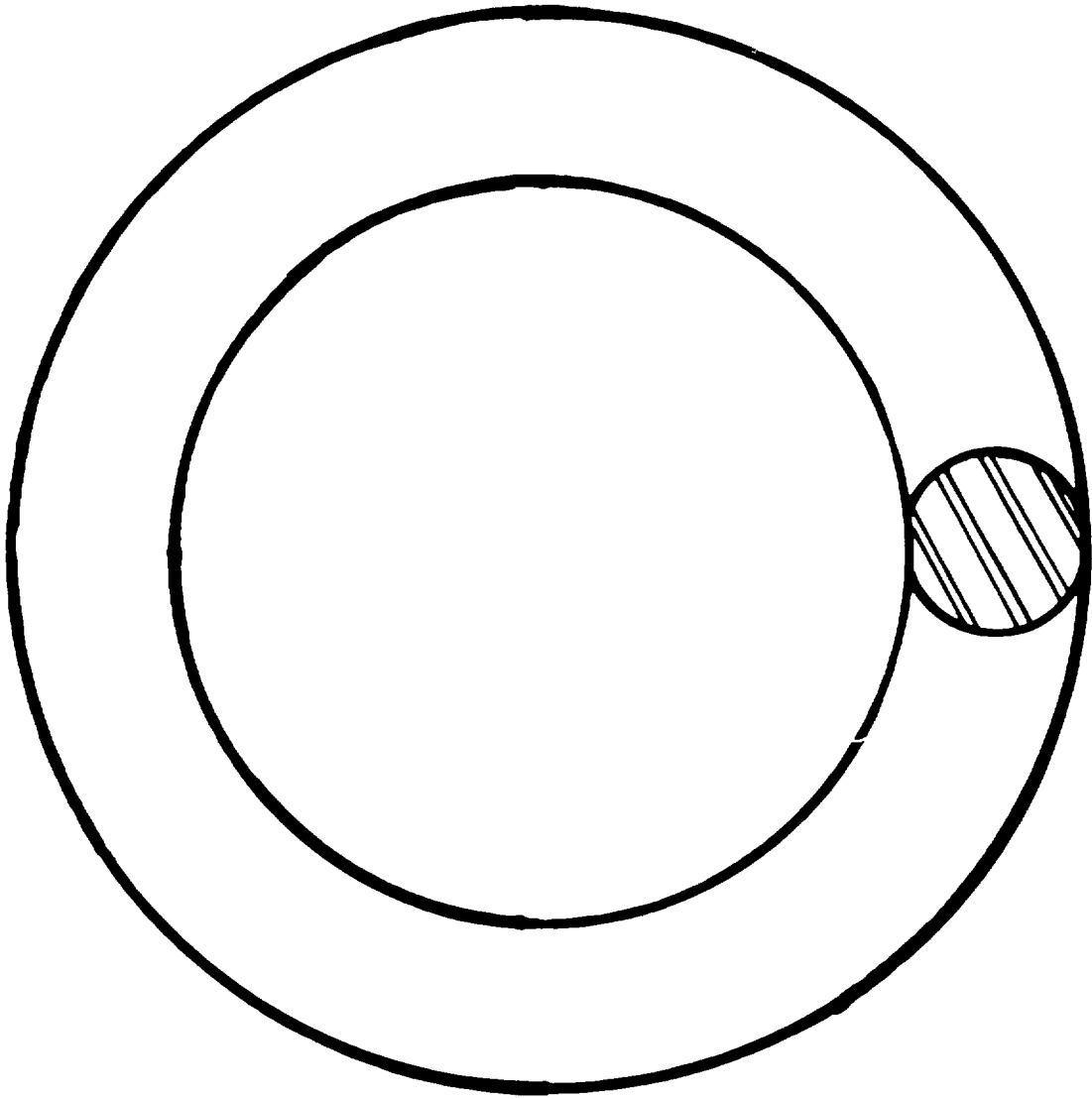

ALLOY MASTER RING

Figure B-4. Alloy master ring.

By order of the Secretary of the Army:

Official:

R. L. DILWORTH
Brigadier General, United States Army
The Adjutant General

*JOHN A. WICKHAM, JR. General, United
States Army Chief of Staff*

Distribution:

To be distributed in accordance with DA Form 12-34B requirements for Transportation Guidance, Transportation of Cargo on Rail Car, Flat, 140-Ton Capacity and DA Form 12-37, Organizational Maintenance requirements for Howitzer, Medium, Self-Propelled, 155-MM, M109, M109A1, M109A3, Vehicle Recovery, Medium, Full Tracked, M88A1, Tank, Combat, Full Tracked, 105-MM, M60, M60A1 Hull and M60A1 AOS Vehicle, Combat, Engineer, Full Tracked, M728, Tank, Combat, Full Tracked, 105-MM, M60A1 RISE and M60A1 RISE PASSIVE, 105-MM, M1 Abrams, Howitzer, Medium, Self-Propelled, 15-MM, M109A2.

☆U.S. GOVERNMENT PRINTING OFFICE: 1987 0-178-496

☆ U.S. GOVERNMENT PRINTING OFFICE: 1990 0 - 262-912 (30707)

RECOMMENDED CHANGES TO EQUIPMENT TECHNICAL PUBLICATIONS



THEN...JOT DOWN THE DOPE ABOUT IT ON THIS FORM. CAREFULLY TEAR IT OUT, FOLD IT AND DROP IT IN THE MAIL.

SOMETHING WRONG WITH PUBLICATION

FROM: (PRINT YOUR UNIT'S COMPLETE ADDRESS)

DATE SENT

PUBLICATION NUMBER

PUBLICATION DATE

PUBLICATION TITLE

BE EXACT PIN-POINT WHERE IT IS

PAGE NO.	PARA-GRAPH	FIGURE NO.	TABLE NO.

IN THIS SPACE, TELL WHAT IS WRONG AND WHAT SHOULD BE DONE ABOUT IT.

TEAR ALONG PERFORATED LINE

PRINTED NAME, GRADE OR TITLE AND TELEPHONE NUMBER

SIGN HERE

