

Field Operations Guide

**For Disaster Assessment
and Response**



USAID

FROM THE AMERICAN PEOPLE

**U.S. Agency for
International Development**

**Bureau for Democracy, Conflict,
and Humanitarian Assistance
Office of U.S. Foreign Disaster Assistance**

**In cooperation with and produced by
The USDA Forest Service
International Programs
Disaster Assistance Support Program**

**Version 4.0
September 2005**

Emergency Indicators and Minimum Standards

Malnutrition Emergency Definitions

Global Acute Malnutrition (GAM) = Severe Acute Malnutrition (SAM) + Moderate Acute Malnutrition (MAM)

GAM for <5 age group

Z-Score <-2 MUAC <13.5 cm WFH/WFL <80%

SAM for <5 age group

Z-Score <-3 MUAC <11.0 cm WFH/WFL <70%

MAM for <5 age group

Z-Score >-3 and <-2 MUAC >11.0 and <13.5 cm WFH/WFL >70% and <80%

See section D of chapter III, Interpretation of Malnutrition Rates and Corresponding Actions, for malnutrition indicators.

Mortality Rate Emergency Indicators

Crude Mortality Rate (CMR): single most important indicator of serious stress in affected populations

CMR = deaths/10,000/day: emergency phase

- <1 = Under control
- >1 = Serious condition
- >2 = Out of control
- >4 = Major catastrophe

Mortality rate for <5 age group

- 1 = Normal in a developing country
 - <2 = Emergency phase: under control
 - >2 = Emergency phase: in serious trouble
 - >3 = Emergency phase: out of control
-

Minimum Water Requirements

- Minimum maintenance = 15 liters/person/day
- Feeding centers = 30 liters/inpatient/day
- Health centers and hospitals = 40–60 liters/inpatient/day
- 1 tap stand/250 people not >100m from users

A large quantity of reasonably safe water is preferable to a small amount of pure water

Minimum Food Requirements

Minimum maintenance = 2,100 Kcals/person/day

Minimum Shelter/Space Requirements

- Minimum shelter space = 3.5 m²/person
 - Minimum total site area = 45 m²/person for temporary planned or self-settled camps
-

Minimum Sanitation Requirements

At least 1 toilet for every 20 persons

Maximum of 1 minute walk from dwelling to toilet (≥6m and ≤50m)

CONTENTS

Introductionxvii
Policy Guidelinesxix
Chapter I: General Responsibilities and InformationI-1
A. Individual Team Member ChecklistI-2
1. Personal Items and Related TipsI-2
2. Optional Items (Bring at Your Own Risk)I-3
3. Personal Health Items and Medical TipsI-3
4. OFDA-Provided ItemsI-4
5. Information To Be Left With OFDA/WI-4
B. Team Support ChecklistI-4
C. DocumentationI-5
1. GeneralI-5
2. Types of DocumentationI-6
D. Accountability and LiabilityI-6
1. EquipmentI-6
2. AccountabilityI-7
3. LiabilityI-8
E. AdministrationI-8
1. Time RecordsI-8
2. Per Diem and VouchersI-9
3. Procurement and ContractingI-9
F. Safety and SecurityI-9
1. Safety and Security ChecklistI-10
G. Personal Health and Critical-Incident StressI-11
1. BriefingsI-12
2. Managing Culture ShockI-12
3. Critical-Incident StressI-12
4. How Team Members May Be Affected by Stress During Disaster OperationsI-13
5. How To Minimize Stress During a Disaster OperationI-14

Chapter II: Assessments	.II-1
A. Introduction	.II-2
B. Purpose of an Initial Assessment	.II-2
C. Assessment Team Composition	.II-4
D. Assessment Recommendations and Their Impact on Recovery	.II-4
E. Keys to a Successful Assessment	.II-5
1. Identify the Users	.II-5
2. Identify the Information Needed To Plan Specific Programs	.II-5
3. Consider the Format	.II-6
4. Consider the Timing of the Assessment	.II-6
5. Determine the Best Places To Obtain Information	.II-6
6. Distinguish Between Emergency and Chronic Needs	.II-6
7. Assess Needs and Vulnerabilities in Relation to Capacities	.II-7
8. Use Recognized Terminology, Standards, and Procedures	.II-8
F. Types of Assessments	.II-8
1. Situation (Disaster) Assessment	.II-8
2. Needs Assessment	.II-9
3. Environmental Impact Assessment	.II-10
G. Elements of an Assessment	.II-11
1. Preparedness Planning	.II-11
2. Survey and Data Collection	.II-12
3. Interpretation	.II-12
4. Forecasting	.II-12
5. Reporting	.II-12
6. Monitoring	.II-12
H. Data Collection	.II-13
1. Data Collection Considerations	.II-13
2. Data Collection Methods	.II-14
I. OFDA Assessment Cable Reporting Formats	.II-15
1. Disaster Cable Format Considerations	.II-15
2. Who Should Get the Cable	.II-16

3.	Disaster Cable Contents	..II-17
a.	Subject	..II-17
b.	References	..II-17
c.	Summary	..II-17
d.	General Situation	..II-18
e.	Food and Food Distribution	..II-19
f.	Health and Nutrition	..II-19
g.	Water and Sanitation	..II-20
h.	Shelter	..II-21
i.	Capability and Capacity	..II-22
j.	Coordination	..II-22
k.	Recommendations	..II-22
J.	Assessment Checklists	..II-22
1.	Introduction	..II-22
2.	Victims/Displaced Population Profile	..II-23
a.	General Characteristics	..II-23
b.	Capacities	..II-23
c.	Displaced Populations	..II-24
d.	Physical Assets	..II-24
3.	Food	..II-25
a.	Baseline Data	..II-25
b.	Effect of the Event on Food	..II-25
c.	Food Availability	..II-26
d.	Distribution Systems	..II-27
e.	Social and Market Impact of Food Aid	..II-27
f.	Other	..II-27
4.	Nutrition	..II-28
a.	Nutritional Status	..II-28
b.	Public Health-Related Risk of Malnutrition	..II-29
c.	Care-Related Risk of Malnutrition	..II-29
d.	Food Access-Related Risk of Malnutrition	..II-30
e.	Nutrition Interventions	..II-30
5.	Health	..II-31
a.	Health and Demographic Information	..II-31
b.	HIV/AIDS	..II-32
c.	Health System Capabilities	..II-32
d.	Local Health Programs	..II-33
e.	Health Information/Surveillance Systems	..II-34
f.	Cultural and Social Health Factors	..II-35
g.	Environmental Health Factors	..II-35
6.	Water	..II-36
a.	Displaced Population Situation	..II-36
b.	Water System Disruption	..II-36

7. Sanitation	..II-37
a. Displaced Population Situation	..II-37
b. Nondisplaced Population Situation	..II-37
8. Shelter and Settlements	..II-38
a. Establishing Context	..II-38
b. Identifying Impacts, Resources, and Opportunities	..II-39
9. Agriculture and Livestock	..II-42
a. Baseline Data	..II-42
b. Effect of the Event on Agriculture	..II-43
c. Effect of the Event on Livestock	..II-44
d. Agricultural Production Capabilities	..II-45
e. Other	..II-46
10. Search and Rescue	..II-46
11. Logistics	..II-47
a. Airports	..II-47
b. Civil Aviation	..II-48
c. Alternative Aircraft	..II-49
d. Seaports	..II-49
e. Transfer Points	..II-51
f. Trucking	..II-51
g. Railroads	..II-52
h. Warehousing	..II-52
12. Infrastructure	..II-54
a. Communications	..II-54
b. Electric Power	..II-56
c. Community Water Supply and Wastewater Treatment/Disposal	..II-57
d. Hydraulic Structures (Dams, Levees, Irrigation Canals, Hydropower Facilities)	..II-58
e. Roads and Bridges	..II-59

Chapter III: Information on Populations at Risk

Chapter III: Information on Populations at Risk	..III-1
A. Introduction	..III-2
B. Immediate Response	..III-2
1. Protection of Populations at Risk	..III-2
a. Protection Problems	..III-3
b. Possible Actions	..III-4
2. Organizational Considerations for Displaced Persons	..III-6
3. Material Assistance	..III-6

C. Water	III-8
1. General	III-8
a. Evaluating Water Sources	III-9
b. Water System Considerations	III-10
2. Determining Water Needs	III-11
a. Quantity	III-11
b. Quality	III-13
3. Immediate Response	III-15
4. Water Source	III-17
a. Freshwater Sources	III-17
(1) Surface Water	III-17
(2) Ground Water	III-17
(3) Rainwater	III-18
b. Seawater	III-19
c. Water Source Considerations	III-19
5. Storage	III-22
6. Distribution	III-23
7. Treatment	III-24
a. Storage	III-25
b. Sand Filtration	III-25
c. Coagulation and Flocculation	III-26
d. Chemical Disinfection	III-26
e. Boiling	III-28
D. Food and Nutrition	III-28
1. Basic Facts About Food and Nutrition	III-28
a. Nutrients	III-28
b. Energy and Protein Intakes	III-29
c. Food and Diets	III-29
2. Food Security	III-29
3. Malnutrition Causes and Interventions	III-30
a. Malnutrition Causes	III-30
b. Considerations in Selecting Interventions	III-31
4. Nutritional Diseases	III-32
a. Protein-Energy Malnutrition	III-32
(1) Nutritional Marasmus	III-33
(2) Kwashiorkor	III-33
(3) Marasmic Kwashiorkor	III-34
b. Micronutrient Deficiency Diseases	III-34
(1) Vitamin A Deficiency (VAD)	III-34
(2) Vitamin C Deficiency (Scurvy)	III-34
(3) Niacin Deficiency (Pellagra)	III-35
(4) Anemia	III-35
(5) Thiamine Deficiency (Beriberi)	III-35

5.	Nutritional Surveillance Methods	..III-36
a.	Sampling Methods	..III-36
(1)	Systematic Random Sampling	..III-36
(2)	Cluster Sampling	..III-37
b.	Malnutrition Measurement Methods	..III-38
(1)	Weight-for-Height (Weight-for-Length) Method	..III-39
(2)	MUAC Method	..III-44
(3)	Interpretation of Malnutrition Rates and Corresponding Actions	..III-45
6.	General Feeding Programs	..III-46
a.	Types of Food Distribution	..III-50
(1)	Dry Ration Distribution (Take Home)	..III-50
(2)	Wet Ration Distribution	..III-52
7.	Selective Feeding Programs	..III-52
a.	Supplementary Feeding Programs	..III-53
(1)	Blanket SFPs	..III-54
(2)	Targeted SFPs	..III-55
b.	Exit Criteria	..III-56
c.	Supplementary Food Quantities	..III-56
d.	Organization and Management of an SFP	..III-56
8.	Community Therapeutic Care Programs	..III-57
9.	Therapeutic Feeding Programs	..III-57
10.	Infant Feeding and Milk Products	..III-59
11.	Food Commodities	..III-60
a.	Nutritional Value of Food Commodities	..III-60
b.	Food Aid Storage Requirements	..III-63
E.	Health	..III-63
1.	Introduction	..III-63
2.	Background Information for Initial Health Assessments	..III-64
a.	Epidemiologic Concepts	..III-64
b.	Epidemiologic Definitions	..III-65
c.	Mortality and Morbidity Rates	..III-66
(1)	Mortality Rate	..III-66
(2)	Morbidity Rate	..III-68
3.	Prevention and Control of Infectious Diseases	..III-68
a.	Introduction	..III-68
b.	Common Diseases in Emergencies	..III-70
(1)	Acute Respiratory Infections	..III-70
(2)	Diarrheal Diseases	..III-71
(3)	Cholera	..III-73
(4)	Shigellosis (Bacillary Dysentery)	..III-75

(5) HIV/AIDS	III-76
(6) Measles	III-77
(7) Malaria	III-79
(8) Meningococcal Meningitis	III-82
(9) Tuberculosis (TB)	III-84
4. Health Care Provision	III-85
a. Health Care Personnel	III-86
b. Levels of Health Care Treatment	III-87
5. Health Education	III-89
6. Medical Supplies	III-89
a. The New Emergency Health Kit	III-89
b. Vaccines	III-90
c. OFDA Guidelines for Pharmaceutical Donations	III-91
F. Shelter and Settlements	III-92
1. Background	III-92
2. Shelter Interventions	III-92
3. Camps: When Other Shelter Interventions Are Not Possible	III-97
a. Criteria for Site Selection	III-98
(1) Social Needs	III-98
(2) Water	III-98
(3) Open Space	III-98
(4) Accessibility	III-99
(5) Environmental Considerations	III-99
(6) Soil and Ground Cover	III-99
(7) Land Rights	III-99
b. Site Planning	III-100
(1) Latrines	III-100
(2) Water Distribution	III-100
(3) Roads and Pathways	III-101
(4) Firebreaks	III-101
(5) Administrative and Community Services	III-101
(6) Physical Layout	III-102
G. Sanitation and Environmental Health Services	III-103
1. General	III-103
2. Importance of Organization, Integration, and Selection	III-103
3. Disposal of Excreta	III-104
a. Selection of a System—Immediate Considerations	III-105
b. Immediate Action	III-106

c.	Longer Term Options	..III-108
d.	Latrine Styles and Considerations	..III-108
(1)	Number and Siting of Latrines	..III-108
(2)	Population Density	..III-109
(3)	Soil	..III-109
(4)	Available Water	..III-110
(5)	Drainage	..III-110
(6)	Construction Materials	..III-110
4.	Wastewater (Greywater), Garbage, and Dust	..III-111
a.	Wastewater (Greywater)	..III-111
b.	Garbage	..III-111
c.	Dust	..III-112
5.	Insect and Rodent Control	..III-112
6.	Fires	..III-114
a.	Prevention	..III-114
b.	Control	..III-114
7.	Funeral Services	..III-115
H.	Agriculture and Livestock	..III-116
1.	Seed Security	..III-116
a.	Evaluating Seed System Interventions	..III-117
2.	Livestock	..III-118
a.	Evaluating Livestock Interventions	..III-119

Chapter IV: Disaster Assistance Response Team ..IV-1

A.	Overview	..IV-3
1.	Purpose	..IV-3
2.	Structure	..IV-4
3.	DART Activation and Deployment	..IV-5
B.	DART Setup and Closeout Guidelines	..IV-6
1.	Introduction	..IV-6
2.	Setup	..IV-6
a.	Files and Recordkeeping	..IV-6
(1)	Sensitive but Unclassified Data	..IV-7
(2)	Electronic Storage	..IV-8
b.	Contact List	..IV-8
c.	Program Management	..IV-8
d.	Packaging	..IV-9
e.	DART Headquarters	..IV-9
3.	Closeout	..IV-10
a.	The Date	..IV-10
b.	Administration	..IV-10

c.	Personnel	IV-10
d.	Moving and Transferring Files	IV-10
e.	Program Management	IV-11
f.	Public Relations	IV-12
g.	OFDA Funds	IV-12
h.	Transfer of Property	IV-12
i.	Communications	IV-13
j.	Closeout Memo	IV-13
C.	Working With the Response Management Team ..	IV-13
1.	Overview	IV-13
2.	Purpose	IV-14
3.	Activation	IV-14
4.	Demobilization	IV-15
5.	Structure	IV-15
D.	Working With the Media	IV-16
1.	General	IV-16
2.	Ensure Close Coordination	IV-16
3.	Develop a Strategy and Plan	IV-16
4.	Know Your Story	IV-17
5.	Rules for Dealing With Reporters	IV-17
E.	General Checklist for All DART Members	IV-19
1.	Predeparture	IV-19
2.	In Transit	IV-20
3.	In-Country	IV-20
a.	Immediate Actions	IV-20
b.	Ongoing Actions	IV-21
4.	Demobilization	IV-22
F.	Management/Liaison Functional Area	IV-23
1.	Team Leader	IV-23
a.	Predeparture	IV-23
b.	In-Country	IV-25
(1)	Immediate Actions	IV-25
(2)	Ongoing Actions	IV-26
c.	Demobilization	IV-27
2.	Deputy Team Leader	IV-28
a.	Predeparture	IV-29
b.	In-Country	IV-29
(1)	Immediate Actions	IV-29
(2)	Ongoing Actions	IV-30
c.	Demobilization	IV-31

3.	Press Officer	IV-32
a.	Predeparture	IV-32
b.	In-Country	IV-33
	(1) Immediate Actions	IV-33
	(2) Ongoing Actions	IV-34
c.	Demobilization	IV-34
4.	Safety/Security Officer	IV-34
a.	Predeparture	IV-35
b.	In-Country	IV-35
	(1) Immediate Actions	IV-35
	(2) Ongoing Actions	IV-36
c.	Demobilization	IV-36
5.	Liaison Officer	IV-36
a.	Predeparture	IV-37
b.	In-Country	IV-37
	(1) Immediate Actions	IV-37
	(2) Ongoing Actions	IV-37
c.	Demobilization	IV-38
6.	Contracting Officer	IV-38
a.	Predeparture	IV-38
b.	In-Country	IV-39
	(1) Immediate Actions	IV-39
	(2) Ongoing Actions	IV-39
c.	Demobilization	IV-40
G.	Logistics Section	IV-40
1.	Logistics Coordinator	IV-40
a.	Predeparture	IV-41
b.	In-Country	IV-41
	(1) Immediate Actions	IV-41
	(2) Ongoing Actions	IV-43
c.	Demobilization	IV-44
2.	Fleet Manager	IV-44
a.	Predeparture	IV-44
b.	In-Country	IV-45
	(1) Immediate Actions	IV-45
	(2) Ongoing Actions	IV-45
c.	Demobilization	IV-46
3.	Aviation Officer	IV-46
4.	Supply Officer	IV-46
H.	Communications Section	IV-46
1.	Communications Officer	IV-47
a.	Predeparture	IV-47

b.	In-Country	IV-48
(1)	Immediate Actions	IV-48
(2)	Ongoing Actions	IV-48
c.	Demobilization	IV-49
I.	Operations Section	IV-49
1.	Operations Coordinator	IV-49
a.	Predeparture	IV-50
b.	In-Country	IV-50
(1)	Immediate Actions	IV-50
(2)	Ongoing Actions	IV-51
c.	Demobilization	IV-51
2.	Medical Officer	IV-51
a.	Predeparture	IV-51
b.	In-Country	IV-52
(1)	Immediate Actions	IV-52
(2)	Ongoing Actions	IV-53
c.	Demobilization	IV-53
3.	Urban Search and Rescue Task Force Leader	IV-53
a.	Predeparture	IV-53
b.	In-Country	IV-54
(1)	Immediate Actions	IV-54
(2)	Ongoing Actions	IV-54
c.	Demobilization	IV-54
4.	Technical/Scientific Operations Specialists	IV-54
a.	Predeparture	IV-55
b.	In-Country	IV-55
(1)	Immediate Actions	IV-55
(2)	Ongoing Actions	IV-56
c.	Demobilization	IV-56
J.	Planning Section	IV-57
1.	Planning Coordinator	IV-57
a.	Predeparture	IV-57
b.	In-Country	IV-58
(1)	Immediate Actions	IV-58
(2)	Ongoing Actions	IV-59
c.	Demobilization	IV-60
2.	Information Officer	IV-61
a.	Predeparture	IV-61
b.	In-Country	IV-62
(1)	Immediate Actions	IV-62
(2)	Ongoing Actions	IV-62
c.	Demobilization	IV-63

3. Field Officer	IV-63
a. Predeparture	IV-64
b. In-Country	IV-64
(1) Immediate Actions	IV-64
(2) Ongoing Actions	IV-64
c. Demobilization	IV-64
4. Program Officer	IV-65
a. Predeparture	IV-65
b. In-Country	IV-66
(1) Immediate Actions	IV-66
(2) Ongoing Actions	IV-66
c. Demobilization	IV-66
5. Technical/Scientific Operations Specialists	IV-67
a. Predeparture	IV-67
b. In-Country	IV-67
(1) Immediate Actions	IV-67
(2) Ongoing Actions	IV-68
c. Demobilization	IV-68
d. Types of Technical/Scientific Operations Specialists	IV-68
(1) Water and Sanitation Specialists	IV-68
(a) In-Country	IV-68
(2) Health Specialists	IV-69
(a) In-Country	IV-69
(3) Food Specialists	IV-70
(a) In-Country	IV-70
K. Administrative Section	IV-71
1. Administrative Officer	IV-71
a. Predeparture	IV-71
b. In-Country	IV-72
(1) Immediate Actions	IV-72
(2) Ongoing Actions	IV-74
c. Demobilization	IV-74
2. Administrative Support Specialist	IV-74
a. Predeparture	IV-75
b. In-Country	IV-75
(1) Ongoing Actions (Performed for Various Functions)	IV-75
c. Demobilization	IV-75
Chapter V: Commonly Used Acronyms and Terms	V-1

A. OFDA Acronyms and Terms	V-2
B. Department of Defense Acronyms and Terms	V-8

Appendixes

Appendix A: Field Situation Reporting

Format	A-1
1. DART field location, including city and country, and date	A-2
2. Disaster data including the sources of the information	A-2
3. Issues (political and others) arising or needing resolution and DART recommendations	A-3
4. DART activities since last report (sample types of information to report)	A-3
5. Activities of others	A-3
6. Actions requested of OFDA/W	A-3

Appendix B: OFDA Stockpile Commodities and DART Support Equipment

A. Introduction	B-2
B. Relief Commodities	B-3
1. Blankets	B-3
2. Water Containers, 10-Liter Collapsible	B-3
3. Hygiene Kits	B-3
4. Water Bladder Kit, 10,000-Liter	B-4
5. Water Treatment Units	B-4
6. Plastic Sheeting	B-4
a. General	B-4
b. Description	B-5
c. Distribution	B-6
d. How To Use Plastic Sheeting	B-6
C. DART Support Supplies and Equipment	B-9
1. OFDA Field Packs	B-9
2. Remote Location Kits	B-9

Appendix C: Aircraft Use and Capability and Ocean and Overland Transport

A. Aircraft Information	C-2
B. Points To Consider When Dealing With Aircraft	C-2

C. Aircraft Loading and Offloading Methods	C-3
D. Points To Consider When Planning To Receive Aircraft Cargo	C-5
E. Ocean and Overland Transport	C-13
Appendix D: DART Communications	D-1
A. Requirements	D-2
B. Systems	D-2
1. General	D-2
2. Local Phone System	D-3
3. Countrywide or International Cell Phones	D-3
4. Satellite Terminal Systems	D-4
5. HF/VHF/UHF Radio Networks and Systems	D-4
C. Policy on Use of Frequencies	D-6
D. Radio Identification and Communications Procedures	D-7
1. Radio Identification	D-7
2. Communications Procedures	D-8
Appendix E: Location Referencing and Mapping Resources	E-1
A. How To Reference Location	E-2
1. Precision	E-2
2. Coordinate Referencing Systems	E-4
B. Mapping Resources	E-6
1. Getting Started	E-6
2. Map Products	E-6
Appendix F: Working With the Military in the Field	F-1
A. Military Operations Involving Coordination With OFDA Disaster Response Activities	F-2
1. Natural Disasters	F-2
a. Point-to-Point Logistical Support	F-2
b. Disaster Relief	F-3

2.	Complex Emergencies	F-4
a.	Peace Operations	F-4
b.	Relief Operations During Conflict	F-4
B.	Characteristics of Military Culture	F-5
1.	Organizational Culture	F-5
a.	Meetings	F-5
b.	Coordination	F-6
c.	Operational View of the Mission	F-6
d.	Deployment	F-6
C.	Military Structure During Operations	F-7
1.	Chain of Command	F-7
2.	CC Authorities During Critical Humanitarian Relief Situations	F-7
3.	Humanitarian Assistance Survey Team	F-8
4.	Joint Task Force	F-8
5.	Civil Military Operations Center	F-8
6.	Special Operations Forces	F-9
a.	Civil Affairs	F-10
b.	PSYOPS	F-10
D.	Your Deployment With the Military	F-11
1.	Before Departing	F-11
2.	Arrival	F-11
3.	Getting Visibility	F-13
4.	Your Mission	F-13
5.	Meetings and Briefings in the JTF	F-13
6.	Contact and Visibility With the Affected Country, UN Relief Agencies, Private/International/Nongovernmental Organizations, and Donor Governments	F-14
7.	Staffing	F-14
8.	Reporting	F-15
9.	Support	F-15
10.	When Are You Done?	F-16
11.	Closeout	F-16
12.	Other Assignments	F-16

Appendix G: Chemical, Biological, Radiation, Nuclear, or Explosive HazardsG-1

A. Chemical HazardsG-2

B. Biological HazardsG-3

C. Radiation and Nuclear HazardsG-4

D. Explosive HazardsG-4

Appendix H: Monitoring and EvaluationH-1

A. MonitoringH-2

B. EvaluationH-3

INTRODUCTION

This *Field Operations Guide (FOG) for Disaster Assessment and Response* has been developed by the U.S. Agency for International Development/Bureau for Democracy, Conflict, and Humanitarian Assistance/Office of U.S. Foreign Disaster Assistance (OFDA) as a reference tool for individuals sent to disaster sites to undertake initial assessments or to participate as members of an OFDA Disaster Assistance Response Team (DART).

The FOG contains information on general responsibilities for disaster responders, formats and reference material for assessing and reporting on populations at risk, DART position descriptions and duty checklists, descriptions of OFDA stockpile commodities, general information related to disaster activities, information on working with the military in the field, and a glossary of acronyms and terms used by OFDA and other organizations with which OFDA works.

In developing the FOG, OFDA has drawn on many sources for information, including the United Nations High Commissioner for Refugees *Handbook for Emergencies*; the United Nations Office for the Coordination of Humanitarian Affairs *United Nations Disaster Assessment and Coordination Field Handbook*; the World Health Organization booklet, *New Emergency Health Kit*; the United Nations Children's Fund handbook, *Assisting in Emergencies*; the U.S. State Department, Bureau for Population, Refugees, and Migration *Assessment Manual for Refugee Emergencies*; the U.S. Public Health Service *Handbook of Environmental Health*; the American Public Health Association *Control of Communicable Diseases Manual*; the Sphere Project; reference materials from the Centers for Disease Control and Prevention, the University of Wisconsin's Disaster Management Center, the American Red Cross, and InterWorks; USAID policies and directives; information from the Office of Food for Peace, Office of Transition Initiatives, and the U.N. World Food Program; and OFDA procedures, records, and staff expertise.

The FOG's size and format are modeled on the National Wildfire Coordinating Group's *Fireline Handbook*, which is used by wild-land firefighters throughout the United States.

The search and rescue (SAR) component of a DART is more fully described in a separate operations guide developed by the Federal Emergency Management Agency, which specifically addresses SAR activities. These documents are available at <http://www.fema.gov>.

The FOG is designed to be a useful source of information in a compact, usable format for a variety of field operations. In the interest of conserving space and keeping the FOG to a manageable size, no index is provided. The extensive listing on the Contents page should assist in locating information quickly by specific subject. Comments for revision should be directed to:

USAID
DCHA/OFDA
Operations Division
Washington, DC 20523 USA

The FOG is posted on the World Wide Web at:
<http://www.info.usaid.gov/ofda/>

This publication (ISBN 0-16-049721-3) is also available through the U.S. Government Printing Office (GPO), Superintendent of Documents, Mail Stop: SSOP, Washington, DC 20402-9328.
<http://bookstore.gpo.gov/>

This is the third revision of the original *Guide to Field Operations for Disaster Response* produced in 1992, initially revised as the FOG in 1994 and updated in 1998. This revision includes new information that reflects changes and trends in humanitarian assistance since 1998. The FOG was developed for OFDA by the U.S. Department of Agriculture/Forest Service under its International Programs Office. That office's Disaster Assistance Support Program (DASP) is managed with funds and direction provided by the U.S. Agency for International Development/Bureau for Democracy, Conflict, and Humanitarian Assistance/Office of U.S. Foreign Disaster Assistance under Participating Agency Service Agreement: DCH-P-00-03-00002.

OFDA
September 2005

POLICY GUIDELINES

The U.S. Agency for International Development (USAID)/Bureau for Democracy, Conflict, and Humanitarian Assistance/Office of U.S. Foreign Disaster Assistance (OFDA) has the responsibility to provide foreign disaster assistance and to coordinate the response of the U.S. Government (USG) to disasters abroad. The authority to provide and coordinate USG foreign disaster assistance originates with the Foreign Assistance Act (FAA) of 1961, as amended. OFDA's mandate is to save lives, alleviate suffering, and reduce the economic impact of disasters. OFDA does so by:

- Providing rapid, appropriate response to requests for assistance.
- Providing sufficient warning of natural events that cause disasters.
- Fostering self-sufficiency among disaster-prone nations by helping them achieve some measure of preparedness.
- Enhancing recovery from disasters through rehabilitation programs.

OFDA carries out these responsibilities in coordination with the government of the affected country, other donor governments, international organizations, United Nations (UN) relief agencies, and private voluntary and nongovernmental organizations. The primary responsibility for disaster relief rests with the government of the affected country. OFDA responds only when the U.S. Ambassador or Chief of Mission in an affected country has declared a disaster based on the following criteria:

- The magnitude of the disaster exceeds the affected country's capacity to respond.
- The affected country has requested or will accept USG assistance.
- It is in the interest of the USG to provide assistance.

OFDA's assistance is intended to supplement and support, not replace, the response, preparedness, and mitigation efforts of the government of the affected country. It is the responsibility of

the U.S. Chief of Mission to ensure that USG assistance is appropriate and based on priority humanitarian needs. To ensure that the response is appropriate, timely, and cost effective, OFDA provides technical assistance through damage and needs assessments. That initial technical assistance may come in the form of an OFDA Assessment Team whose objectives are to:

- **Assess** the scope of the disaster's damage.
- **Assess** the initial needs of victims.
- **Report** to the Chief of Mission and OFDA headquarters in Washington, DC (OFDA/W) on the situation and needs.
- **Recommend** followup USG relief actions, if any.

Assessment Team findings and recommendations must be clear, concise, timely, practical, and operational. They become the basis for USG decisionmaking and planning for disaster response activities.

Disaster relief that OFDA furnishes may include relief commodities, services, transportation support, grants to relief organizations, technical assistance, or any combination thereof.

If a large-scale, urgent, and/or extended response is necessary, OFDA will deploy a Disaster Assistance Response Team (DART), which provides specialists trained in a variety of disaster relief skills to assist the U.S. Chief of Mission and the USAID Mission (where present) with the management of the USG response to a disaster. As with an Assessment Team, DARTs continue to assess and report on the disaster situation and recommend followup actions. In addition, DARTs can:

- **Establish** an operational presence on the ground capable of carrying out sustained response activities.
- **Develop and, upon approval, implement** OFDA's field response strategy based on the DART mission objectives.
- **Coordinate** the movement and consignment of USG relief commodities.

- **Coordinate** USG relief efforts with the affected country, other donor countries, relief organizations, and, when present, military organizations.
- **Fund** relief organizations (when delegated the funding authority).
- **Monitor and evaluate** USG-funded relief activities.

The Team Leader reports to the U.S. Chief of Mission or his or her designee as the lead USG person in the affected country to ensure that USG disaster relief efforts are coordinated and to OFDA/W to ensure that OFDA's mandate and mission are being carried out effectively and efficiently.

To provide the necessary support to a DART, the OFDA Director may decide to activate an OFDA/W Response Management Team (RMT). The OFDA Director, through the RMT, coordinates the USG response to a disaster from OFDA/W. The RMT serves as the primary liaison between field disaster response and OFDA/W. When the RMT is activated and in place, responsibility for decisionmaking and coordination and primary point of contact for DART(s) or other resources deployed in the field moves from the Regional Team to the RMT until these responsibilities are returned to the OFDA Director. The chief purpose of the RMT is to represent USAID, oversee Washington-based support, provide interagency coordination of the relief activities, and support DART field operations. On occasion, more than one deployed DART may be supported by the RMT.

OFDA considers long-term recovery and development activities when providing disaster relief to victims in the immediate aftermath of a disaster. Disasters can provide the opportunity to reduce the vulnerability of the affected country to future disasters. Rehabilitation and reconstruction, properly formulated, can do much to introduce mitigation techniques to protect against the effects of future disasters.

OFDA stands ready to continue the American tradition of providing humanitarian relief to disaster victims worldwide.

Chapter I

General Responsibilities and Information

GENERAL RESPONSIBILITIES AND INFORMATION

This chapter provides information on general responsibilities for individuals sent to disaster sites to perform assessments or to participate as members of a Disaster Assistance Response Team (DART). Lists of needed equipment and supplies are also included.

A. Individual Team Member Checklist

The following pages contain five types of checklists for team members:

- Personal items.
- Optional items.
- Personal health items and medical tips.
- OFDA-provided items.
- Information to be left with Office of U.S. Foreign Disaster Assistance (OFDA) headquarters in Washington (OFDA/W).

Team members should be as individually mobile as possible. Unless you are deploying as a member of a long-term DART, try to limit your personal belongings to what you can carry.

1. Personal Items and Related Tips

- [] Valid passport. Make two copies of the front two pages—provide one copy to OFDA's Operations Division, Overseas Administration Team and keep the other copy with your travel authorization (TA).
- [] Visa(s), if required.
- [] International Certificate of Vaccination (also called "Yellow Book"), including:
 - [] Immunization record.
 - [] Prescription for eyeglasses or contact lenses, if applicable.
 - [] Blood type.Make a copy of your Yellow Book and keep the copy separate from the original, in case you lose the original.
- [] Personal health items (see "Personal Health Items and Medical Tips," below).
- [] Adequate amount of U.S. currency/traveler's checks (check to see if you will be able to cash them) for length of assignment.
- [] Personal checks and major credit cards.
- [] First aid kit (a basic kit is provided in field packs and remote location kits).

- Food for 36 hours (high energy, low weight).
- Drinking water for 36 hours (2-3 liters).
- Four changes of clothing appropriate for the location, climate, time of year, and kind of assignment.
- Toiletries.
- Six extra passport photos.
- Flashlight with spare batteries.
- Alarm clock.
- Pocketknife.
- Earplugs.
- Business cards.

2. Optional Items (Bring at Your Own Risk)

- Camera with film and batteries.
- Pocket-sized binoculars.
- Electrical adapters for appliances.
- Pocket calculator.
- Travel-style cup or mug.
- Swapping items (pins, buttons, pencils, stickers, etc.).

3. Personal Health Items and Medical Tips

- Prescription medicine for expected length of stay.
- Medication for colds, allergies, diarrhea, athlete's foot, menstrual cramps, hemorrhoids, constipation, and headaches.
- Nonsterile gloves (for your protection if you provide first aid to others).
- Sunscreen (SPF 15 or higher).
- Insect repellent.
- Antiseptic ointment.
- Lip balm.
- Vitamins.
- Small scissors.
- Tweezers.
- Soap.
- Small bottle or individual swabs of isopropyl alcohol.
- Water purification tablets or system.
- One packet of oral rehydration salts.
- Baseball cap or hat for sun and rain.
- Flip-flops.
- Extra pair of eyeglasses or contacts (be aware of dusty conditions at disaster sites).

Don't take any toiletries or first aid kit items in glass bottles.

4. OFDA-Provided Items

- [] *Field Operations Guide (FOG) for Disaster Assessment and Response.*
- [] Personal first aid guide, available through the Operations Division. (A guide is not a substitute for First Aid training, which is regularly offered through OFDA's Training Unit.)
- [] Position description and checklist pertaining to your assignment (see FOG Chapter IV).
- [] Embassy country clearance(s) for travel to the affected country.
- [] Short-term immunizations, boosters, and malaria pills needed at time of departure (contractors: check when negotiating contract).
- [] TA (make an extra copy), travel advance, and airline tickets if travel is under OFDA. Make sure TA covers your potential needs such as car rental, local ticket purchase, or excess baggage.
- [] OFDA Field Pack or Remote Location Kit (if needed). DART members will usually be issued one of these kits by the OFDA Logistics Officer, if requested. The contents of the kits are listed in Appendix B, "OFDA Stockpile Commodities and DART Support Equipment."
- [] Overseas workmen's compensation and medical evacuation insurance. Compensation and insurance are provided only for contractors.
- [] Laptop computer.
- [] Communications equipment.
- [] Global Positioning System (GPS).

5. Information To Be Left With OFDA/W

- [] Personal information sheet for personal and family emergencies.
- [] Copy of passport picture page, visa(s), and immunization record.

B. Team Support Checklist

This checklist addresses overall team needs and complements the Individual Team Member Checklist in section A and the position checklists in Chapter IV, "Disaster Assistance Response Team." The Team Leader ensures that the following team support items are acquired before deployment.

- [] Contact list for U.S. Agency for International Development (USAID) and U.S. Embassy, private voluntary organizations

- (PVOs), nongovernmental organizations (NGOs), international organizations (IOs), United Nations (UN) agencies, donor and assisting countries, and appropriate affected-country officials.
- [] Current copy of the Mission Disaster Relief Plan (MDRP) for the affected country. The MDRP, which is part of the Embassy's Emergency Action Plan (EAP), is available through OFDA's Operations Division.
 - [] USAID decals and stickers.
 - [] Camera and film or camcorder (optional).
 - [] Telecommunications equipment commensurate with the assignment.
 - [] Copies of reference documents pertaining to affected country (if available):
 - [] Country profile information.
 - [] State Department background notes.
 - [] Lessons learned or relevant After Action reports.
 - [] Maps covering the affected and surrounding areas.
 - [] OFDA's Disaster History and Commodity Services Report.
 - [] Travel advisory alerts.
 - [] Public health bulletins.
 - [] List of cultural *do's* and *don'ts*.
 - [] Assessment guides.
 - [] Copy of all cable traffic pertaining to the disaster.
 - [] Copy of all directives and team support documents:
 - [] OFDA's team support funding documents.
 - [] Overseas workmen's compensation and medical evacuation insurance for contractors.
 - [] TAs and itineraries.
 - [] Special authorizations and instructions from OFDA Director.
 - [] Photocopy of passports, visa, and personal information sheet.
 - [] OFDA Office Supply Kit.
 - [] Remote location first aid manual, such as "*Where There is No Doctor: A Village Health Care Handbook*" by David Werner et al. published May 1992.

C. Documentation

1. General

Team Leaders may make team members responsible for maintaining a daily log of activities with which they are involved. This log should include a chronology of significant events (departures,

arrivals, meetings attended, individuals contacted, work accomplished, etc.). The log should be turned in to supervisors on request. The log is then turned in to the Planning function, where it becomes a part of the disaster response documentation and may also be used in the development of situation reports.

2. Types of Documentation

Each DART function receives and develops information that becomes a part of the disaster response documentation. The following list includes the types of documentation generated by each function.

Management. Delegation of authority from OFDA/W, disaster relief objectives, press releases, safety and security plans, and liaison plans.

Planning. Situation reports, disaster chronology (developed from individual logs and information gathered by Planning), maps, assessments, daily plans, personnel tracking, and grant status.

Logistics. Equipment and commodities tracking, accountability documents, and equipment use information.

Operations. Work assignments, work accomplishments, assessments, and maps.

Administration. Fiscal accounting, rental and procurement agreements, receipts, personnel records, and petty cash records.

Communications. Communications plan, radio protocols, radio logs, and communications equipment information.

D. Accountability and Liability

1. Equipment

Team members are responsible for three types of equipment and supplies at a disaster: expendable, nonexpendable, and personal.

Expendable. Those items that are issued for use at a disaster site and are used up, consumed, or possibly left at the disaster site for use by victims or local individuals involved in continuing

disaster relief efforts. Expendable items include office supplies, gloves, small water containers, plastic sheeting, blankets, tents, hardhats, and hand tools. When issuing expendable items to local relief workers, be sure that the items are needed for the immediate relief effort. Some expendable items have proven to be personally attractive and particularly susceptible to being used for purposes other than relief activity.

Nonexpendable. Those items issued for use at a disaster and can be returned and refurbished for use on future assignments. Nonexpendable items include vehicles, radios, generators, specialized tools, and computers.

Personal. Those items, such as clothing, toiletries, extra glasses, and medications that an individual takes to a disaster to attend to his or her personal needs. Cameras, binoculars, shortwave radios, and such items are considered personal items unless specifically required or provided by OFDA.

2. Accountability

If OFDA deploys a DART or an Assessment Team to assist the USAID Mission or U.S. Embassy (USAID/Embassy) in the affected country, OFDA will become accountable at the field level for the distribution of all funds, supplies, equipment, and commodities used in disaster relief operations. Team members have the responsibility to account for all items they consume, use, damage, destroy, or lose. This accounting must be done through a documentation system that tracks receipt and disposition. Team members should always receive and keep an inventory of items for which they are responsible. Supervisors are responsible for identifying the method and level of tracking necessary for each disaster based on direction from the Team Leader. Lost or damaged items must be accounted for with a written statement explaining the circumstances. When a question arises over whether an item is expendable, the Team Leader is responsible for making the decision. Certain disaster situations may call for issuing nonexpendable items to local agencies for use beyond the deployment of the team. Such issues should be documented through a memorandum of understanding (MOU) signed by both parties, becoming part of the team documentation. The Team Leader has the final team authority to decide what will or will not be left.

If OFDA does not deploy a DART or Assessment Team, the accountability for funds or relief supplies, materials, and equipment provided by OFDA rests primarily with the recipient USAID Mission in the affected country.

3. Liability

Team members are liable for items lost or destroyed through poor accounting or performance. Problems arising from poor accounting or performance will be resolved with the appropriate representatives of the member's parent agency. Applicable USAID regulations will be used during the resolution.

E. Administration

1. Time Records

Depending on the relationship with OFDA, team members may or may not need to keep track of hours worked during a deployment to a disaster. OFDA will determine what method of timekeeping is necessary. If there will be reimbursement for all or a portion of a person's time, the team member must make sure that he or she and his or her agency are clear on what method of reimbursement will be used by OFDA. Team members may be serving OFDA under the following types of agreements.

USAID Direct Hire. See USAID Directives and discuss with your supervisor.

Personal Services Contractor. Reimbursement and reporting documentation determined by contract. Check with OFDA at time of contract issuance.

Interagency Agreement. DART leader establishes the work schedule. Reimbursement for overtime, comp time, and other types of compensation shall be in accordance with the parent agency's personnel policies.

Individual Working for an Institutional Contractor, Grantee, or an Organization With a Memorandum of Understanding With OFDA (May Include Volunteers). Reimbursement and reporting documentation are determined by the contract, grant, or MOU. Parent agencies must determine the required documentation.

2. Per Diem and Vouchers

Current per diem rates and normal per diem rules will be used by all team members to determine amounts to be reimbursed for expenses incurred during a team deployment.

Team members will fill out travel vouchers with the agency that prepares their TAs. If a team member will be reimbursed based on actual lodging expenses, he or she must obtain receipts for lodging and will have to provide a justification if the charges are in excess of per diem rates. Remember, only those expenses authorized on a travel authorization and documented with receipts can be reimbursed.

3. Procurement and Contracting

Unless authorized, team members cannot purchase, hire, or contract for goods and services or make informal commitments to do so. If team members have any questions as to the limits of their procurement or contract authority, they should contact their team leader or the Administrative Officer.

F. Safety and Security

The safety and security of everyone on the team is a responsibility of every team member, regardless of his or her position on the team. The goal is to prevent accidents and injuries, avoid situations that compromise personal security, and protect the safety and health of all team members on and off the job. When a team member becomes sick, injured, or involved in a security incident and must be cared for, rescued, and possibly evacuated, the team's ability to deliver the maximum assistance possible to those affected by the disaster is diminished.

THINK SAFETY AND SECURITY AT ALL TIMES!

The following checklist for safety and security covers some of the general issues team members should be aware of before they depart and throughout their deployment. If a written Safety and Security Plan is available, team members should obtain a copy. Team members should get briefings before they leave on the safety and security situation in the disaster area and stay current on these issues when deployed. If the team has a Safety/Security Officer, team members should get briefings and a copy of the Safety and Security Plan from this team member.

1. Safety and Security Checklist

- WEAR YOUR SEAT BELT—ALWAYS! Vehicle accidents are often the greatest potential risk to team members during a deployment. Drive safely and be aware of local driving hazards; if you have drivers, insist that they maintain safe speeds.
- Keep informed about safety and security issues throughout your assignment.
- Maintain regular communication with the team.
- Learn and adhere to security and safety standards, protocols, and procedures.
- Be aware of personal safety/security hazards or concerns, including:
 - Signs of danger (culturally, politically).
 - Areas of danger (crowds, mined areas, factional borders).
 - Physical danger (increase in criminal activity, increase in factional fighting, shelling, shooting).
- Be knowledgeable of the communications portion of the Safety and Security Plan, including:
 - Frequencies in use by team and others (UN/PVOs/NGOs/IOs or donors).
 - Contact/call-in protocols among team members and with USAID/Embassy.
 - Secondary backup systems and protocols.
 - Radio procedures.
 - Copies of frequencies, procedures, etc., available in the office and vehicles.
- When traveling, get briefings and prepare a travel plan following the Safety and Security Plan protocols, which include:
 - Briefings on road and security conditions.
 - Routes to be driven.
 - Check-in points and procedures.
 - Planned stops.
 - Points of contact at stops.
 - Timeframe for trip.
 - A list of items taken for safety or security reasons (personal gear, extra food or water, vehicle equipment spares, security items, etc.).
 - At the conclusion of the travel, close out travel plan and debrief the Safety and Security Officer or Team Leader on the road and security conditions.

- Be knowledgeable of the Security Evacuation Plan located in the Safety and Security Plan, which should include:
 - Coordination and communication systems and protocols with team, Embassy/Mission, and possibly U.S. military.
 - Shutdown procedures (collection or destruction of sensitive materials and equipment).
 - Location of secure assembly points with stay-or-go procedures.
 - Survival equipment and supplies, and potential need for protective clothing (amount, location, access).
 - List of personal items to take or leave in an emergency and location of those items.
 - Transportation methods for evacuation (road, air, water).
 - Evacuation routes (airport, border, specific road) marked on maps.
 - Vehicles equipped and prepared for evacuation.
 - Plan rehearsed or discussed and each team member's role defined.
- Be knowledgeable of the Medical Emergency Plan located in the Safety and Security Plan, which provides the following:
 - Location and methods to contact medical facilities.
 - Points of contact and methods for notification of the situation.
 - Transportation/evacuation plan for victim(s), including ground and/or air.
- Share the Safety and Security Plan with cooperators, as appropriate, and seek to obtain their plans.
- Understand notification procedures for serious incidents (e.g., injuries, deaths, kidnappings).
- Report hazardous conditions and other safety/security concerns to your supervisor and also to the Safety/Security Officer, if one is on the team.
- Find out about fire detection and protection procedures in lodgings; check for exits.

G. Personal Health and Critical-Incident Stress

This section provides a guide to recognizing and meeting common physical and emotional problems encountered during disaster relief activities. Experience has shown that promoting and maintaining good health, especially by coping with the stresses encountered overseas, are the keys to successful performance.

1. Briefings

The most important key to personal health and safety is to follow briefings given by OFDA, the State Department, the DART Team Leader, the USAID Mission in-country, the U.S. Embassy or Consulate in-country, and affected-country contacts. They can provide up-to-date details on disease, sanitation, food and water safety, personal and property security, and other information to keep team members healthy and safe during the assignment.

Team members should never knowingly put their lives in jeopardy. “Stay alert, keep calm, think clearly, and act decisively” should be their motto. Tasks should be accomplished by putting safety first.

2. Managing Culture Shock

Team members may experience two different but related types of stress. The first is culture shock, which comes from suddenly being placed in a foreign environment. The second is the emotional and physical impact that often comes from being immersed in a disaster.

Between arriving in-country and reaching the disaster site, team members may experience classic culture shock. The team member is a foreigner and may be frustrated because of an inability to communicate with the local population; anxiety and frustration may erode his or her customary level of self-confidence.

The team member should expect to be disoriented and confused and realize that this response is natural and often happens to others in similar situations. Patience, realistic expectations of an ability to make a difference, and a sense of humor are good coping strategies in these circumstances. The team member should not expect the affected country and the victims to change their ways of doing things to accommodate relief workers.

3. Critical-Incident Stress

No one who sees a major disaster remains emotionally untouched by it. Typical reactions are feelings of frustration, hopelessness, that simply too much suffering exists, and one person can have relatively little impact.

The combined effects of cultural stress and job stress make team members vulnerable to physical and emotional exhaustion. Some people refer to this condition as “burnout.” It can happen to anyone.

The disaster-related stress caused by these factors is often referred to as critical-incident stress (CIS). A critical incident is any incident so unusually stressful to an individual as to cause an immediate or delayed emotional reaction that surpasses available coping mechanisms. Critical incidents take many forms, including all emergencies that cause personnel to experience unusually strong reactions.

The effects of critical incidents can include profound behavioral changes that may occur immediately or may be delayed for months or years.

4. How Team Members May Be Affected by Stress During Disaster Operations

Following are some ways team members may be affected by stress during disaster operations.

- They may experience physical symptoms associated with stress, such as headache, upset stomach, diarrhea, poor concentration, and feelings of irritability and restlessness.
- They may become overwhelmed by the disaster and prefer not to talk about it, think about it, or even associate with coworkers during time off. They may become tired of continual interaction with victims and may want to isolate themselves during time off.
- They may have feelings of frustration or guilt because they miss their families and are unavailable to their families physically and emotionally due to fatigue, their involvement in the disaster, and so forth.
- They may feel frustrated with family and friends when they are able to contact them because the relief workers feel that families and friends simply cannot understand the disaster experience. If family and friends become irritated, it can compound the problem, and temporary isolation and estrangement may occur.

5. How To Minimize Stress During a Disaster Operation

Following are some ways to minimize stress during a disaster operation.

- As much as possible, make living accommodations personal and comfortable. Mementos from home may help disaster workers to keep in touch psychologically.
- Exercise regularly consistent with your present physical condition and the limitations of the disaster site and try to relax with some activity away from the disaster scene.
- Get enough sleep and try to eat regular meals, even if you are not hungry. Avoid foods high in sugar, fat, and sodium. Taking vitamin and mineral supplements may help your body to continue to get the nutrients it needs.
- Avoid excessive use of alcohol and coffee. Caffeine is a stimulant and should be used in moderation because it affects the nervous system, making relief workers nervous and edgy.
- Although you need time alone on long disaster operations, spend time with coworkers. Both experienced and new relief workers should spend rest time away from the disaster scene. Talking about normal things (home, friends, family, hobbies, etc.) other than the disaster is a healthy change of pace.
- Use humor to help ease the tension. Use it carefully, however, as victims or coworkers can take things personally, resulting in hurt feelings if they are the brunt of “disaster humor.”
- When on the job, take breaks during the day, especially if you find yourself making mistakes or are unable to concentrate.

Team members should try to stay in touch with family back home if they can. Communication helps prevent the sense of being strangers when they return after the disaster.

Team Leaders can take specific, practical action to prevent and reduce the effects of CIS, consequently avoiding the personal and organizational costs associated with treatment. Steps include:

- Learning to identify and respond to CIS in personnel.
- Educating team members in advance about the potential harmful effects of critical incidents.

Experiencing stress during a disaster operation is normal, but remember that stress can be identified and managed.



Chapter II

Assessments

ASSESSMENTS

A. Introduction

The purpose of this chapter is to provide Office of U.S. Foreign Disaster Assistance (OFDA) staff and others who participate on OFDA Assessment Teams with a guide to conducting an initial assessment for sudden or slow onset disasters. It includes information on the purpose, types, and elements of an assessment; collecting and analyzing data; preparing recommendations for U.S. Government (USG) response; and submitting assessment reports to OFDA Washington (OFDA/W). It also provides basic assessment checklists by sector.

In addition to providing a guide to conducting an initial assessment, this chapter identifies broad categories of information to gather for specific sectors. The *Field Operations Guide* (FOG), however, is not intended as a complete reference for comprehensive assessments conducted by sector experts. When sector experts—epidemiologists and water/sanitation specialists, for example—are deployed as members of an Assessment Team, they provide additional assessment methods and tools to undertake a comprehensive sector analysis.

B. Purpose of an Initial Assessment

The overall purpose of an initial assessment is to provide OFDA/W and the USG with information, analyses, and recommendations to make timely decisions on a USG disaster response. Initial assessments:

- Identify the impact a disaster has had on a society, and the ability of that society to cope.
- Identify the most vulnerable populations (often likely to be women, children, and the elderly) that need to be targeted for assistance.
- Identify the most urgent food and nonfood requirements and potential methods of providing these in the most effective and equitable manner.
- Identify the level of response by the affected country and its internal capacities to cope with the situation, especially direct assistance to the affected population(s).

- Identify the priorities of the affected population(s) and their preferred strategies for meeting those priorities.
- Identify the level of response from other donor countries, United Nations (UN) relief organizations, private voluntary organizations (PVOs), nongovernmental organizations (NGOs), and international organizations (IOs).
- Make recommendations to OFDA/W and U.S. Embassy and/or U.S. Agency for International Development (USAID) Mission (if present) that identify and prioritize the actions and resources needed for immediate response. Recommendations should include possibilities for facilitating and expediting recovery and development, and supporting prevention and mitigation.
- Identify which types of indepth assessments should be undertaken.
- Highlight special concerns that would not be immediately evident to OFDA/W or to individuals not trained in emergency response.

Initial assessments should also provide baseline data that can be used as a reference for further monitoring. Monitoring systems should be put in place to enable relief officials to determine whether a situation is improving or deteriorating. These systems must include ways to measure the efficiency and effectiveness of relief activities. Each assessment or survey should be designed to build on previous survey findings and expand the data base.

The Assessment Team must be sensitive to the situation of the affected country. The team needs to structure its assessment questions so that unreasonable expectations are not created. It should be clear to the affected country what the United States can/cannot and will/will not do. The Assessment Team must also be aware of the pressures applied by the affected country and others to “identify needs.” A recommendation of “no additional assistance is required” may be valid if an on-the-ground site visit finds a disaster that is not as severe as indicated in third-hand reports and media coverage (focused on a few dire cases) received in Washington before the Assessment Team’s departure.

Remember that the Assessment Team is supporting the U.S. Country Team led by the Ambassador. The Country Team will have a strong desire to help. The Assessment Team must consider the Country Team’s willingness to assist, but it also must be prepared to advise it on the parameters and limitations of OFDA support.

OFDA Assessment Team findings and recommendations must be clear and concise, because they become the basis for USG decisionmaking and planning for the disaster response. Precise assessments are the foundation of OFDA's work.

C. Assessment Team Composition

The decision to deploy an Assessment Team rests with the Director of OFDA. The composition of an Assessment Team will be determined by the Director in consultation with OFDA's Senior Management Team (SMT). An ideal OFDA Assessment Team typically comprises specialists with expertise needed for the disaster in fields such as health, nutrition, water and sanitation, engineering, logistics, communications, disaster management, and OFDA policies and procedures. The specialists also should have had training in areas such as gender sensitivity, cultural appropriateness, and livelihood rehabilitation. OFDA draws experts from within OFDA and USAID, other Federal agencies, contractors with disaster management experience, donor government aid agencies, and the UN/PVO/NGO/IO community.

The Assessment Team is led by a Team Leader who is usually selected from within OFDA or USAID. Team Leaders are familiar with OFDA's mandate and response capabilities. The specific scope of work for each Assessment Team is defined by OFDA management and the USAID/Embassy in the affected country.

D. Assessment Recommendations and Their Impact on Recovery

Recommendations made by the Assessment Team must not have a detrimental effect on the long-term recovery efforts of an affected country. Relief programs can set the stage for rapid recovery or prolong the length of the recovery period. Every action in an emergency response will have a direct effect on the manner and cost of reconstruction.

Many standard relief programs can create dependencies and severely reduce the survivors' ability to cope with the next disaster. For example, food commodities brought into a disaster area without consideration for the local agricultural system can destroy the local market system and cause future food shortages where self-sufficiency had been the norm. Another example is when

the relief supplies, equipment, or technology provided cannot be sustained in the socioeconomic environment of the affected population. When these relief efforts conclude, the survivors may be left in the same condition or worse than immediately following the disaster.

Sustainable recovery depends on restoring the affected populations' own capacity to meet their basic food, health, shelter, water, and sanitation needs. The victims have the most immediate and direct interest in recovering from a disaster, and most disaster survivors do so using their own resources. Consequently, they may place a high priority on restoring their means of livelihood. Understanding their priorities and providing assistance that supports the affected population's efforts to restore viable socioeconomic systems are critical to achieving a long-lasting, sustainable recovery.

Recommendations should be simple, support the use of local materials and systems, and be sustainable by the affected country. Do not discount alternative interventions that may be against "conventional wisdom," collide with bureaucratic obstacles, or require increased relief agency capacity. In the long run, they may be more cost effective and sustainable.

E. Keys to a Successful Assessment

Several factors contribute to the design of a successful and accurate assessment.

1. Identify the Users

Every element of an assessment should be designed to collect information for a specific user. The potential users should specify their information needs during the design phase. For example, health workers need certain types of information that will only be useful in certain formats—usually tables—while a procurement officer may need other types of quantitative or qualitative data.

2. Identify the Information Needed To Plan Specific Programs

Too often, assessments collect information that is incomplete or of little value for planning relief programs or specific interventions. In many cases, information is anecdotal rather than substantive; in others, valuable time is wasted collecting detailed information when the identification of broader trends would be just as useful.

Determine what information is vital, what method is best to obtain this information, and how much detail is necessary for the information to be useful. The type of assistance provided by an agency should be considered when determining the types of data to be collected. For example, an agency that provides food will need to know about availability of transport and fuel, road conditions, local crop harvests, etc.

3. Consider the Format

It is important to collect, organize, and present the data in a form useful to analysts and program planners. The results must be succinct and presented in a format that makes the implications or recommendations very clear so that priorities can be set quickly. By applying baselines and standards to the presentation, key relationships can be quickly noted. For example, daily death rates in a displaced person (DP) camp should be calculated and compared to the international standard of 1.0 deaths per 10,000 people per day.

4. Consider the Timing of the Assessment

Timing may affect the accuracy of an assessment because situations and needs can change dramatically from day to day. Various types of assessments need to be timed to collect the necessary information when it is available and most useful. Relief needs are always relative but, as a general rule, initial surveys should be broad in scope and should determine overall patterns and trends. More detailed information can wait until emergency operations are well established.

5. Determine the Best Places To Obtain Accurate Information

If the information must be obtained from sample surveys, ensure that the areas to be surveyed represent an accurate picture of needs and priorities. For example, carrying out a health survey limited to a medical center would yield a distorted view of the overall health situation because generally only sick or severely malnourished people and their relatives would be in the medical center.

6. Distinguish Between Emergency and Chronic Needs

Virtually all developing countries have longstanding chronic needs in most, if not all, sectors. It is important to design an

assessment that distinguishes between chronic and emergency needs. Attempt to acquire baseline data, reference data, and/or recognized and accepted standards in each sector. For example, if malnutrition is prevalent in a certain area of a country, a nutrition survey of the affected population will almost certainly reflect poor nutritional status. The surveyors must differentiate between what is normal for the location and what is occurring as a result of the disaster so that emergency food aid and health care can be provided to those in most dire need. (Remember that assessments may bring to light previously unrecognized or unacknowledged problems in a society. Thus, the data collection system should be careful to structure the information so that critical data such as health status, etc., can be used for long-term planning.)

7. Assess Needs and Vulnerabilities in Relation to Capacities

Needs are immediate requirements for survival. Vulnerabilities are potential areas for harm and include factors that increase the risks to the affected population. Vulnerabilities create unequal levels of risk between groups. Needs are assessed after an emergency has occurred, whereas vulnerabilities can be assessed before and during the emergency. Needs are expressed in terms of requirements (food, water, shelter, etc.); vulnerabilities are expressed in terms of their origins (physical/material, social/organizational, or motivational/attitudinal). The antidote to needs and vulnerabilities are self-reliance and capacities. Capacities are means and resources that can be mobilized by the affected population to meet their own needs and reduce vulnerability. Assessing vulnerabilities and capacities, as well as needs, provides the following benefits:

- Preventing an expansion of the emergency in which today's vulnerabilities become tomorrow's needs.
- Targeting assistance to the most vulnerable groups.
- Effecting a sustainable recovery based on local resources and institutions.

The last point is particularly important because externally derived assistance can actually slow recovery and impede a return to development if not provided in a way that supports the efforts of the local populations to secure their own means of long-term survival. The direct engagement of members of the affected population is essential to ensure an accurate and thorough assessment of their needs, vulnerabilities, and capacities.

8. Use Recognized Terminology, Standards, and Procedures

Assessments will invariably be carried out by a variety of people operating independently. To provide a basis for evaluating the information, generally accepted terminology, ratings, and classifications should be used in reporting. The use of standard survey forms with clear guidelines for descriptive terms is usually the best way to ensure that all information is reported on a uniform basis.

F. Types of Assessments

OFDA Assessment Teams typically collect two types of information: (1) what has happened as a result of the disaster, and (2) what is needed to save lives, alleviate suffering, and mitigate negative economic impacts. The type of information that is usually first available to an Assessment Team concerns the effects of the disaster. The process of collecting this information is referred to as a situation or disaster assessment. It identifies the magnitude and extent of the disaster and its effects on local populations. The second major type of information-gathering is a needs assessment, which defines the level and type of assistance required for the affected population. The gathering of information for the situation assessment and needs assessment can be done concurrently. The information collected in the initial assessment(s) is the basis for determining the type and amount of relief needed during the immediate response phase of the disaster. It may also identify the need to continue monitoring and reassessing the unfolding disaster situation.

A third type of assessment is sometimes undertaken when proposing to fund relief activities. USAID policy requires the assessment of possible negative impacts on the environment of any major expenditure of funds. OFDA-funded assistance is exempted from a formal environmental impact review if the assistance is needed immediately to save lives or livelihoods. Annex H, “Principles of Context-Specific Programming” in OFDA’s *Guidelines for Proposals and Reporting*, however, does ask for a discussion of the environmental impacts of proposed assistance when possible.

1. Situation (Disaster) Assessment

This assessment gathers information on the magnitude of the disaster and the extent of its impact on the population and the

physical infrastructure, as well as the environment. The following areas should be assessed and reported:

- Area affected by the disaster (location and size).
- Number of people affected by the disaster.
- Mortality and morbidity rates.
- Types of injuries and illness.
- Characteristics and condition of the affected population.
- Groups within the population that may be disproportionately affected or require special attention.
- Emergency medical, health, nutritional, water, and sanitation situation.
- Level of continuing or emerging threats (natural/human-caused).
- Damage to infrastructure and critical facilities.
- Damage to homes and commercial buildings.
- Damage to agriculture and food supply system.
- Damage to economic resources and social organization.
- Vulnerability of the population to continuing or expanding impacts of the disaster over the coming weeks and months, and whether vulnerability varies among different groups.
- Level of response by the affected country and internal capacities to cope with the situation.
- Potential constraints or roadblocks to assistance efforts.
- Level and nature of ongoing or anticipated response from other donor countries and PVOs/NGOs/IOs.

2. Needs Assessment

The initial needs assessment identifies resources and services for immediate emergency measures to save and sustain the lives and livelihoods of the affected population. Conduct this assessment at the site of a disaster or at the location(s) of displaced population(s). A rapid response based on this information should help lower excessive death rates and stabilize the nutritional, health, and living conditions among the population at risk. A rapid response to urgent needs must never be delayed because a comprehensive assessment has not yet been completed.

Areas assessed and reported on, which are closely linked to the information gathered in the above situation assessment, include:

- Priority and magnitude of response in each sector.
- Type, duration, methods, and location(s) of assistance in each sector.
- Degree and nature of potential local participation in the response.

3. Environmental Impact Assessment

The need to consider environmental issues during disaster operations rests on four considerations:

- Environmental degradation often causes natural disasters and aggravates their effects.
- Competition over natural resources frequently provokes armed conflicts.
- Disasters can result in significant environmental damage.
- Relief assistance can result in negative environmental impacts, leading to a need for additional assistance to solve problems that could have been avoided or at least mitigated if they had been anticipated in the disaster response planning stages.

In other words, failing to consider the natural environment and the management of natural resources during the planning and execution of relief operations can lead to unanticipated problems and reduce the effectiveness of the overall assistance effort.

To help assess disaster-environment linkages, various organizations have developed methods and tools for rapid environmental assessments. These tools have been designed for rapid implementation either alone or as part of another assessment. They include relief organization and community inputs, making for a well-rounded assessment.

The results of rapid environmental assessments can be used to derive a prioritized list of salient environmental issues. These can be used to revise project proposals or ongoing projects or as input into relief and recovery planning.

Rapid environmental assessments can be used:

- During contingency planning.
- In the initial stages of a disaster.
- As the disaster evolves.
- As a screening tool to ensure negative environmental impacts are not missed in emergency proposals.

Environmental assessments can be applied to any response activity, but are probably more cost effective for projects of sub-activities exceeding \$50,000. Environmental assessments are best undertaken using a team approach—ideally a coalition of relief organizations with community input—and looking at the overall disaster situation. However, they can be conducted by one person working alone, if necessary.

G. Elements of an Assessment

The information that follows defines the elements of any assessment. Assessments are generally composed of the six basic elements or activities described below.

1. Preparedness Planning

An accurate assessment depends on thorough planning, design, and preparation. Most information needs can be identified well in advance. The means of collecting the necessary data, and the selection of formats for collection and presentation of the information, should be established as part of an organization's predisaster planning. Seek advice widely from survey specialists, statisticians, and epidemiologists. By preparing to undertake assessments before a slow onset emergency reaches a crisis stage, the data required and the process most appropriate for its accurate and speedy collection can be identified and refined before undertaking a major response. Proper design of sampling and survey methods can increase substantially the accuracy and usefulness of assessment data. Standard survey techniques, questionnaires, checklists, and procedures should be designed to ensure that all areas are examined and that the information is reported using standard terminology and classifications. Also, consideration of local factors, social organization, and hierarchies of power at this stage can help greatly in formulating interview methods, identifying useful sources of information, and avoiding constraints to information gathering.

2. Survey and Data Collection

The gathering of the information must proceed rapidly and thoroughly. In an initial reconnaissance, surveyors should look for patterns and indicators of potential problems. Using the procedures developed earlier, key problem areas must be thoroughly checked. Identify sources of all information. Examples include whether the information was observed, reported by an informant in a discussion, collected through a survey of a randomly or purposively sampled population, heard by rumor, etc. The information will be more meaningful to those interpreting it—especially if reports conflict—if a source is indicated.

3. Interpretation

Thorough analysis of the information gathered is critical. Those performing the analysis must be trained to interpret the information, detect and recognize trends and indicators of problems, and link the information to specific courses of action.

4. Forecasting

Using the data that has been collected, the Assessment Team must gauge how the situation might develop in the future so that contingency plans can be drawn up that will help prepare for and mitigate potential negative impacts. Forecasting requires input from many specialists, in particular those who have had extensive experience in previous emergencies and who will be able to detect trends and provide insights as to what course an emergency might follow.

5. Reporting

When data analysis and forecasting are complete, reporting and disseminating the results in a format that enables managers to make decisions and formulate plans and projects is required. Essential information should be presented and structured so that the main patterns and trends are clear.

6. Monitoring

An assessment should not be seen as an end in itself, but rather as one part of a continuing process of reevaluating the needs and capacities of affected populations as well as the effectiveness and appropriateness of responses to the disaster situation. This is particularly true in long-term, complex humanitarian emergencies.

H. Data Collection

Distinguishing between the terms “data” and “information” is important and useful. Data is simply a collection of words, numbers, and other characters with a structure. Information is “useful or applicable data.” Data becomes information when it is useful, meaningful, relevant, and understandable to particular people at particular times and places and for particular purposes. What is information to one person can simply be useless data to another.

1. Data Collection Considerations

The following considerations are important in assessment data collection.

The Need for Accuracy. The information must agree with the reality it represents. The data on which it is based must be accurate and reliable.

The Need To Eliminate Bias. Consider the source of the data. Biases may be linked to the interviewer, respondent, recollection accuracy, time, seasons, culture, gender, and the instrument or measurement used for data collection. Biases may be minimized through triangulation, whereby a broad perspective is captured through inquiry among many stakeholders.

Ethical Considerations. Adhere to a high standard of ethics when soliciting data from stakeholders. Ethical practices include honesty and transparency, nonattribution, sensitivity to gender and cultural norms/taboo, and when possible, feedback on how the information provided was used.

The Need for Timeliness and Adequate Frequency. Information must be produced as and when needed. The frequency of data collection and reporting must match the rate of change in the situation being assessed.

The Question of Availability of and Access to Information. The way in which data is collected or the access to the data can affect the way the data is routed, who it reaches, and where its flow may be blocked.

2. Data Collection Methods

A range of data collection methods is available. The following list outlines some of the most common ways of collecting data in emergencies.

Automatic Initial Self-Assessment and Local Assessment by Key Elements in the System. For example, the staffs of “life-line” systems. This initial assessment can involve preplanned damage reporting by civil authorities and military units.

Visual Inspection and Interviews by Specialists. Methods can include flyovers, surveillance by special point-assessment teams (including preplanned visits), and sample surveys to achieve rapid appraisal of area damage.

Sample Surveying of Specific Characteristics of Affected Populations by Specialist Teams. Well-conducted surveys have a number of advantages, not least of which is the relative confidence that may be attached to data collected using formal statistical sampling methods. Several different types of sample surveys are available.

- **Simple random sampling.** Every member of the target population is equally likely to be selected, and the selection of a particular member of the target population has no effect on the other selections.
- **Systematic random sampling.** Every 5th or 10th member on a numbered list is chosen. Results may be inaccurate if the lists are structured in a biased manner).
- **Stratified random sampling.** The population is divided into categories (or strata); members from each category are then selected by simple or systematic random sampling and then combined to give an overall sample.
- **Cluster sampling.** The sample is restricted to a limited number of geographical areas, known as “clusters”; for each geographical area chosen, a sample is selected by simple or random sampling. Subsamples are then combined to get an overall sample.
- **“Sentinel” surveillance.** This method is used widely in emergency health monitoring, where professional staff establish a reporting system that detects early signs of particular problems at specific sites. The method can be applied to a

variety of other problems where early warning is particularly important.

- **Critical sector assessments by specialist.** This involves technical inspections and assessments by experts. This type of sampling is required in such sectors as health and nutrition, food, water supply, electric power, and other infrastructure systems. Critical sector assessments may be compiled from reports by specialists of these systems or by visits by external specialist teams.
- **Continuing surveillance by regular “polling” visits.** This method of systematic information-gathering visits to key sites is a technique that is well developed in epidemiological surveillance of casualty care requirements and emergent health problems.
- **Continuing surveillance by routine reporting.** As the situation develops, it will be especially useful if routine reporting systems can be adapted and used to develop a comprehensive picture of events.
- **Interviews with key informants.** These include interviews of those in government and PVOs/NGOs/IOs and within particular groups of affected people, local officials, local community leaders, and (especially in food and displacement emergencies) with leaders of groups of displaced people.

I. OFDA Assessment Cable Reporting Formats

The following cable format and content outlines should be used by OFDA Assessment Teams when sending reporting cables to OFDA/W following a disaster assessment. A longer, more detailed assessment report may be prepared by the team to address the points outlined in the cable in more depth.

1. Disaster Cable Format Considerations

- Always use Courier New, 12-point font.
- A cable line can not exceed 55 characters, including spaces.
- Do not use symbols (%,” , \$); instead, spell out percent, quote or end quote, and USD.
- When including editorial comments, preface and conclude these phrases with the designations note and end note or comment and end comment.

- Look at other cables from the Mission or other disasters for formatting help. See where other Embassy cables go. Copy addresses from incoming cables.
- Classification options:
 - Unclassified.
 - Sensitive, but Unclassified (SBU).
 - Confidential.
 - Secret.
 - Top Secret.
- Classification marker:
 - N/A for Unclassified and SBU cables.
 - For Classified cables, date should be listed at least 10 years in the future.
- Precedence options:
 - Routine.
 - Priority.
 - Immediate.
 - Niact Immediate.
 - Flash.
 - Critical.
- Types of tags:
 - Axxx = Administrative (ABUD = Budget).
 - Cxxx = Consular (CPAS = Passports) (CVIS = Visas).
 - Exxx = Economic (ELAB = Labor).
 - Pxxx = Political (PTER = Terrorism).
 - Oxxx, Sxxx = Public Diplomacy.
 - Geopolitical Tags (e.g., JA, NO, WA).

2. Who Should Get the Cable

At a minimum, the reporting cable should be addressed as follows:

SECSTATE WASHDC (for DCHA/OFDA, Regional Bureau, and DCHA/FFP also for the State Desk and PRM); INFO AMEMBASSY BRUSSELS (for USEC); AMEMBASSY ROME (Rome pass FODAG); USMISSION GENEVA (for USAID and RMA); USMISSION USUN NEW YORK; AMEMBASSY SAN JOSE (for OFDA Regional Advisor if the disaster is in Latin America); AMEMBASSY BANGKOK (for OFDA Regional Advisor if in Asia); AMEMBASSY NAIROBI, AMEMBASSY DAKAR, AMEMBASSY PRETORIA (for OFDA Regional Advisor if in Africa).

Additional INFO addressees will depend on the situation but could include:

- The neighboring country missions (e.g., if the affected country is Sudan, send also to Kenya, Addis Ababa, and Cairo at a minimum).
- Other European capitals with particular interests in the country (e.g., if the affected area is in Iraq, send also to Paris, London, and Berlin).
- SECDEF WASHDC.
- JOINT STAFF WASHDC.
- USCINCPAC-appropriate regional military addressee.
- NSC WASHDC.
- Others as situation requires.

3. Disaster Cable Contents

a. Subject

- Country.
- Type of Disaster.
- Assessment Topic.

b. References

Cite any recent cables that are relevant to the report (REFTEL: cable # as appropriate).

c. Summary

This section of the cable can be more than one paragraph and should summarize the findings of the disaster assessment and any actions requested.

When requesting action for OFDA/W or other offices, clearly state the action in a summary paragraph identified with the designation “action requested.” When the recommendation requires additional discussion in other paragraphs of the cable, identify these paragraphs by number in the summary section (e.g., see para 10).

Describe the disaster. How many people are affected? Where are they? For example, “A famine of significant proportions is developing in x as a result of civil unrest and drought. An

estimated y people are affected and will require food for z months.” Or for a fast onset disaster, “A typhoon of immense proportions hit the island of x, on y date. An estimated z people have been left homeless, agriculture destroyed, buildings damaged...” Cite the sources for your statistics.

Summarize what is currently being done to handle the disaster on the local, national, and international level. Mention the presence of relief agencies, both local and international; military participation; etc.

What is the Mission/Embassy doing (briefly)? Has a disaster been declared? What are the team’s summary recommendations?

d. General Situation

This introductory section should give the reader a more detailed overview of the disaster than the summary. Describe the OFDA Assessment Team. Who was on it? What was their expertise? Where did they go? How did they get there? How long did they stay? Who did they talk/meet with? Has the Embassy declared a disaster? When? Has the \$50,000 Disaster Declaration Authority been received? Expended? For whom/what?

Describe in more detail the disaster situation and provide sources for all applicable information.

- What is the extent/enormity of the problem? When did the problem begin? What is the experience of the country in previous similar situations?
- Where is the disaster occurring? How many people are affected? How many have died/are injured/homeless/ill/displaced? If displaced, are they in camps? If yes, how many people are in them? What is the population profile (children/men/women/ages)? Are more people on the move? Are they moving within the country or is a potential refugee situation evolving?
- How are the affected country government, UN/PVOs/NGOs/IOs, and donors responding? Who are they using for staff (local, international)? Is there one organization taking the lead?
- How are responders getting to the area (by road/air/boat)? Are they staying overnight or traveling there each day?

- Are there particular political/social/economic/security factors that influence the event?

e. Food and Food Distribution

If the disaster is a famine or food shortage, describe the magnitude of the food needs, numbers of people, tonnage required, and tonnage pledged to date. (E.g., “The UN estimates that x metric tons of food are required in the next 6 months to avoid massive starvation. This comes to y metric tons per week.”)

Describe the logistics of getting the food to the people: roads, water, air, relative costs, truck and worker availability, and any problems encountered (customs, contracts, etc.), including problems at ports and airports. In a conflict situation, note in particular any security problems associated with food movement.

What is being done? Who is distributing? How? Where? What problems have been encountered? Is the food getting to vulnerable groups, especially unaccompanied women and children? Mention should be made of availability of food in markets, prices, and the potential for a market sales program or other ways of getting food to people, such as food for work.

What kind of rehabilitation programs, if any, are under way (e.g., seeds and tools, fishing equipment)? Who is implementing the programs? Where?

Are there any security or discrimination (e.g., gender, ethnic) issues related to food distributions?

What more needs to be done? Further assessments? More pledges? Different foods? More funds?

f. Health and Nutrition

Describe nutritional conditions. What is the rate of malnutrition? Has it changed (improved/declined; in what areas/what groups)? Be as specific as possible. Cite sources. (E.g., “MSF/F surveys conducted in (month) have determined that rates of malnutrition of the under-5 population in x are y. Similar surveys in other areas report the same/different information.”)

Describe mortality, especially in women and children. What are the death rates (crude mortality rate, under-5 mortality rate), if known? Are the rates under or out of control?

Describe the major diseases endemic to the area. Are they increasing due to the crisis? Are other adverse health conditions (e.g., trauma, injuries) being observed due to the disaster? Have there been any disease outbreaks?

What is the condition of the local public health system in terms of ability to provide health care (curative, preventive, emergency referrals), disease surveillance and response, and qualified healthcare personnel?

Describe current health relief efforts. What humanitarian actors are on the ground and in which locations? What interventions (therapeutic feeding/immunization campaigns/primary health care/reproductive health) are being implemented?

Are there any security or discrimination issues related to these programs?

g. *Water and Sanitation*

Are water problems associated with the disaster? Describe where the population obtains water (wells/boreholes/temporary facilities or trucking/piped city system). Is the water turbid? Is any information available related to the quality of the water? Note the general appearance and smell of the water.

What is being done about the water problems? Is the water being disinfected or otherwise treated? Are facilities available for water storage? How is water being distributed? How much water is available to people per day (liters/person/day)? Where are people getting their drinking water? Who is providing it? Is there safe and easy access to water for women? How far do people have to travel to obtain potable water? Do families have appropriate containers for collecting and storing water in the household?

Are sanitation problems associated with the disaster? What provisions exist for the disposal of human feces? Is there a sewer system, and if so, has it been damaged as a result of the disaster? Are there family-owned or communal latrines? Are there temporary sanitation facilities? Are there separate

washing/sanitation facilities for women? Is there overcrowding? What is the ratio of persons to latrines? Are there solid waste disposal facilities? Are there provisions for disposal of medical waste? Is vector control a serious concern? Is a vector control program contemplated or already under way?

Is hygiene education being emphasized covering issues related to water supply and sanitation? Are qualified people available to advise, assist, and operate and maintain facilities? Is technical assistance needed?

h. Shelter

Describe damage to private and public buildings in the affected area and what caused it. What type of housing has been damaged/destroyed? How many buildings (private and public) have been damaged or destroyed? Is there likelihood that the cause of damage will be repeated in the foreseeable future? Has a value been placed on the damage? To what extent can the cause of damage be mitigated at reasonable cost?

Can materials from damaged structures be used to rebuild shelters? Are there building materials nearby? What types and quantities of building materials can the affected government provide for temporary or permanent shelter? What types and quantities of building materials are needed from external sources?

Describe the immediate needs for shelter, if any. What are the opportunities and constraints (land ownership and usage, drainage, sanitation) in meeting urgent shelter needs? Estimate the population in need of shelter. Are people at home? With relatives? In makeshift huts, community facilities, or at campsites? Is the need temporary (a few weeks), or does a displaced population require shelter for an indeterminate time?

Is there a need for clothing, water jugs, or cooking supplies (in a conflict situation, DPs will frequently arrive without clothing or household goods)?

Describe what is being done. Are there any local solutions? Who is in charge? What is the role and capacity of local government, UN, and relief agencies?

i. Capability and Capacity

As best as possible, evaluate the overall response to the disaster; the capability of the NGOs; both national and international collaborative efforts between them and problems identified; and the capacity of the host government and its policies, biases, and interests in assisting.

j. Coordination

How is the relief effort being coordinated? Who is taking the lead? Are there donors' meetings or meetings with government officials? With NGOs? Where are they held and how frequently? Did the team attend any of them? What role has the Mission/Embassy been playing? What more needs to be done?

k. Recommendations

Outline immediate actions required (be sure to identify the action items, referenced by paragraph number, in the first paragraph of the cable). If commodities are requested, specify the item, quantity needed, and other specifications as appropriate; when the commodities are needed; and how they will be received, transported, stored, and distributed. If by air, information should be provided about runway capability (dirt/paved, damaged/ intact, length), air traffic control services, and possible security problems as appropriate. If additional expertise is needed, specify what type and when. Note any issues such as customs clearances, storage, special handling, and any holidays that may interrupt delivery. Recommendations can also include making additional funds available for project proposals, additional assessments, or mobilizing a Disaster Assistance Response Team (DART).

J. Assessment Checklists

1. Introduction

The following assessment checklists are intended to assist the Assessment Team in planning, formatting, and conducting a complete initial assessment. The answers to the checklist questions will provide the information needed to complete the disaster cable formats outlined in the section, OFDA Assessment Cable Reporting Formats.

These assessment checklists are divided into major sectoral areas. They are meant to be as inclusive as possible of the types of questions that need to be answered in initial assessments of various disasters. To be answered completely, some of the questions require extensive survey work, which the team may or may not have the capacity to perform. The information may already exist, however, and the task of the team may be only to gather assessment information assembled by others and evaluate the information for accuracy, timeliness, and completeness. An Assessment Team may also find it necessary to develop new or expanded questions to gather the required information for specific disasters.

2. Victims/Displaced Population Profile

a. General Characteristics

- Determine the approximate numbers and ages of men, women, adolescents, and children (ages 0–5, 6–14, 15 and older).
- Identify ethnic/geographic origin (urban or rural).
 - Sedentary or nomadic background?
 - What is the average family/household size?
 - How many households are headed by females?
 - What are their customary skills?
 - What is (are) the language(s) used?
 - What is the customary basic diet?
 - What is the customary shelter?
 - What are the customary sanitation practices?
 - What is the general distribution of socioeconomic statuses (poor, middle class, wealthy) in the population?

b. Capacities

- What percentage of male and female population is literate?
- What emergency-related skills (e.g., health workers, individuals with logistics/organizational relief skills) are represented in the population that could be drawn on by relief organizations?

c. *Displaced Populations*

- Determine the approximate number of displaced people.
- Determine their locations. Are they moving? To where? How many?
- Determine how many are arriving per week. How many more could come?
- Determine how they are arriving. Are they scattered individuals or families or clans, tribal, ethnic, or village groups? By what means are they traveling? How did those already there arrive? What is the average family size?

d. *Physical Assets*

- Determine what the displaced population has as personal property and what was lost as a result of the disaster.
- Estimate the number and types of blankets needed (according to climatic conditions).
- Identify what blankets are available in the country from personal, commercial, UN/PVO/NGO/IO, or government stocks. Determine the need for blankets from external sources.
- Describe the clothing traditionally worn, by season and area.
- If clothing is needed, estimate the amount by age group and sex.
- Describe normal heating/cooking practices.
- Determine whether heating equipment and/or fuel is required.
- Estimate the types and quantities of heating equipment and fuel needed over a specific time period.
- Determine appropriate fuel storage and distribution mechanisms.
- Identify what fuel is available locally.
- Identify what fuel is needed from external sources.
- Determine if other personal effects, such as cooking utensils, soap, and small storage containers, are needed.

- If DPs are arriving at a temporary settlement or camp, determine whether:
 - The DPs brought any financial assets. Would those assets be convertible to local currency?
 - Livestock were brought along.
 - Shelter materials were brought along.
 - Other possessions, such as cars, bicycles, or boats, were brought along.

3. Food

a. Baseline Data

- Describe the normal consumption pattern (food basket) of the affected population, any taboos, and acceptable substitutes.
- Describe the normal food marketing system (including government involvement, imports, subsistence, and role of women).
- Indicate what food aid programs exist, if any, and describe them.
- Outline the indigenous food processing capacity.

b. Effect of the Event on Food

- Ascertain the disaster's effect on actual foodstocks and standing crops (damaged/destroyed).
- Determine if access to food (e.g., roads, milling facilities) has been disrupted and, if so, how long will it likely remain disrupted.
- Check market indicators of food shortages, such as:
 - Absence or shortage of staple grains and other foods on the market.
 - Price differential.
 - Change in supplies on the market (e.g., an increase in meat supplies may indicate that people are selling animals to get money).
 - Change in wholesale grain availability.
 - Unusual public assembly at a warehouse or dockside when grain is being unloaded.

- Changes in warehouse stocks.
- Black market price changes or increase in black market activities.
- Commercial import changes or proposed changes.
- Sale of land, tools, draft animals, etc.
- Check nutritional indicators of food shortages by gender, such as:
 - Signs of marasmus, kwashiorkor, or other signs of malnutrition.
 - Increased illness among children.
 - Change in diet (i.e., quantity, quality, type).
- Check social indicators of food shortages, such as:
 - Increased begging/fighting/prostitution.
 - Migration from rural to urban areas.

c. Food Availability

- Determine how much food can be expected from future and/or specially planted, quick-maturing crops. Where in the production cycle was the affected area when the disaster struck? Is there any possibility for immediate local purchase?
- Estimate the local government stocks on hand and those scheduled to arrive. Is borrowing of stocks on hand a possibility?
- Estimate the local commercial stocks on hand and scheduled to arrive.
- Estimate the local PVO/NGO/IO stocks on hand and scheduled to arrive. Is borrowing a possibility? Have standard procedures governing the transfer and use of commodities (Public Law 480, Title II) been considered?
- Estimate local personal stocks on hand and those scheduled to arrive.
- Determine regional availabilities.
- Canvass other donors to find out what they expect to contribute.
- Estimate how much food aid would be required during specific time periods.

d. Distribution Systems

- Describe existing food aid distribution systems (e.g., government rationing, PVOs/NGOs/IOs).
- Describe the effectiveness of the distribution system.
- Describe the role of women in the distribution system.
- Describe government marketing mechanisms.
- Judge the capacity of the above to expand/begin emergency aid. What is their record of accountability?
- Describe potential alternatives.
- Explain the country's (agency's) previous experience with mass feeding.
- Determine the availability of facilities and materials, including fuel.
- Determine whether repackaging facilities exist.
- Describe monitoring techniques at the various points of commodity transfer.
- Describe targeting mechanisms required for vulnerable groups.

e. Social and Market Impact of Food Aid

- Analyze the likely price impact on normal food suppliers. Describe the suppliers.
- Decide whether food aid would free cash and labor for other aspects of relief, or divert labor and create a dependent attitude.
- Has a Bellmon Analysis been previously required and is that analysis still relevant? This analysis is required to determine that:
 - Adequate storage facilities are available in the recipient country at the time when commodities are exported in order to prevent spoilage.
 - Importing commodities will not be a disincentive to, or interfere with, domestic production or marketing.

f. Other

- Research any legal impediments to importation of certain foods. Are there any current Genetically Modified Organism limitations and has customs been contacted?

4. Nutrition

Note: Refer to chapter III, Food and Nutrition section, for the methods used in assessing nutritional status mentioned in the section below.

a. *Nutritional Status*

- Determine rate of moderate acute malnutrition.
- Determine rate of severe acute malnutrition.
- Determine how surveys were conducted.
 - Methodology used, such as 30 by 30 cluster surveys, mid-upper arm circumference, weight for height/age, and height for age.
 - Sample size.
 - How sample was selected.
- Determine if data are available from mother and child health clinics.
- Determine if data are available from existing supplementary feeding programs (SFPs), center-based therapeutic feeding programs (TFCs), or community-based therapeutic care (CTC) programs:
 - When programs began.
 - Number of children cared for.
 - For TFCs and CTCs:
 - Mortality, cure, default rate.
 - Number of children with marasmus or kwashiorkor.
 - For SFPs:
 - Targeted or general distribution.
 - Protection rate (e.g., families of children in SFPs receiving general food rations).
 - Dry or wet ration distribution.
 - Frequency of distribution.
- If a food distribution program exists, identify:
 - Targeted or general.
 - Commodities.
 - Ration and kilocalories per person per day.

- Method of distribution (daily/weekly/monthly).
- How long has the population been receiving this ration?
- Ascertain the prior nutritional status of the affected population.

b. *Public Health-Related Risk of Malnutrition*

- Identify disease outbreaks that may affect nutrition status (e.g., measles, acute diarrhea). Is there a risk that outbreaks will occur in the future?
- Estimate the measles vaccination coverage of the population.
- Are there apparent micronutrient deficiencies?
- Estimate the vitamin A supplement coverage. Is vitamin A provided in measles vaccinations?
- Ascertain the crude mortality rate/under-5 mortality rate. What method was used to determine the rate?
- Identify factors that affect the energy requirements of the affected population or make them more vulnerable to malnutrition:
 - Presence of persons with HIV/AIDS or tuberculosis (TB).
 - Current or predicted decline in ambient air temperature (which can also increase the prevalence of acute respiratory infections).
 - Have people been in water or wet clothes for long periods of time?

c. *Care-Related Risk of Malnutrition*

- Ascertain whether changes in work patterns (e.g., due to migration, displacement, or armed conflict) have altered household composition, roles, and responsibilities. Are there large numbers of separated children?
- Determine whether the normal care environment has been disrupted (e.g., through displacement) or has altered access to water, food for children, secondary caregivers.

- Describe normal infant feeding practices:
 - Length of time mothers exclusively breastfeed their children.
 - Whether mothers are bottle-feeding or using manufactured complementary foods.
 - Is there an infrastructure that can support safe bottle feeding?
- Determine whether evidence exists of donations of baby foods and milks, bottles and teats, or requests for donations.
- In pastoral communities, have the herds been away from young children for long? Has access to milk changed from normal?
- Ascertain whether HIV/AIDS has affected caring practices at the household level.

d. Food Access-Related Risk of Malnutrition

- See the Food section of this chapter.

e. Nutrition Interventions

- Describe nutrition intervention or community-based support that existed before the disaster, and identify the groups involved (e.g., NGOs, religious groups, government or UN agencies).
- Describe nutrition policies (past, ongoing, and lapsed), planned long-term nutrition responses, and programs being implemented or planned in response to the current situation.
- Identify formal and informal local structures through which potential interventions could be channeled. Describe the capacity of the Ministry of Health, religious organizations, HIV/AIDS community support groups, infant feeding support groups, or NGOs with a long- or short-term presence in the area.
- Determine the availability of food and describe the food pipeline.
- Is the population likely to move (for pasture/assistance/work) in the near future?

5. Health

Note: Refer to chapter III, the Health section, for the methods used in calculating the prevalence and incidence rates of diseases and death.

a. Health and Demographic Information

- Determine total population affected (include host population as well as displaced), including age (under 5 years), male and female ratio, average family size, and numbers of arrivals and departures per week in displaced populations (internally or refugees).
- Identify vulnerable populations (numbers of female- or child-headed households, unaccompanied children, disabled, elderly, single women, pregnant and lactating women, etc.).
- Establish crude mortality rate. The rate of death in the entire population for all diseases.
- Establish under-5 mortality rate. The rate of death among children 59 months of age and younger.
- Obtain measles vaccination coverage for children between the ages of 6 and 59 months. (If coverage is less than 90 percent, plans should be made for a mass measles vaccination campaign that includes the administration of vitamin A to children ages 6 to 59 months. To protect the population from a measles epidemic, the coverage should be greater than 95 percent.)
- Determine diarrhea incidence (bloody/nonbloody) in adults and children less than 5 years of age.
- Establish incidence rates for other diseases of significant public health importance (cholera, yellow fever, dysentery, etc.). Ideally, the information should be disaggregated for adults and children under 5 years of age, although in emergencies it may be difficult to obtain. Identify and cite methods of diagnosis (clinical judgment, laboratory test, or other method).
- Determine or estimate the incidence of major traumatic injuries requiring surgery or hospitalization (e.g., fractures, head injuries, internal injuries).
- Identify incidence and trends of violence against women and children.

b. HIV/AIDS

- Assess baseline data for HIV/AIDS and risk factors for increasing transmission. Due to the HIV/AIDS pandemic and increasing evidence suggesting that transmission is increased in emergencies, efforts to prevent new transmissions must be started in the acute phase of an emergency.
- Conduct a rapid risk and vulnerability assessment.
 - Those at risk for HIV transmission are often context-specific but are essentially women, youth, drug addicts, and certain ethnic and religious groups that face discrimination.
 - Assess the presence of groups considered “core transmitters,” such as commercial sex workers and armed military and paramilitary personnel.
 - Evaluate interactions among displaced and local populations and communities for the risk of HIV transmission.
 - Ascertain the existing level of risk and specific factors that make the risk groups listed above more vulnerable to HIV/AIDS (e.g., trading sex for food).
 - Existing baseline data may include:
 - Voluntary blood donor testing.
 - New TB cases.
 - Trends of HIV/AIDS case surveillance reporting.
 - Incidence and trends of sexually transmitted infections disaggregated by syndrome (male urethral discharge, genital ulcer disease, syphilis at antenatal clinics).
 - Percent and trends of hospital bed occupancy of persons between 15 and 49 years of age.
 - HIV/AIDS information for the displaced population areas of origin.

c. Health System Capabilities

- Determine the number, location, and condition of all health facilities and number of usable beds. Consider using a map for graphic representation during the assessment.

- Determine the location and condition of all laboratory assets in country, including adequacy of equipment (microscopes) and supplies (reagents, gloves, slides, sharps containers, etc.). Determine laboratory capabilities for confirming major communicable diseases (malaria, cholera, shigellosis, meningitis, measles, yellow fever, and TB) and the testing of blood for transfusions for HIV/AIDS, Hepatitis B, and if possible, Hepatitis C and syphilis. Determine the effectiveness of lab referral systems.
- Identify available health personnel (doctors, nurses, community health workers, traditional birth attendants, midwives, lab technicians, etc.). Assess abilities and training needs.
- Determine the amount and type of medical supplies and drugs available locally or in-country.
- Ascertain the availability of specialized medical care at appropriate hospitals for emergencies, such as severe trauma, life-threatening diseases, and comprehensive emergency obstetric care, and the availability of transportation to these hospitals.
- Determine the availability of referral mechanisms for transferring patients to specialized care.
- Determine the presence of systems to prevent and manage cases of gender violence.

d. Local Health Programs

Describe the following health programs (if present):

- Diarrhea disease prevention and control (includes capacity of health facilities to treat dehydration from diarrhea, using oral rehydration therapy as well as capability to establish cholera treatment centers), adequacy and quality of water supply, and health education.
- Reproductive health programs including prenatal, antenatal, deliveries, emergency obstetrical care (placental abruption, post partum hemorrhage, ectopic pregnancy, obstructed labor, etc.), HIV/AIDS prevention (blood screening, use of universal infection control precautions, and condom availability), management of sexual violence, etc.

- HIV/AIDS prevention and control (access to free condoms, relevant information, and education, linked with reproductive health and primary care facilities and programs).
- TB prevention and control.
- Malnutrition assessments (see the Nutrition section of this chapter).
- Expanded Program for Immunizations.
 - Determine routine immunization coverage rate (percent of children under age 5).
 - Obtain dates of previous and/or proposed mass vaccination campaigns for measles, and possibly polio, if still present in the country. Assess whether vitamin A was given in the measles campaign. Determine if the host population and the displaced were included and the coverage rate.
 - Assess capability of relief workers and/or local health personnel to begin or sustain an immunization program, including mass campaigns and routine immunization.
 - Determine adequacy of coordination, logistics, infrastructure, cold chain (refrigerators/freezers/ freezer packs), availability of vaccines and equipment (sharps containers, adequate supplies of syringes to prevent reuse, etc.).
- Universal Infection Control Precaution Systems in health facilities and immunization campaigns to prevent transmission of HIV, Hepatitis B, and other blood-borne infections in patients and healthcare workers.

e. Health Information/Surveillance Systems

- Determine whether a health information system is in place to monitor the health of the affected population and provide disease surveillance:
 - Is a single authority responsible (e.g., the Ministry of Health) for its operation and data analysis?
 - How often is routine analysis done, and how are the results disseminated?
 - What proportion of the health facilities routinely send in health information reports and how often?
 - What diseases or health conditions are included in the system?

- Are standardized case definitions used?
- Is the system able to detect early outbreaks and provide a quick and effective response?

f. Cultural and Social Health Factors

- Describe nontraditional sources of health care (traditional healers, etc.).
- Ascertain beliefs and traditions that could affect health care and delivery, such as food taboos during infancy and pregnancy, female genital mutilation, burial practices (special precautions needed for cholera and hemorrhagic fever deaths), blood-taking, injection, and patient isolation beliefs.
- Describe the social structure and traditional leadership systems (e.g., determine if the displaced are grouped in their traditional villages and what type of social or political organization exists).
- Discuss the presence of different ethnic groups/religions and their relationships.

g. Environmental Health Factors

- Determine the status and trend of climatic conditions of health interest, such as temperature, precipitation, flooding, etc. Obtain and cite relevant information from forecasts and local knowledge of weather conditions.
- Identify significant topologic features that may influence access to health care (e.g., areas that flood during the rainy season causing landslides or preventing access to services, vector breeding habitat).
- Identify water sources, and monitor quality, equitable access, and quantity.
- Determine the local availability of materials for shelter and fuel.
- Determine whether existing shelter, water, and latrine locations and arrangements pose a safety or security risk to women and children.
- See the Shelter, Water, and Sanitation sections of this chapter for other assessment information.

6. Water

a. *Displaced Population Situation*

- Determine the number of liters of water available per person per day. Persons with HIV/AIDS and cholera may require extra water for drinking and hygiene.
- Determine the source and quality of the water.
- Determine how long the daily amount has been available.
- Determine the evidence of water-related diseases.
- Determine the length of time users wait for water.
- Determine whether safe and easy access to water is available for vulnerable groups, such as unaccompanied women and children or families affected by HIV/AIDS.
- Determine the types of wells, transportation, and/or storage systems used.
- Determine if problems exist with well repair/rehabilitation.
- Determine if equipment/expertise exists on site, is on order, or is available if needed.
- Determine the availability of additional sources of safe water if required.
- Determine if problems exist with operation and maintenance of the emergency water system.
- Determine the need for an engineering specialist to assist with evaluating requirements.

b. *Water System Disruption*

- Describe the types of systems and sources that existed before the disaster in the affected areas.
- Specify how many people have been deprived of a functional water supply.
- Determine who is in charge of the local water system(s) (e.g., community group, committee, national authority).
- Determine whether the system is still functional or the requirements for repair.
- Determine the need for an engineering specialist to assist with evaluating requirements.

7. Sanitation

a. Displaced Population Situation

- Identify the sanitation problems caused by the disaster.
- Determine the placement, number, and cleanliness of latrines.
- Determine if cultural taboos are affecting the use of latrines.
- Determine if there is an overall sanitation plan (including latrines, bathing areas, laundry sites, refuse pits, and drainage).
- Determine if safe access is available to latrines for women and girls.
- Determine the evidence of fecal-oral transmitted diseases.
- Determine the proximity of latrines and refuse areas to water sources, storage areas, distribution points, and food preparation areas.
- Determine if a plan exists for hygiene education.
- Determine if a plan exists for the collection and disposal of garbage and solid wastes.
- Determine if a plan exists for insect and rodent control.
- Determine if a plan exists for the cremation or burial of the dead, and if precautions are needed for those who have died of cholera or hemorrhagic fever.
- Determine the need for a specialist to assist with evaluating requirements.

b. Nondisplaced Population Situation

- Determine if sewage is collecting, or ponding, in or near settlement areas.
- Determine if the sewerage system and the surface drainage system are still functioning.
- Determine the adequacy of sewage disposal facilities in public buildings and other areas being used to temporarily shelter homeless people.
- Determine if garbage and solid wastes are being collected.
- Determine the need for a specialist to assist with evaluating requirements.

8. Shelter and Settlements

a. *Establishing Context*

(1) The Affected Population

- Determine the area affected (e.g., portion of city, several villages, large area of a country).
- Are important terms (e.g., houses, dwelling units, households, families, homeless) defined clearly, **and** used consistently in any reporting documents generated?
- How many people lived in the affected area before the disaster or conflict?
- How many people comprised a typical household? On average, how many people lived per occupied dwelling unit before the disaster or conflict?
- What percentage of households owned their homes before the disaster or conflict?
- Did the affected community include groups of individuals who did not form typical households, such as unaccompanied children or particular minority groups with household sizes that were not considered typical?
- How did people earn a living before the disaster or conflict? What incomes did they have? What assets did households have? What was lost, and what remains?
- What household and livelihood support activities typically took place in and around the dwelling units of the affected population, and how did the resulting space provision and design reflect these activities?

(2) Housing Delivery System

- Who builds the housing?
- How is the housing built?
- How long does it take to build a typical dwelling unit?
- What materials are used?
- Where do the materials come from?
- What is the availability and cost of materials?

b. Identifying Impacts, Resources, and Opportunities

(1) Impacts

- What caused the housing damage? Is there likelihood that the cause of damage will be repeated in the foreseeable future? To what extent can the cause of damage be mitigated at reasonable cost?
- What is the degree of accessibility to the affected areas for assessment and possible delivery of relief supplies?
- How many households (and people) in the affected area sustained damage to their homes? What are the percentages of housing supply and population directly affected by disaster or conflict in affected areas?
- How many households are without any shelter or have inadequate shelter, and where are they? What does this number represent in terms of a percentage of total households in the affected area?
- Is the need for shelter temporary (a few weeks), or does a displaced population require shelter for an indeterminate time?
- Has a damage profile, which catalogs the varying degrees of housing damage from undamaged to destroyed, been developed? Estimate the number of private dwellings (single-family, attached, low-rise, and high-rise multiple family) and public buildings (schools, churches, hospitals) damaged or destroyed by city, village, or region. Determine the number of damaged dwellings that are habitable without immediate repair, habitable only after repair, and not habitable and must be destroyed.
- To what extent were nonhousing structures (e.g., shops, offices, and public buildings) also damaged? These structures might serve as resources for subsequent shelter provision, giving careful consideration to access to sanitation and water, and are also critical indicators of community well-being and security; therefore, the impact of disasters and conflicts on these structures should be documented.

- If relocation is necessary due to the nature of the disaster, what impacts might this cause on the local population? With resident populations in potential relocation areas?

(2) Resources

- What initial shelter solutions or materials have been provided to date by the affected households or other actors?
- Do affected families have friends and relatives who can provide assistance?
- What existing materials can be salvaged from the damaged site (if applicable) for use in the reconstruction of shelters?
- What are the typical building practices of the displaced and host populations, and what are the different materials that are used to provide the structural frame, roof, and external wall enclosures?
- What alternative design or materials solutions are potentially available and familiar or acceptable to the affected population? Would these materials meet cultural and disaster-resistance requirements?
- What are the types and quantities of building materials that the affected government can provide for the victims for temporary or permanent shelter? What are the types and quantities of materials needed from external sources for temporary or permanent shelter?
- What is the suitability (i.e., infrastructure support) of available sites for temporary and permanent shelters, including, where necessary, mass sheltering? Would environmental conditions impose constraints on temporary shelters or camps, such as all-season accessibility, proximity to sources of essential supplies (shelter materials, cooking fuel, water, etc.), soil, topography, drainage, and vegetation?

(3) Opportunities

- What local, national, and international organizations are present in affected areas? What are the capacities of these organizations, and what are they planning?
- What are the current material, financial, and human resources and constraints of the affected households

and the community to meet some or all of their urgent shelter needs?

- What are the opportunities and constraints of the host population in accommodating displaced households in their own dwellings or on adjacent land?
- What are the opportunities and constraints of using existing, available, and unaffected buildings or structures to temporarily accommodate displaced households?
- What are the requirements and constraints of local authority regulations in formulating shelter solutions?
- What is the current provision of social facilities (health clinics, schools, places of worship, etc.), and what are the constraints and opportunities related to accessing these facilities?
- What are the organizational and planning issues of accommodating the displaced households in host communities or in temporary settlements?
- What are the environmental concerns in providing shelter assistance (e.g., access and sourcing shelter materials) and in supporting the displaced households (e.g., fuel, sanitation, waste disposal, grazing for animals if appropriate)?
- What opportunities are present for building local shelter/settlement provision and management capacities?
- How can women, youths, and older people be trained or assisted to participate in the building of their own shelters, and what are the constraints?
- What livelihood support opportunities can be provided through the sourcing of materials and the construction of shelter and settlement solutions?
- How can the identified shelter solutions incorporate disaster prevention and mitigation concerns?
- What is the topographical and environmental suitability of accessible vacant land to accommodate temporary settlements? What are the potential hazards and security vulnerabilities of available sites for temporary and permanent shelters?

- What are the opportunities and constraints of current patterns of land ownership, land usage, drainage, and sanitation, and the availability of vacant land, in helping to meet urgent shelter needs?

9. Agriculture and Livestock

Refer to chapter III, Agriculture and Livestock section, for background information.

a. *Baseline Data*

- Describe crops grown in the affected area:
 - Crop name.
 - Average area planted (per data available).
 - Average production (per data available).
 - Planting season(s) (dates) and time to maturity.
 - Are crops climate specific? If so, identify the climatic requirements.
 - Are hybrid seeds being used in the area? If so, identify them.
 - Are they cash or subsistence crops?
- Describe domestic animals present in each affected area:
 - Approximate number of animals in the area.
 - Value of individual animals.
 - Use of animals for food.
 - Use of animals for work.
 - Use of animals for cash production.
 - Are bred stocks used in the area?
- Describe the agricultural system:
 - Main agriculturist in family units (male/female).
 - Land-use systems.
 - Agricultural labor system/land tenure.
 - Crop preferences.
 - Inputs.
 - Seeds (reserved or purchases). Is treated seed used?

- Fertilizer.
- Machinery/tools.
- Pesticides.
- Storage (farm, government, private).
- Agribusiness facilities; processing of local or imported commodities.
- Describe the local fishing industry.

b. *Effect of the Event on Agriculture*

- Ascertain the extent of damage to crop/fisheries by area, noting at what point in the production cycle the event occurred. State the source of the information.
- Estimate the loss in production (tonnage/head) by crop/fisheries and by zone within the affected area. Is the output expected sufficient to cover consumption needs of the community (or household)? If not, how do families plan to meet those needs?
- Analyze whether losses will increase over time and state why or why not.
- Describe the damage to agricultural machinery.
- Describe the damage to irrigation systems.
- Describe the damage to seed, fertilizer, and pesticide stocks.
- Describe the damage to fishing ponds, farms, and gear.
- For a drought, compare the current rainfall to the normal or recent past precipitation.
- Identify any unusual or untimely grazing changes.
- Describe any threats from insects or disease that might follow the disaster.
- Describe the current terms of trade for rural farmers and livestock owners based on market information from rural areas (not major cities).
- Compare prices, availability, and quality of staple grains on rural markets with those of the last good year, as well as over the past several months. Indicate where the grain comes from (e.g., locally produced, imported from other regions or countries). Note availability of other commodities (e.g., vegetables, spices, oil).

- Compare prices and condition of livestock on markets with those of the last good year, as well as over the past several months. How far are livestock owners traveling to sell their animals? Are buyers actively purchasing animals? Are signs of distress sales of animals evident? Talk with the sellers to determine why they are selling their animals, and look for camels, cows, and young calves on the market.
- Analyze farmers' access to fields for planting, weeding, and harvesting (particularly in refugee situations). Is access assured during the entire agricultural cycle or will conflict or migration prevent harvest?
- Describe how fields are normally prepared for planting, and estimate community capacity to prepare land this year (labor, animal traction, etc.).
- Identify start of next major planting season, what crops are commonly planted, and when seeds of these crops must be in farmers' hands to ensure that fields will be planted on time. Identify seed varieties that are suitable to the agro-ecological area and are known to farmers.
- Analyze seed availability and access by rural farmers. If sufficient quantities or appropriate varieties are not available, describe the specific causes of shortage.
- Estimate how much land was planted in the affected area during the most recent growing season, and compare this amount to average. Describe where farmers obtained seed for the previous season (if situation is ongoing and not a sudden disaster) and likelihood that farmers will be able to access the same source this season.
- Describe the availability of farming tools for individual households, and explain what hand tools could enhance productivity. Note local or regional sources of tools and whether tools were distributed for the previous season's planting.
- Examine other constraints (e.g., seed storage, soil fertility, water availability) that merit attention, and discuss how they can be addressed.

c. *Effect of the Event on Livestock*

- Identify the primary livestock holdings in the area (e.g., camels, sheep, cattle, goats). Describe the local uses of livestock, the economic and cultural implications of these

roles, and the extent to which livestock contribute to household food intake at different times of the year.

- Discuss the levels of livestock losses that are acceptable while still maintaining viable herds or flocks. Is increasing animal mortality evident? List the primary factors leading to animal deaths.
- Describe the level of market access held by livestock owners and the ability of these owners to offtake animals from herds in difficult times.
- Determine feed availability for animals, and the condition of pasture and water resources at home and along migration routes. Have migration routes changed significantly this year?
- Discuss relevant laws related to livestock slaughter or transport.
- Ascertain the estimated duration and severity of the emergency, as well as the potential livestock losses. What is the estimated length of time needed to rebuild the pastoral economy?
- Describe the regional and local animal healthcare systems, and determine what needs are met by these systems.

d. *Agricultural Production Capabilities*

- Ascertain availability of inputs by type (e.g., seed, fertilizer, pesticides, tools, machinery, veterinary medicines, fishing boats, nets, breeding stock).
- Estimate the local government stocks on hand and when they are scheduled to arrive.
- Estimate the local commercial stocks on hand and when they are scheduled to arrive.
- Estimate the local personal stocks on hand and when they are scheduled to arrive.
- Ask the victims how they plan to cope with losses.
- Determine regional availabilities and elasticity of supplies.
- Ascertain what other donors plan to supply.
- Outline what further inputs would be required to restore minimum productivity.
- Find out if repackaging facilities for seed, fertilizer, and pesticides exist.

- Identify distribution systems/technical infrastructure.
- Outline host government (Ministry of Agriculture) operations in the affected area. Does it provide:
 - Extension service?
 - Crop storage/silos?
 - Veterinary services?
 - Irrigation services?
 - Research facilities?
 - Hybrid seed?
 - Fertilizer?
 - Other plants (fruit trees)?
 - Pesticides?

e. Other

- Describe any agricultural projects and inputs provided by foreign organizations or governments.
- Describe the operations of rural or agricultural credit organizations, cooperatives, or credit-sharing organizations present in the affected area.
- Judge the capacity of the above to incorporate rehabilitation disaster assistance.

10. Search and Rescue

- Determine how many collapsed structures in an urban area have been affected:
 - What types?
 - Hospitals, multistory public housing units, schools?
- Identify buildings constructed of reinforced concrete or other materials that would leave voids where trapped victims could survive:
 - Apartment buildings.
 - Industrial buildings.
 - Office buildings.
 - Hazardous installations creating secondary risks.

- Determine the predominant building types and construction material:
 - Wattle and daub.
 - Masonry buildings (adobe, brick, concrete blocks, stone masonry).
 - Reinforced concrete structures (frames with brick infill, frames with load-bearing masonry walls, bearing walls, prefabricated structures).
 - Steel structures (multistory steel structures, steel frames in an enfilade arrangement with reinforced concrete).
 - Timber structures.
 - Other.
 - Type of roof (reinforced concrete, steel, wood, grass, etc.).
- Determine the likelihood of finding survivors.
- Describe the local search and rescue capacity, and whether international Urban Search and Rescue (USAR) teams are on the ground or have been requested.
- Determine type of assistance needed:
 - Search with technical equipment and/or dogs.
 - Rescue with lifting, pulling, cutting, digging, and lighting equipment.
 - Medical to oversee and aid in victim extraction.
 - Special operations for removing hazardous materials, demolition, shoring of dangerous structures, or damage and emergency repair.

11. Logistics

a. Airports

- Identify the airport being assessed by:
 - Name.
 - Designator.
 - Location.
 - Elevation.

- Describe the current condition of facilities.
- Ascertain whether the airport is fully operational. Daylight hours only?
- Furnish information on usable runway lengths and location(s).
- Determine whether taxiways, parking areas, and cargo handling areas are intact.
- Establish whether runway and approach lights are operating.
- Specify which navigational aids are operating.
- Describe available communications facilities.
- Determine whether the terminal building is operating.
- Check the availability and cost of aviation fuel.
- Find out if facilities exist for mandatory aircrew rest.
- Explore whether the cargo handling area can be lit for night cargo operations.
- Determine what cargo handling equipment is available, including fuel and operators:
 - Forklifts (number, capacity).
 - Scissors lift (capacity).
 - Cargo dollies (number).
 - Trucks with drivers and laborers for hand unloading.
- Determine what startup equipment is available, including fuel and operators.
- Describe maintenance operations (facilities, personnel, hours).
- Outline what storage is available:
 - Covered?
 - At the airport? Off airport? How far?
 - Capacity and suitability for storage of foods or other perishables?

b. Civil Aviation

- Find out whether arrangements can be made for prompt overflight and landing clearances.
- Ascertain that the air controller service is functioning.

- Specify working hours for airport personnel.
- Explore having “no objections” fees or “royalty” fees waived or paid locally.
- Find out if arrangements can be made to work around the clock, including customs.
- Identify personnel to tally and document cargo when received and transshipped.
- Ascertain that the host government will accept deliveries by means of military as well as civil aircraft.
- Describe security arrangements.
- Determine what repairs and/or auxiliary equipment would be needed to increase airport capacity. How soon can local authorities be expected to restore service?
- Determine if any local air carriers exist and what their availability and rates are.

c. *Alternative Aircraft*

- Identify any usable airports or suitable helicopter landing sites in the disaster zone.
- Determine the local availability and cost of helicopters and/ or fixed wing aircraft.
- Estimate their capacity.
- Identify the owners/agents.
- Determine the availability and cost of fuel.

d. *Seaports*

- Identify the port being assessed by:
 - Name and location.
 - Current description of the condition of the facilities.
 - Whether the port is fully operational. Daylight hours only?
 - Security fences/facilities.
 - Percentage of port losses reported.
 - Collection for port losses possible?

- Determine whether the disaster has altered any of the following physical characteristics of the port:
 - Depth of approach channels.
 - Harbor.
 - Turning basin.
 - Alongside piers/wharves.
 - Availability of lighters.
- Determine whether the disaster has blocked or damaged port facilities:
 - Locks.
 - Canals.
 - Piers/wharfs.
 - Sheds.
 - Bridges.
 - Water/fuel storage facilities.
 - Communications facilities.
 - Customs facilities.
- Describe the berths:
 - Number.
 - Length.
 - Draft alongside (high tide and low tide).
 - Served by rail? Road? Sheds? Lighters only?
 - Availability.
- Check the availability and cost of fuel. Outline what storage is available:
 - Determine what cargo handling equipment is available, including condition, fuel, and operators.
 - Heavy lift cranes (number, capacity).
 - Container and pallet handling (with port equipment? with ship's gear only?).
- Outline what storage is available:
 - Covered?
 - Hardstand space?
 - Capacity?

- Quality?
- Security?
- Find out if pilots, tugs, and line handlers are available.
- Specify the working hours for the port.
- Specify the working hours for customs.
- Determine whether arrangements can be made with the port and host-country authorities to obtain priority berthing for vessels delivering disaster relief shipments.
- Identify an adequate number of personnel to tally and document cargo when received and transshipped.
- Check the history of turnover time. What effect has the disaster had on turnover time?
- Determine what repairs and/or auxiliary equipment would be needed to increase the port's capacity. How soon can local authorities be expected to restore service?

e. *Transfer Points*

- Identify transfer points by location.
- Determine whether surface transportation for cargo is available from airports and seaports:
 - Road?
 - Railroad?
 - Canal/river?
- Estimate the capacity of transfer points, including handling.
- Outline what storage is available.
- Describe security arrangements.
- Identify an adequate number of personnel to receive and document cargo for transshipment.

f. *Trucking*

- Describe damage to the road network as it relates to the possibility of delivering relief supplies by truck.
- Indicate any restrictions, such as weight, width, length, or height limitations at bridges, tunnels, etc.
- Determine whether bypassing damaged sections of the road network is possible and what weight restrictions would apply.

- Determine whether containers can be moved inland:
 - 20- or 40-foot container sizes?
 - To the disaster site or to a transfer point?
- Check the availability and cost of trucks owned by the government of the affected country.
- Check the availability and cost of UN/PVO/NGO/IO-owned or operated vehicles.
- Check the availability and cost of commercial vehicles.
- Determine the types, sizes, and number of commercial vehicles available.
- Judge whether the relief program could or should contract for any of the above trucks. What would be the freight rates per ton? What about collection for losses?
- Ascertain that maintenance facilities and spare parts are available.
- Outline measures to provide for security of cargo in transit.
- Check the availability and cost of fuel.

g. Railroads

- Identify and locate any railroads in the disaster-stricken area. Assess their current condition.
- Describe any damage to the electrical power system.
- Identify any interdictions—damaged bridges and tracks, fallen trees, etc.
- If moving shipments between counties, determine if tracks are compatible.
- Judge the reliability of the rail system.
- Determine whether cars can be made available for relief shipments on a priority basis.
- Determine the capacity and cost of rail shipments.
- Outline security measures to protect cargo in transit.

h. Warehousing

- Identify undamaged or damaged but usable warehouses located in reasonable proximity to the disaster site.
- Determine the capacity of these warehouses.
- Determine their availability over a specific period of time.

- Specify whether the warehouses are government-owned, UN/PVO/NGO/IO-owned, or privately owned.
- Determine whether they are staffed.
- Determine the cost per square meter.
- Assess the adequacy of the warehouses' construction:
 - Ventilation?
 - Lighting?
 - Hard floor?
 - Fireproofing?
 - Loading docks?
 - Condition of roof (check during day)?
- Describe available loading/unloading equipment:
 - Pallets.
 - Forklifts and fuel.
- Ascertain that adequate security exists:
 - Perimeter fence.
 - Lighting.
 - Guards.
- Determine whether any refrigeration is available.
- Determine whether sorting and repackaging facilities exist.
- Determine whether fumigation is necessary and if the warehouse is available for food, medicines, etc.
- If assessing a functioning warehouse, determine:
 - Accounting and recordkeeping procedures.
 - Bin/stock cards on piles. (They must match the warehouse register.)
 - Physical inventory checks at random intervals.
 - Use of waybills.
 - Stacking methods.
 - Spacing system between rows.
 - Cleanliness.
 - Commodity handling system.

- Reconstitution of damaged goods.
- Prompt disposal of damaged goods.
- First in/first out system.

12. Infrastructure

- Determine the predisaster condition of the infrastructure.
- Ascertain from the affected government the minimum needs for infrastructure recovery.

a. Communications

- Describe where the system's facilities are located.
- Determine the broadcast/reception area or zone of influence (e.g., towns serviced by the system).
- Identify the organization/firm responsible for operation and maintenance of the system. Is there a disaster response plan with identification of priority facilities, material supply, and priority screening of messages?
- Obtain technical information, such as:
 - Broadcast power.
 - Operating frequencies, call signs.
 - Relay/transmission points.
 - Hours of operation.
 - Standby power sources.
 - Mobile capability.
 - Repair/maintenance facilities, including capabilities of manufacturer's local agent.
 - Language of transmission.
- Identify key personnel (owners, management, operations, maintenance).
- Determine the degree of integration of military and civilian communications networks.
- Note the source(s) of the above information.
- Determine which communications facilities exist that are operable or easily repaired and could be used to pass on assessment information and assist in coordination of lifesaving responses.

- Identify the type of system assessed:
 - Radio.
 - Private ownership.
 - Commercial.
 - Broadcast.
 - Two-way.
 - Amateur.
 - Citizens band.
 - Public systems.
 - Police.
 - Armed forces.
 - Government agencies. (Which ministries have communications facilities?)
 - Telephone.
 - Cable and wireless.
 - Television.
 - Newspaper.
 - Other.
- Describe specific reasons why a system is not operating.
 - Unavailability of:
 - Personnel.
 - Power.
 - Fuel.
 - Access to facilities.
 - Damage to system:
 - Broadcast/transmission equipment.
 - Antennae.
 - Buildings.
 - Transmission lines.
 - Relay facilities.
 - Power source.
 - Other.

- Note source(s) of the above information.
- Outline options for restoring minimum essential services.
- Identify local/regional suppliers of communications equipment and materials available for repair. Check cost and availability.
- Determine the local/regional availability of technical services available for repair.

b. Electric Power

- Describe the power system, including:
 - Baseload facility.
 - Peaking facility.
 - Number of units.
 - Fuel source.
 - Plant controls.
 - Output capability (specify voltage and cycle).
 - Mobile plants.
 - Other standby capability.
 - Switching facilities.
 - Transmission facilities.
 - Distribution facilities (number of substations).
 - Interconnections.
- Inventory auxiliary equipment that may be available locally (e.g., from construction companies).
- Determine why power is not available (i.e., at what point the system has been damaged).
- Ascertain the condition of generating units.
- Check the integrity of the fuel system.
- Determine whether towers, lines, and/or grounding lines are down.
- Assess the condition of substations.
- Outline the impact of power loss on key facilities, such as hospitals and water pumping stations.
- Describe the options for restoring minimum essential services.

- Ascertain whether load shedding and/or switching to another grid can restore minimal services.
- Identify local/regional suppliers of equipment and materials. Check the cost and availability.
- Determine the local/regional availability of technical services available for repair.

c. *Community Water Supply and Wastewater Treatment/Disposal*

- Describe the preexisting systems:
 - Water supply: sources, distribution system, pump stations, and treatment facilities.
 - Wastewater treatment/disposal: sewer lines, pump stations, and treatment facilities.
- Estimate the number of people who depend on the various water sources.
- Determine why water, especially potable water, is not available. Determine what points in the system are non-functional or damaged.
- Check the integrity and quality of the water sources.
- Assess the condition of water and wastewater treatment facilities and the condition of the distribution system. Are pump stations operational?
- Determine whether water mains are broken. Are leaks in the sewer lines potentially contaminating the water supply?
- Outline the impact of water loss on key facilities and individual users. How quickly can the responsible ministries be expected to restore services?
- Describe options for restoring minimum essential services.
- Evaluate possible alternative water sources.
- Identify local/regional suppliers of equipment and materials. Check cost and availability.
- Determine the local/regional availability of technical services available for repair.

d. Hydraulic Structures (Dams, Levees, Irrigation Canals, Hydropower Facilities)

- Describe the function of the facilities, their proximity to the stricken area, and possible effects resulting from the disaster.
- Identify the affected country organization that maintains and operates the facilities.
- Identify the suppliers, contractors, and/or donors who constructed the structures. What were the equipment and technical sources?
- Describe any damage to structures.
- Check the stability of the structures and their appurtenances. Is there any significant water leak from structures, appurtenances, or surrounding ground?
- Identify any immediate or near-term safety risks (generating and control machinery, structural defects, power to operate gates, etc.). What are the risks to populations downstream associated with the failure of these structures and their appurtenances?
- Assess the condition of canals or downstream channels. Are there any obstructions to the outlet works that constitute a hazard to hydraulic structures?
- Identify any changes in watershed conditions (e.g., new developments, deforestation, changes in the river course, new impoundments).
- Determine whether water is being contaminated.
- Evaluate the management of the facilities.
- Determine whether storage and outflow quantities are being managed in accordance with reservoir operation rules and procedure.
- Identify preparations for follow-on storm conditions. For example, can water in a reservoir be drained during an emergency? What will be impacts on downstream population?
- Describe the potential impacts of draining a reservoir on downstream areas and relief/response efforts (e.g., location of downstream population/settlements and infrastructure, depth at river crossings, condition of irrigation canals). Is there a need to impound water until downstream works can be repaired?

- Outline the options for restoring minimum essential services and safety.
- Outline the repair plans of the responsible affected country officials.
- Check on any proposed assistance from the original donors of the facilities.
- Identify local/regional sources of equipment and technical expertise.

e. *Roads and Bridges*

- Describe the road networks in the affected area by type. What is the load capacity of the bridges?
- Identify the responsible ministries and district offices and constraints on their operations.
- Describe any damage to the network.
- Determine which segments are undamaged, which can be traveled on with delays, and which are impassable.
- Describe any damage by type:
 - Blockage by landslides, fallen trees, etc.
 - Embankments.
 - Drainage structures.
 - Bridges/tunnels.
 - Road surfaces.
- Identify alternate crossings and/or routes.
- Evaluate the importance of the road network to the relief effort and rehabilitation.
- Outline the options for restoring minimum essential service.
- Determine which elements must be restored first.
- Describe the need for traffic control (police, military, other) on damaged or one-way segments.
- Determine how long the emergency repairs can accommodate relief traffic (size, weight, volume). Will emergency maintenance and fuel points be needed in remote areas?
- Identify the affected country agencies and military and/or civilian forces that are available to make repairs. Do they have equipment, spare parts, and maintenance support?

- Check whether local or expatriate construction companies can loan equipment and/or expertise.
- Check regional sources of equipment and/or expertise that are available for repair.
- Ascertain that arrangements can be made for standby forces at damaged sections to keep roads open.

Chapter III

Information on Populations at Risk

INFORMATION ON POPULATIONS AT RISK

The information in this chapter is designed to provide team members background information for understanding terms, concepts, procedures, and measurements used in disaster relief for populations at risk. The information can also be used to help evaluate the design, quality, and accuracy of assessments conducted by other specialists, organizations, and governments and for monitoring ongoing programs.

A. Introduction

This chapter provides reference information for dealing with populations that are at risk. This information is useful for Assessment Teams gathering information on the plight and condition of at-risk populations or for a Disaster Assistance Response Team (DART) that has been sent to assist in dealing with relief activities targeted at people at risk.

At-risk populations are those groups of people who are vulnerable to the adverse effects of a disaster (natural or human-caused) and have been placed in situations where they are at an increased risk to their health or safety. They are at risk because of the disruption or loss of their normal community and social support systems that provide the critical elements of their survival: water, food, health care, shelter, and sanitation. The negative impacts on at-risk populations typically increase the longer people are displaced from their homes. In some cases, these populations have also traveled great distances from their homes to escape protracted disasters, such as famine, drought, and civil strife.

B. Immediate Response

1. Protection of Populations at Risk

An immediate need for at-risk populations is a secure location where their safety and human rights are ensured. Initiating an assistance program in an unsafe location or an atmosphere of vulnerability to violence or discrimination is difficult.

Because the Office of U.S. Foreign Disaster Assistance's (OFDA's) humanitarian assistance is often undertaken in areas that are potentially dangerous for at-risk populations, all OFDA field staff

should maintain an awareness of the security problems facing target populations and the positive or negative impacts that assistance programs can have in such contexts. OFDA seeks to apply a “protection mindset” to its assessments, strategies, monitoring, and evaluation of assistance programs. At a minimum, the goal is to ensure that assistance programs “do no harm,” e.g., do not aggravate local tensions, expose target populations to greater danger, or inadvertently further empower those who are responsible for conflict or abuse. In some situations, wisely designed and implemented assistance programs can mitigate or prevent protection problems, such as violence, abuse, theft, harassment, or exploitation. In short, OFDA seeks to provide assistance in ways that enhance protection.

The U.S. Agency for International Development (USAID) uses a broad definition of protection, believing that at-risk populations should be granted the full security and protection provided under applicable norms of national law, international human rights law, and international humanitarian law for which the United States has ratified the treaties or conventions in question or otherwise has accepted these principles as reflecting customary international law. In situations of armed conflict, principles and rules of international humanitarian law guide OFDA assistance. In addition, the United Nations’ (UN’s) Guiding Principles on Internal Displacement, although not accepted by the United States as an expression of governing international law, offer a useful tool and framework for dealing with the affected population.

a. Protection Problems

Examples of protection problems encountered by at-risk populations targeted for OFDA assistance include:

- Attacks on displaced person (DP) camps by armed groups.
- Blockage of humanitarian deliveries.
- Theft or diversion of food or nonfood items after distribution to targeted populations.
- Refusal of aid by needy populations for fear of attracting attacks.
- Detention or harassment of at-risk populations by local security personnel.
- Forcible return home of displaced populations.

- Forced conscription of young males at assistance sites.
- Sexual violence against women and girls.
- Tensions between DPs and local populations.
- Use of at-risk populations as human shields.
- Loss of identity cards or poor registration procedures at internally displaced person (IDP) sites.
- Resorting to prostitution for survival.

b. Possible Actions

Although OFDA assistance programs may be incapable of immediately eliminating protection problems faced by the affected population, OFDA staff should seek to promote protection to the extent possible by being aware of sources of vulnerability and seeking to reduce them. In particularly severe situations, OFDA may need to pursue an outcome with the fewest negative effects rather than an ideal solution that is unattainable. Key questions and considerations help provide a protection component for humanitarian assistance programs.

- Do local authorities view the at-risk population sympathetically? What divisions might exist along ethnic, religious, or political lines in areas of assistance?

Cooperation with local officials can help OFDA provide humanitarian assistance effectively, and ascertaining the possible biases and interests of these officials can help to identify potential protection problems for at-risk populations.

- Within at-risk populations, what groups are particularly vulnerable, and why?

At-risk populations are not homogenous. Some sub-groups are more vulnerable than others or less capable of getting their fair share.

- How reliable and comprehensive are available data? Are data disaggregated by gender and age?

Statistics often determine how an emergency is perceived and how the outside world responds. Wildly inaccurate data can skew the humanitarian response, miss critical needs, or result in mistaken priorities. Data disaggregated by gender and age, if available, will usually provide a

better understanding of problems that otherwise would not be readily apparent.

- Have targeted populations been consulted about their needs and concerns? Do “leaders” among the targeted population truly represent the population’s best interests?

Consultation can uncover problems of aid diversion, harassment, nighttime violence, and other protection issues that are not readily apparent. Consultation can also reveal ways to better provide assistance. Group leaders who do not have the trust of their followers may undermine the effectiveness and impartiality of assistance programs.

- Are women in the target group properly involved in program design and implementation?

When women and children are not part of the planning and implementation phases, their local expertise and opinions are not tapped and project design will likely fail to address gender-sensitive topics. So that all types of needs and capacities are represented, the women and youth chosen to help design and implement programs should, as much as possible, reflect the sociocultural variability within the population.

- Can assistance be delivered or infrastructure constructed in ways that might enhance protection?

Latrines, health clinics, and other infrastructure should be positioned with an eye to the proper balance between safety and privacy. In some situations, routine assistance activities such as food distributions can be safer or more dangerous for targeted populations depending on the time of day, distance from homes, and the amounts distributed. Proper monitoring of assistance activities can identify or prevent protection problems.

- What steps can be taken to help at-risk populations mitigate their own protection problems?

When possible, at-risk populations should be empowered to act in support of their own protection. Affected populations almost always know more than humanitarian agencies about their predicament, the nature and timing of the threats confronting them, the mindset of the people posing threats, and opportunities to resist those threats.

2. Organizational Considerations for Displaced Persons

Once the situation and needs have been assessed and the protection of individuals has been secured, the priority will be to provide vital assistance to the affected population. In situations in which populations are displaced, key organizational and planning decisions that may determine the future of relief operations must be made. These decisions involve the issues summarized below. If the following issues are not quickly and correctly addressed, they will be difficult to resolve later:

- The location of the DPs will have a major influence on how assistance is provided. If the DPs are not already concentrated in settlements, they should not be relocated to settlements unless compelling reasons exist for breaking their pattern of spontaneous and informal settlements. New arrivals may need to be diverted elsewhere. On the other hand, if they are already in settlements that are unsatisfactory, the settlements must be improved or they must be moved. Particular attention should be paid to the special needs of women and children. The difficulty in moving DPs from an unsuitable site often increases markedly with time.
- Reception or transit centers are generally recommended when an influx is likely to continue.
- The optimum population for a campsite should be determined and the camp designed accordingly. Careful control of the camp population should be exercised so that the different sections of the camp are filled in an orderly manner as people arrive.
- An accurate estimate of numbers of people in the camp is important for assistance to be effective. Family registration and a fair distribution system should be established first.

3. Material Assistance

The specific type and amount of emergency assistance required will depend on the factors to consider for each situation. These factors are as follows:

- The general condition of the affected population (people in extreme distress will need extraordinary measures).
- The immediately available resources (e.g., unfamiliar food may have to be used if nothing else can be found).
- The normal customs of the affected population.

The type and amount of emergency assistance must be consistent with the aim of ensuring the survival and basic well-being of the affected population, fairly applied, and respected by all.

The first priority in an emergency is to provide the organizational framework required to meet the needs of the emergency. The affected country, UN relief organizations, private voluntary organizations (PVOs), nongovernmental organizations (NGOs), and international organizations (IOs) must be mobilized according to a plan for immediate action. Ensuring that the involved parties have the logistical capacity needed to deliver the assistance will be of critical importance.

When the organizational framework has been established, the immediate needs of the affected population must be met. The following is a list of needs in the order of their importance.

- **Water.** Determine the water needs of the population. Protect existing water sources from pollution, and establish new sources if needed. Establish storage facilities to meet the population's needs. Transport water to the campsite if the need cannot otherwise be met.
- **Food.** Ensure that at least the minimum need for energy is met (a full ration can follow). Set up special feeding programs if clear indications of malnutrition are present. Establish storage facilities.
- **Immunization for Measles.** Ideally, a mass measles immunization program should be instituted where displaced people, crowded or unsanitary conditions, and/or widespread malnutrition are present, regardless of whether or not measles has been reported. The target age group depends on the vaccine coverage in the country of origin of the affected population. The optimal age group is 6 months through 14 years of age. If resources are scarce, immunize children aged 6 months through 59 months. Provide appropriate vitamin A supplementation. If significant malnutrition is present, implementing a measles immunization program as soon as possible is absolutely essential. After diarrhea, measles is the highest cause of death among children under 5 years of age in DP situations.
- **Health Care.** Provide the necessary organizational assistance, health personnel, basic drugs, and equipment in close consultation with national and local health authorities. Although

the immediate need and demand may be for curative care, preventative, reproductive, and particularly environmental health measures should not be neglected.

- **Emergency Shelter.** Use local supplies and services, when possible, to meet shelter needs for roofing and other materials. Request outside supplies (e.g., plastic sheeting, tents) only if absolutely necessary.
- **Sanitation.** Isolate human excreta from water sources and inhabited areas. Design appropriate sites for defecation and waste disposal.

Promote self-sufficiency in the affected population from the start; involve them in the planning for their welfare. This task may be difficult, but if the affected population is not involved, the effectiveness of the emergency assistance will be severely reduced, and an early opportunity to help them to start recovering from the psychological effects of their ordeal may be missed.

The remaining sections in this chapter provide an indepth review of the needs of communities affected by a disaster, focusing on water, food and nutrition, health, DP camps, and sanitation and environmental health issues. While the discussion in these sections often emphasizes IDPs, most of the material is also applicable to assisting with the relief needs of any population impacted by disaster or conflict.

C. Water

1. General

People can survive much longer without food than without water. Thus, the provision of water demands immediate attention from the start of an emergency. The objective is to ensure the availability of enough safe drinking water to meet at least minimal health and hygiene needs, including drinking, cooking, washing, and bathing. While the discussion in this section emphasizes DP camps to a great extent, most of the material is also applicable to assisting with the water concerns of small communities impacted by disaster or conflict.

Adequate storage capacity and backup systems for all water supplies must be ensured, because interruptions in the water supply may be disastrous. To avoid contamination, all sources of water used by displaced populations must be isolated from sanitation facilities and other sources of contamination.

Availability will generally be the determining factor in providing sufficient quantities of safe water. It may be necessary to make special arrangements for water source selection and/or development, pumping, storage, and distribution. To ensure the safety of water from the source to ultimate consumption in the home, measures will be required to protect the water from contamination at all points in the system. Disinfection or other forms of treatment may be required to ensure that the water is safe to drink.

Improvements in the existing water supply may take time, particularly if drilling or digging wells or constructing pipelines is necessary. In many DP emergencies, only contaminated surface water (standing water, streams, or rivers) is initially available. Immediate action must be taken to stop further pollution of the source and to determine if the water can be made safe. If it becomes evident that available sources of water are of inadequate quantity or unsafe, arrangements must be made to bring in water by truck. When the basic water needs cannot safely be met from existing sources in the area, and new sources cannot be readily developed, the DPs should be moved to a more suitable location.

Available water sources must be immediately protected from pollution, especially human and animal excreta. Initially, rationing of scarce water may be needed. An influx of displaced people may overburden water resources used by the local population. Rationing will ensure survival of the weak and equity in distribution to the rest of the displaced population. The design, establishment, and operation of a water supply system must be closely coordinated with the site layout, and with health and sanitation measures.

a. Evaluating Water Sources

Although estimating the immediate need for water does not require special expertise, evaluating different sources of supply does. Depending on the situation, sources of water may be identified by:

- Local government.
- Local population.
- The DPs.
- UN/PVOs/NGOs/IOs.
- An inspection of the lay of the land (ground water is often near the surface in the vicinity of rivers and in low places generally, or is indicated by richer vegetation).

- Maps and surveys of water resources.
- National and expatriate experts (hydrologists).
- Water diviners.

The evaluation of available water sources requires expertise in hydrology, engineering, and water treatment. It provides the basis for selecting an appropriate system for the selection and/or development of water sources and the distribution of water.

Seasonal factors must be carefully considered. Supplies that are adequate in the rainy season may dry up at other times. The quality of water may also change over time. Local knowledge will be essential.

b. Water System Considerations

The development and operation of the water system should include the involvement of the displaced people to the maximum extent possible. The displaced people, particularly those of rural background, may have relevant skills, such as digging and maintaining wells. Others may be familiar with simple pumps or common pump motors. Such skills can and should be fully used in planning, developing, operating, sustaining, and repairing the water system. Displaced people without prior experience should be trained as necessary.

Although special equipment may be required for ground water exploration or surface water treatment, efforts should be made to establish a water supply system with materials and equipment found locally. The chosen technology should be kept simple and appropriate to the area and should draw on local experience. Where mechanical equipment is unavoidable, pumps and supplies should be standardized, and repair expertise and fuel should be available locally.

For a water system to remain effective, both the organizational and technical aspects of the complete water supply system need to be carefully monitored. System use must be regulated, water wastage and contamination minimized, maintenance assured, and technical breakdowns quickly repaired. Basic public health education on such topics as the importance of avoiding polluting the water with excreta and the use of clean containers in the home is essential.

2. Determining Water Needs

a. Quantity

Minimum water needs vary with each situation but increase markedly with higher air temperatures and increased physical activity. In general, the following quantities of water will meet minimum needs.

Simplified table of basic survival water needs		
Survival needs: water intake (drinking and food)	3 liters per day	Depends on the climate and individual physiology
Basic hygiene practices	6 liters per day	Depends on social and cultural norms
Basic cooking needs	6 liters per day	Depends on food type and social, as well as cultural, norms
Total individual water needs	15 liters per day	

Feeding Centers	30 L/inpatient/day
Health Centers	40–60 L/inpatient/day

Table III-1 contains figures on the water needs of large groups of DPs. Additional water may be needed for livestock, sanitation facilities, other community services, and irrigation. Cattle need 20–40 L of water daily; donkeys, mules, and horses need 10–40 L; camels need 15–50 L; and small stock require 5 L. Water will also be a factor in deciding on a sanitation system and will influence the design of latrines, clothes, washing and bathing areas, and drainage ditches. Water may also be needed for the irrigation of food crops by the displaced people. During the initial stages of an emergency, wastewater may be the only type of water available for irrigation, but it can often suffice for small vegetable patches if appropriate health-related precautions are considered. Large-scale irrigation is a matter for expert advice and therefore not addressed here. If possible, however, water sources for large-scale irrigation should be identified at an early stage.

Care should be taken to avoid pollution or depletion of scarce water sources by livestock; the more accessible the supply, the greater the consumption by animals.

Table III-1. Water Needs for Displaced People (in mL)

Population	Time (Days)						
	1	30	60	90	120	180	365
500	0.0075	0.225	0.45	0.675	0.9	1.35	2.738
1,000	0.0150	0.450	0.90	1.350	1.8	2.70	5.475
5,000	0.0750	2.250	4.50	6.750	9.0	13.50	27.380
10,000	0.1500	4.500	9.00	13.500	18.0	27.00	54.750
20,000	0.3000	9.000	18.00	27.000	36.0	54.00	108.600
50,000	0.7500	22.500	45.00	67.500	90.0	135.00	273.750
100,000	1.5000	45.000	90.00	135.000	180.0	270.00	547.500
500,000	7.5000	225.000	450.00	675.000	900.0	1,350.00	2,737.500
1,000,000	15.0000	450.000	900.00	1,350.000	1,800.0	2,700.00	5,475.000

Formula: 15 L per person per day x no. of people x days = L

An insufficient quantity of water can have many health consequences. Proper supplementary and therapeutic feeding programs are impossible unless sufficient water is available for preparation of food and basic hygiene. When supplies diminish, clothes cannot be washed, personal hygiene suffers, cooking utensils cannot be properly cleaned, food cannot be adequately prepared, and in most extreme cases, the direct intake of water becomes insufficient to replace fluids lost from the body. Severe water reduction is also associated with an increased incidence of diarrheal diseases and the sometimes fatal dehydration associated with them; parasitic, fungal, and other skin diseases; and eye infections. Even individuals who have traditionally lived on less than the normally recommended amount of water, such as nomads, will require more in a DP community because of crowding and other environmental factors.

b. Quality

Water must be safe to drink. Although water may look safe, it may be polluted and contain microbiological organisms, or pathogens, that cause diseases.

Diseases transmitted by the fecal-oral route may be either “waterborne” or “water-washed.” Waterborne fecal-oral diseases are transmitted by drinking water contaminated by feces. Because a disease is capable of being transmitted by a waterborne route, this term does not necessarily describe its usual or only means of transmission. Water-washed fecal-oral diseases are transmitted by ingesting feces through various pathways, including food, person-to-person contact, and water contaminated with hands soiled by fecal material. Water-washed fecal-oral diseases are diseases that can be impacted by an increase in available safe water for washing and personal hygiene. Hand washing is particularly important in the prevention of water-washed fecal-oral diseases. Other water-washed diseases of significance are trachoma and various skin diseases. These diseases are not transmitted by fecal-oral routes. They are best prevented by ensuring an adequate quantity of safe water for personal hygiene.

Water used for drinking needs to be of high quality. Water used for washing or personal hygiene can be of lower quality but should be available in greater quantities. Overall, a large quantity of reasonably safe water is preferable to a smaller

amount of very pure water. The most serious threat to the safety of a water supply is contamination by human or animal feces. Protecting a water source from pollution is better than providing treatment for pathogen removal. Once contaminated, it may be difficult to adequately purify water under emergency conditions.

Where drinking water is scarce, brackish water, or even salt water, may be used for domestic hygiene.

New water supplies should be tested for microbiological contamination before use to determine the safety of the water. Existing supplies should be tested periodically, and immediately after an outbreak of any waterborne disease. In most situations, drinking water should be disinfected before distribution. Sanitary inspections of water sources are extremely important. The source of the water, protection of the water point, location of the source in relation to defecation areas, and protection of the water during transport and storage must be considered. A thorough sanitary inspection will often make it possible to determine that the water is polluted or likely to be polluted, and may make more complex bacteriological analyses unnecessary.

The most widely used microbiological tests detect fecal coliform bacteria, which are key indicators of fecal contamination. Tests for fecal coliforms can be performed in the laboratory or with portable field kits. The presence of fecal coliform bacteria indicates that the water has been contaminated by feces of humans or other warm-blooded animals. Some fecal coliform tests merely indicate the presence or absence of fecal coliform organisms. Other tests provide an indication of the concentration of fecal coliforms, expressed as the number of fecal coliforms per 100 mL of water.

Often, "*Escherichia coli* (*E. coli*)" is used interchangeably with "fecal coliforms." *E. coli* organisms represent approximately 90 percent of all fecal organisms. Testing for fecal streptococci is less frequently used as an indicator of fecal contamination.

Use table III-2 as a rough guide to the safety of potential water supplies. Sphere Guidelines, which provide minimum standards in disaster response, recommend that raw water supplies contain 10 or fewer fecal coliforms per 100 mL. As discussed below, there should not be any fecal coliforms

present in properly disinfected water supplies. In certain situations, a water source (e.g., a properly protected well) can be used with a reasonable degree of safety without disinfection. Careful consideration, however, must be given before deciding to use water sources that have not been disinfected.

Table III-2. Fecal Coliform as an Indicator of Water Quality and Safety

Fecal Coliforms per 100 mL	Risk
0–10	Reasonable quality
11–100	Polluted
101–1,000	Very polluted
More than 1,000	Grossly polluted

In cases where water is disinfected by chlorination, bacteriological testing is neither necessary nor appropriate. Chlorinated sources should be tested for the presence of residual chlorine. The presence of residual chlorine at a minimum of approximately 0.2 mg/L at the distribution point where people take water indicates that essentially all bacteria and viruses have been killed, and that the water is no longer contaminated with fecal or other organic matter. The chlorine residual should not be greater than 0.6 mg/L or the taste of the chlorine will not be acceptable. See also the section below, “Chemical Disinfection,” on the treatment of water with chemical disinfectants.

Water stored in tanks and tanker trucks should also be tested periodically. Appropriate sanitation and hygiene measures should be taken to protect the water between collection and use.

3. Immediate Response

Measures to meet short-term water emergency needs are appropriate if a longer term supply system is being developed, or pending the move of the DPs to a more suitable site. In cases in which the locally available water supply is not sufficient to meet the minimum needs of the displaced population, arrangements must be made to bring in water by truck. Where this tactic is not possible, the displaced population must be moved from the site without delay.

Although the quantity of water available may meet initial minimum needs, the quality of the water may be cause for concern as it may be contaminated. Efforts to control and manage the use of contaminated water should be arranged with the community leaders of the displaced population. Otherwise, displaced persons will use whatever water is closest, regardless of quality. Steps should be taken to prevent pollution by human or animal excreta. If the water source is a stream or river, supplies should be drawn off upstream of any point of potential contamination and the intake area protected against external pollution. In addition, areas for bathing, washing, and livestock care should be designated downstream of the settlement.

Where the source is a well or spring, it must be fenced off, covered, and controlled. Prevent the affected population from drawing water with individual containers that may contaminate the source. If possible, make immediate arrangements to store water and then to distribute it at collection points away from the source. Not only does this help avoid direct contamination, but storing water can also make water safer over time as well as facilitate chlorination before distribution.

At the household level, families will need to carry and store their own water. Suitable containers (10–20 L) are essential. If families do not have their own water containers, supply buckets, jerricans, or other suitable containers. Containers must be kept clean. Narrow-mouthed containers are desirable because they discourage the dipping of hands and utensils in the container and thereby minimize the potential for contamination.

When water supplies are insufficient to meet the need, priority should be given to rationing and ensuring equitable distribution of water. Rationing is difficult to organize. The first step is to control access to sources, using full-time watchmen if necessary. Uncontrolled distributions are open to abuse. Distribution at fixed times for different sections of the camp should be organized. Vulnerable groups may need special arrangements. Every effort should be made to increase the quantity of water available so that strict rationing is unnecessary.

4. Water Source

a. *Freshwater Sources*

Fresh water comes from three main sources: surface water (streams, rivers, lakes), ground water (underground or emerging from springs), and rainwater.

(1) Surface Water

Surface water is collected directly from streams, rivers, lakes, dam outflows, reservoirs, and ponds. Where such a source holds water year-round, the water table in the vicinity can be expected to be near the surface. Surface water should always be considered microbiologically unsafe unless proven otherwise and therefore is likely to require treatment measures before it can be used. Direct access may also cause difficulties with the local population. Using ground water that has passed through the natural filter of the soil is preferable to collecting surface water. If the soil is not sufficiently permeable to allow extraction of sufficient quantities of water from shallow wells, boreholes, or springs, however, surface water may be the only option. In such circumstances, emergency treatment measures such as storage, sand filtration, and chlorination are advised. Control of access to surface water is essential.

(2) Ground Water

Springs are excellent sources of ground water. Spring water is often safe at the source and can be piped to storage and distribution points. Spring water should be collected above the camp, if possible. Care should be taken to check the origin of spring water, as some springs may be nothing more than surface water that has seeped or flowed into the ground a short distance away. The source, or the point at which the spring water flows to the surface, must be protected against pollution. A simple structure of stone or concrete should be constructed at the source to allow the water to flow freely from a pipe into a tank or other collection vessel. Care must also be taken to prevent contamination in the catchment area above the source. The quantity of water supplied from a spring may vary widely with the seasons, with minimum flows occurring at the end of the dry season.

Another desirable option is to supply ground water by means of drilled boreholes or hand-dug wells. Ground water, being naturally filtered as it flows underground, is usually microbiologically pure unless polluted surface water has infiltrated the supply. The choice of method to raise ground water will depend on the depth to the water table, yield, soil conditions, and availability of expertise and equipment. Table III-3 and figure III-1 provide additional information on several methods of digging or drilling wells.

Even though wells are often used to access ground water, they have several disadvantages. Without good ground water surveys, preliminary test drilling, or clear local evidence from nearby existing wells, no guarantee warrants that new wells will yield adequate supplies of good quality water. Drilling or digging wells can also be expensive. A hydrogeological survey must be undertaken before starting any extensive drilling program. For these and other reasons, attempting to improve or rehabilitate an existing well is sometimes better than constructing a new one.

Drilled boreholes, hand-dug wells, and pumps must be disinfected immediately after construction, repair, or installation of equipment, as they normally become contaminated during the improvement work. In addition, boreholes and wells must also be protected from pollution. Open wells are especially vulnerable to contamination caused by surface water inflow and unsanitary ropes and buckets. Wells should be protected through the installation of a hand pump if feasible. Wells and boreholes should be constructed so that surface water, seasonal rain, or flood water will drain away from the wellhead. Wellheads should be located above and at least 30 to 50 meters away from any sanitation facilities and their discharges.

(3) Rainwater

Rainwater may be a primary source of water in areas with adequate and reliable rainfall. Reasonably pure rain water can be collected from the roofs of buildings or tents if they are clean and constructed of suitable mate-

rials. Rainwater collection, however, is not always reliable and requires large rooftop areas as well as individual household storage facilities, making it generally impractical for many DP emergencies. Nevertheless, every effort should be made to collect rainwater. Small collection systems using local earthenware pots under individual roofs and gutters, for example, should be encouraged. Allow the first rain after a long dry spell to run off; this washes away the accumulations of dust, sediment, and bird droppings.

b. Seawater

Seawater can be used for almost everything but drinking and cooking, thus reducing freshwater requirements.

c. Water Source Considerations

Consider the following when selecting an appropriate water source:

- Volume of supply.
- Reliability of supply (taking into account seasonal variations and extraction methods).
- Water purity, risk of contamination, and ease of required treatment.
- Speed with which the source can be made operational.
- Rights and welfare of local population.
- Appropriate technology and ease of maintenance.
- Cost.

Table III-3. Characteristics of Different Types of Well Construction

Well Type/Approximate Maximum Depth	Technique and Comments
Driven tube well/10–15 m	Special small-tipped pipe is hammered into ground. Can be sunk in 1–2 days. Needs special filter “well point” at top of the pipe. Can’t be sunk in heavy clay Soil or rock.
Auger-bored tube well/25 m	Hole bored by hand using a suitable auger for soil. Can be sunk in 2–3 days. May need imported augers but locally available boring tools can often be used.
Hand-dug well/30–40 m	Requires skilled workers; otherwise dangerous. Speed depends on soil conditions: 210 m per week for a team of 4–8. Easily contaminated by misuse or poor workmanship.
Jetted tube well/80 m	Water (high volume) is pumped down the well pipe to loosen and carry solid soil back up out of the hole, enabling the pipe to be driven deeper. Usually requires special skills and drilling equipment.
Drilled tube well (borehole)/>100 m	Large mechanized drilling rig requiring skilled operators, logistical support, and equipment and supplies for the rig. Several days to dig depending on soil and rock conditions.

Note: The yield potential of a well depends on the geological formation where the well is positioned, the contours and gradients of the land, and the well construction. Up to the limits of the aquifer’s safe yield, actual output depends on the pump. If wells are sited too close together, yields will be reduced. If too many wells are developed in a given area, long-term yields of the aquifer may be adversely impacted.

Figure III-1. Methods of Well Construction

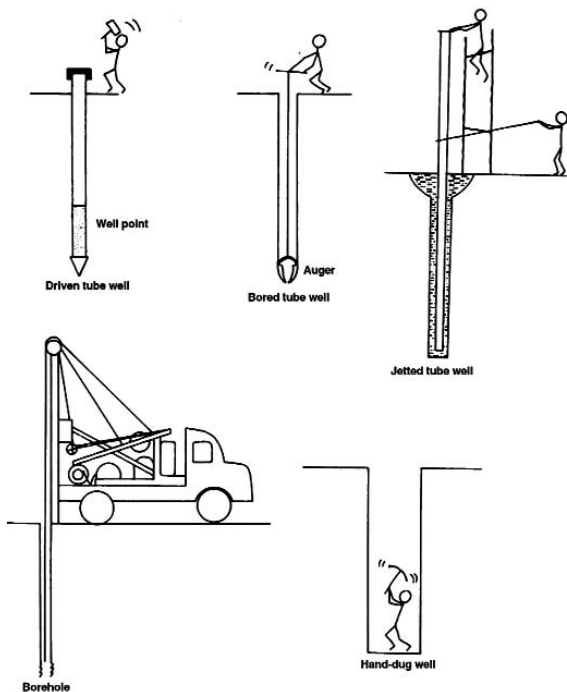

Note carefully the systems and methods already in use. Adopting well-proven and familiar techniques, combined with efforts to improve protection against pollution, is often the most appropriate solution.

In addition to organizational measures to protect the water supply, some form of disinfection will often be necessary. The purification of unsafe water, particularly in remote areas, can be difficult and requires trained supervision, but is often unavoidable if a safe supply is to be provided. Most surface water sources cannot be used safely without treatment. Untreated open wells are not safe. Covered, protected wells with hand pumps or mechanical pumps are considered safe unless proven otherwise, and can

often be used without disinfection, as can many adequately protected springs. As noted previously, a water source must be carefully evaluated before a decision is made to use the source without disinfection. Obtaining the advice of an expert is recommended.

5. Storage

As soon as practicable, displaced person camps should be provided with facilities to store an adequate reserve of water. In nearly all systems, it will be necessary to store water in covered tanks between the source and distribution points to provide an essential reserve and to facilitate distribution. Storage tanks ideally should have the capacity to store an amount of water equal to at least 1 day's consumption, thus providing a reasonable reserve capacity with the added benefit of allowing sediment to settle overnight. The size of the tank will depend on the number of people, the nature of the water supply system, and certain logistical issues. Using internal dimensions and overflow pipe heights, capacities are calculated as follows.

- Rectangular tanks:
length x breadth x height (in meters) x 1,000 = capacity in L
- Cylindrical tanks:
height x (radius squared (in meters) x 3.14) = capacity in L

OFDA stockpiles include 10,000-liter water bladders with tap stands, portable water treatment units, and 10-liter collapsible water containers. See appendix B for more information on OFDA stockpile commodities.

In areas with pronounced dry and rainy seasons where alternative sources of water are limited, the construction of in-ground reservoirs to collect water should be considered. An erosion-protected spillway should be provided. Catchment tanks for the collection of rainwater and surface runoff can also be considered in drier parts of the world. Pits can be dug into the ground to catch and hold water that runs off hard ground during heavy storms. Reservoirs, tanks, and pits need special synthetic or clay linings to hold water, and should be covered if possible. Treatment of the water collected in such structures will be required in most instances. Protection from pollution and issues related to potential mosquito breeding in malarious areas must be given careful consideration.

6. Distribution

Water distribution is an important consideration in camp layouts because displaced persons must have easy and safe, but controlled, access to water. Ideally, no camp dwelling should be located further than 500 m according to the Sphere guidelines, or a few minutes' walk from a distribution point. Greater distances may be acceptable in rural displaced person settlements. When people are required to walk long distances for water, they tend either to reduce their water usage or collect water from closer, but contaminated, sources. Both actions have a negative impact on public health. Distribution points should not be located in low-lying areas that have poor drainage and may flood during rains. The area around the distribution point should be paved with stones or gravel or protected by boards, with a runoff channel to allow proper drainage.

Water can be distributed to individuals in a number of ways depending on local conditions. Uncontrolled access by individual consumers to primary water sources must be avoided. A distribution system should have an even coverage among the camp population and a sufficient number of taps or faucets relative to the size of the population to ensure that people do not wait for long periods. Equity in the distribution of water is an extremely important consideration. Water for domestic use should flow between the source/storage and distribution points in properly engineered pipelines to protect its quality. Pipes and joints must be watertight as leaking pipes may be subject to contamination from polluted water when the pressure drops or when the system is turned off. Pipes may be made of metal, cement, plastic, or bamboo. Plastic and galvanized steel are the most common pipe materials. Plastic pipes are often the cheapest and easiest to lay and are not subject to corrosion. They are available in both sections of coiled, flexible pipe and in rigid lengths of pipe. Pipe should be buried for protection, and sections of the system should have isolation valves to facilitate repairs if breakages occur.

Public tap stands with self-closing taps are recommended as water distribution outlets. Taps, however, are very vulnerable to breakage, wear out quickly, and require a preventive maintenance program to minimize water wastage. Where water quantities are limited and must be rationed, standpipe taps that can be locked at certain times are one way to prevent people from taking more water than they are entitled to have. According to Sphere

guidelines, there should be one tap per 250 displaced persons (based on a flow of 7.5 liters/minute). Another Sphere recommendation is 500 people per hand pump (based on a flow of 16.6 liters/minute).

A certain amount of wastewater from bathing, kitchen, and laundry activities will be generated in the community, both at the individual and community level. This “greywater” can pose a danger to public health if not properly disposed of in a soakage pit, or allowed to drain away from the settlement. In some cases and with certain precautions, greywater may be reused for vegetable gardens or to flush latrines.

7. Treatment

Water may contain pathogens, particularly certain viruses, bacteria, protozoal cysts, and worm eggs. These organisms may be transmitted to water by feces, and may be ingested when water is consumed, potentially causing disease. Although water contamination by human feces is the major concern, animal feces in water may also transmit disease. Water contamination by human urine is a significant threat only in areas where typhoid and urinary schistosomiasis (*Schistosoma haematobium*) are endemic. By far the greatest risk associated with polluted drinking water is infection with a variety of organisms that cause diarrheal diseases, as well as typhoid and infectious hepatitis (hepatitis A). Diarrheal diseases are caused by a variety of viruses, bacteria, and protozoa. The numbers of viruses and protozoa in water will always decrease over time, with the most rapid decrease occurring at warm temperatures. Bacteria behave similarly, but in exceptional circumstances they may multiply in polluted water. The infectious dose of viruses and protozoa is typically very low, whereas the dose of bacteria needed to establish an infection in the intestine may be high, as in the case of cholera, or extremely low, as in the case of the shigella dysentery organism.

Determining how to treat water on a large scale is best done by experts. Simple and practical measures, however, can be taken before such help is available. All methods require regular attention and maintenance.

In addition to protecting water at its source, five basic methods can be used for water treatment: storage, sand filtration, coagulation and flocculation, chemical disinfection, and boiling. These methods can be used singly or in combination.

a. Storage

Leaving water undisturbed in containers, tanks, or reservoirs improves its quality over time. Storage allows pathogens to die off and suspended particles to settle through sedimentation. If water supplies are unsafe and cannot be easily treated, immediate action must be taken to provide maximum water storage capacity. Storage of untreated surface water for 12 to 24 hours will considerably improve its quality; the longer the period of storage and the higher the temperature, the greater the improvement. In addition, the clarification of turbid or cloudy water can be greatly speeded by the addition of aluminum sulfate (alum). A two-tank system is often used, with the first tank used as a settling tank and the second used to store the clarified water. Further treatment can be done in the second tank as well, and a third tank used for storage, if necessary. While clear water may only require chlorination, turbid surface water will usually require sedimentation and/or filtration before chlorination. Organic matter that causes turbidity reduces the effectiveness of chlorine by reacting with and dissipating chlorine, and also makes it much more difficult for chlorine to maintain necessary contact with microorganisms.

Great care should be taken to prevent the pollution of stored water. This task can be done by covering storage tanks and screening all inlets into them. In addition, the area where storage tanks are located should be fenced off and guarded to prevent children from playing or swimming in the tanks.

b. Sand Filtration

Sand filtration can also be an effective method of treatment. Rapid sand filters, which are suitable for low turbidity waters, operate either by gravity flow or within enclosed pressure vessels. Both methods employ relatively complex backwashing operations to remove suspended particles captured on the filters. A more suitable system for DP camps and rural settlements is the slow sand filter, which develops a thin biologic slime, or "schmutzdecke," on the surface of a sand bed. The schmutzdecke breaks down a large percentage of the bacteria, viruses, and protozoans found in polluted waters, while the sand layers filter out additional organisms, along with suspended sediments and particulate matter. The rate of filtration through a slow sand filter depends on the

surface area, depth, and type of sand through which the water is passed, and the pressure of the water. The average size of sand particles is 0.3–1.0 mm. In general, the slower the rate of filtration, the higher the quality of the water.

A packed drum filter can be used for sand filtration and is a good way of providing limited quantities of safe water quickly (e.g., for a health center). In a packed drum, filter water passes down through layers of sand and gravel and is drawn off at a rate not to exceed 60 L per hour for a 200-L drum. Unfiltered water equal to the amount drawn off is continually added to the top of the drum. Other types of sand filters include horizontal sand filters and riverbed filters (suitable only where the riverbed is permeable). These methods can be used to treat larger amounts of water but are likely to be more difficult to set up quickly and effectively. To filter water from a river, a well may be dug close to the bank. This water must still be considered river water, and though it will have been filtered through the bed and bank, further treatment may be necessary (e.g., chlorination).

c. *Coagulation and Flocculation*

Because chlorine and other forms of chemical disinfection do not work well in highly turbid waters, coagulation and flocculation is used to clarify water through the addition of aluminum sulfate (alum). The alum chemically coagulates the turbidity in the water. Over time, particles begin to stick together in the flocculation process, eventually forming clusters of larger particles that are removed by sedimentation and/or filtration. Coagulation is most effective at pH ranges of 5 to 8.

d. *Chemical Disinfection*

Chemical disinfection kills pathogenic organisms and is the final stage in the water treatment process. This type of disinfection is most effective when used to purify relatively clear water or to disinfect wells, sand filters, pumps, and piped water systems. Various forms of chlorine can be used as well as iodine, although chlorine is more widely used, cheaper, and often more readily available. The most generally suitable form of chlorine for DP emergencies is calcium hypochlorite powder, which contains 60 to 70 percent available chlorine (the chlorine that remains in water after chemical reactions between the chlorine and the water have

occurred). Chlorine tablets are also used in some instances. Sodium hypochlorite (e.g., bleach) in liquid form containing approximate 5 percent available chlorine is also used in many situations. Chlorine gas, which is normally used in large conventional water treatment systems, is highly corrosive and should not be used in emergency situations except under extremely unusual circumstances.

Expert advice is essential for large-scale chlorination, and all systems using chlorine products must be given close attention and regular maintenance. Chlorination generally occurs after sedimentation and filtration, if these processes are needed. At least 30 minutes contact time is needed for chlorine to react with and kill microorganisms.

Water should be tested for chlorine residual levels after each disinfection and before distribution. A pocket-size chlorine test kit is used to test for chlorine residual levels.

After chlorination, there should be at least 0.2 mg/L (or parts per million) of residual chlorine (free available chlorine) in the water to ensure that all bacteria and viruses have been killed, as well as to safeguard against subsequent contamination. Chlorine should be added to the water until the free available chlorine reaches approximately 0.5 mg/L. Highly polluted waters will require greater doses of chlorine than relatively clean waters. The amount of free available chlorine remaining in the water should be no more than 0.6 mg/L to minimize unpleasant taste. If the amount of free available chlorine is above 1.0 mg/L at the distribution point, the water will have a distinct chlorine taste and most people will not want to drink the water.

Chlorine and iodine water purification tablets are available, and are sometimes distributed to DPs for water treatment in the home, but rarely are suitable to treat water for large populations. Tablets, however, may be useful to treat water in health facilities or supplementary feeding centers. Certain new technologies for home-based water treatment such as individual bottles of chlorine, individual packets that both flocculate and disinfect water and small portable filtration units are currently being used on a limited basis, and are under investigation and trial application to evaluate their suitability for emergency use. These technologies may prove

useful in specific emergency situations and may be used in the future. The biggest obstacle to their effective use is the difficulty of implementing programs requiring substantial change in human behavior during acute stages of emergencies. Such products may be more suitable for use during more stable situations.

e. Boiling

Boiling is the surest and perhaps simplest method of water sterilization but is practical only for small displaced populations. At low altitudes, bringing water to a boil for 1 minute will essentially destroy all pathogens transmitted by drinking water. Boiling times, however, must be increased by 1 minute for every 1,000 m of altitude above sea level, as the temperature at which water boils decreases with altitude. To improve taste, allow the water to cool, and then pour the water from one clean container to another several times. Boiling increases the concentration of nitrates, which are dangerous for very young babies. Care must be taken not to use the boiling option for babies' drinking water when using groundwater sources that potentially contain elevated nitrate levels. Prolonged vigorous boiling is often recommended but not necessary to destroy fecal-oral transmitted pathogens. Prolonged boiling is not only unnecessary, but it also wastes fuel. In general, boiling is not suitable for camp situations if the energy source is firewood, which is likely to be in short supply. The availability of domestic fuel supplies may be the determining factor, as boiling requires about 1 kg of wood per liter of water. If the displaced people have traditionally boiled their water, however, they should be encouraged to do so. This may make the need for other types of water treatment less urgent.

D. Food and Nutrition

1. Basic Facts About Food and Nutrition

a. Nutrients

Foods are made up of five basic types of nutrients: carbohydrates, fats, proteins, vitamins, and minerals.

Carbohydrates are a source of energy and consist mostly of starches and sugars of vegetable origin, such as cereals and tubers. **Fats and oils** provide the most concentrated

source of energy, having more than twice the energy content per weight of carbohydrates and proteins. In most poor countries, most energy is derived from staple foods, especially cereals, with fats accounting for a much smaller portion. **Proteins** are bodybuilding substances required for growth and tissue repair. Protein is found in foods of animal origin, cereals, and legumes. **Vitamins and minerals** are needed in small quantities for the adequate functioning of the body. Individual vitamins and minerals or combinations are found in all foods in variable amounts.

b. Energy and Protein Intakes

If the energy intake is inadequate, some protein in the body will burn to provide energy instead of promoting body growth or repair. That is, it will be used in the same way as carbohydrates or fats. No less than 10 percent of the energy requirement should be supplied from fats and oils. They also greatly enhance the palatability of the diet and increase energy density, which is important for younger children. Energy requirements vary widely, even among normal individuals, and increase with physical activity. Much higher intakes are required for the treatment of malnutrition, when the aim is rehabilitation rather than maintenance.

c. Food and Diets

Diets in most countries contain adequate amounts of nutrients required for good health if enough of the diet is taken to satisfy the individual's energy requirements. Even a growing, healthy child requires no more than 10 percent of the calories to be supplied from protein sources.

2. Food Security

Food security is defined as the point when all people at all times have both physical and economic access to sufficient food to meet their dietary needs for a productive and healthy life. Three distinct variables are central to the attainment of food security: availability, access, and utilization.

Food availability is achieved when sufficient quantities of food are consistently available to all individuals within a country. Such food can be supplied through household production, other domestic output, commercial imports, or food assistance.

Food access is ensured when households and all individuals within them have adequate resources to obtain appropriate foods for a nutritious diet. Access depends on income available to the household, the distribution of income within the household, and the price of food.

Food utilization is the proper biological use of food, requiring a diet providing sufficient energy and essential nutrients, potable water, adequate sanitation, and good health. Effective food utilization depends in large measure on knowledge within the household of food storage and processing techniques, basic principles of nutrition, and proper child care.

3. Malnutrition Causes and Interventions

a. *Malnutrition Causes*

The causes of malnutrition are multifaceted. Understanding these causes is critical to developing an appropriate response. High malnutrition rates are the consequence of inadequate dietary intake and/or disease. Factors contributing to inadequate dietary intake and disease can include inadequate household food security, inadequate maternal and child care, insufficient services, and an unhealthy environment. The root causes of malnutrition can ultimately be traced to the policies of broad formal and non-formal institutions, political, economic, and ideological structures, and potential resources.

If the causes of malnutrition are due to **food availability**, suggested interventions include: general food distributions; supplementary feeding programs (SFPs) to children under 5 years in age and pregnant and lactating women; community-based therapeutic programs (CTCs); and therapeutic feeding centers (TFCs). In addition, agriculture, livestock, and livelihood programs that will increase food availability must be initiated to have a long-term impact on the food security of the population.

If **food access** is causing high malnutrition rates, the type of intervention depends on the extent of the problem within the population. If the whole population does not have access to food, appropriate measures include: food for work or general food distribution; blanket supplementary feeding for the under-5 age group and pregnant and lactating women; and CTC and TFC as appropriate. If only parts of the population

do not have access to food, food distribution should be targeted to vulnerable groups, focused SFPs can be initiated (ensure that the families of children in SFP are included in the program), and CTC and TFC can be started as appropriate.

If food is available on the market, cash can be provided to families to access this food. This will keep market prices stable and protect the livelihood of food producers. A targeted SFP can be initiated (ensure that the families of these children are included in the cash program), as well as a CTC and TFC if appropriate.

If **food utilization** by the body is inadequate, programs that address water, sanitation, and health, including child feeding practices, must be initiated.

Regardless of the causes of malnutrition, the gains made by the initiation of CTC and TFC in the absence of a functional health system are short lived. The health system must be able to provide vaccinations and preventative, as well as curative, services. Water and sanitation also play a vital role in the health and nutritional status of the general population, particularly the under-5 age group.

b. Considerations in Selecting Interventions

The types of feeding programs required to meet the food security needs of the displaced people will be determined by the initial needs assessment (see chapter II). Continuous monitoring will ensure adjustments to reflect changing conditions. Coordination of the feeding programs with health and other community services is essential.

Assistance must be culturally acceptable and appropriate to the nutritional needs of the displaced people. Foods prepared locally with local ingredients are preferable to imported foods. Infant feeding policies require particular attention.

Infants, children, pregnant and lactating women, the sick, and the elderly are very vulnerable to malnutrition and have special needs. Since the population has already probably suffered a prolonged food shortage, many will be malnourished by the time of the first assessment of their condition and needs.

If the displaced people are already suffering the effects of severe food shortages, immediate action must be taken to provide whatever food is available to them. The first priority is to meet the energy requirements of the population rather than protein needs. Supplying bulk cereal is the first objective of the general feeding program.

Beneficiaries must be involved from the start in the organization and management of the feeding programs. Special training for some displaced people may be necessary.

Simple nutrition education is important when unfamiliar foods or new methods of cooking and preparation have to be introduced to the population. Nutrition education should be organized with other health education activities to provide guidance on proper infant feeding, feeding of sick children, treatment of diarrhea, basic food hygiene, and the preparation of available foods for maximum nutritional benefit.

Particular attention must be paid to the provision of cooking fuel. A lack of cooking fuel can quickly lead to destruction of the vegetation around the camp and friction with the local population. On average, a family will use 5 kg of wood per day to cook on a simple wood stove.

4. Nutritional Diseases

a. *Protein-Energy Malnutrition*

Protein-energy malnutrition (PEM) can refer to either acute or chronic malnutrition. Because children between 6 months and 5 years of age (especially at the time of weaning) are among the most acutely affected by malnutrition, assessment of this age group by physical measurement is usually done to determine PEM prevalence in a population. In general, acute malnutrition results in wasting and is assessed by an index of weight-for-height (WFH); however, edema of the extremities may also be associated with acute malnutrition, in which case a clinical assessment is necessary. Chronic malnutrition produces stunting and typically results in a diminished height-for-age index.

The prevalence of moderate to severe acute malnutrition in a random sample of children less than 5 years of age is generally a reliable indicator of this condition in a population. Because weight is more sensitive to sudden changes in

food availability than height, nutritional assessments during emergencies focus on measuring WFH. Also, WFH is a more appropriate measurement foregoing monitoring of the effectiveness of feeding programs. As a screening measurement, the mid-upper- arm-circumference (MUAC) method may also be used to assess acute malnutrition.

PEM is a problem in many developing countries, even under normal conditions. Severe PEM is usually precipitated by low food intake associated with infection. Displaced people are particularly vulnerable to PEM. PEM has three forms, which are described below.

(1) Nutritional Marasmus

The most frequent form of PEM, also known as marasmus which occurs in cases of prolonged food shortage, is a severe wasting away of body fat and muscle. Affected children become very thin, may have an “old person” face, and loose folds of skin. They may appear, however, relatively active and alert. Marasmus can be confused with dehydration; very often children suffer both. Dehydrated children appear sicker, have a very rapid pulse, usually have a fever, and are usually very thirsty.

(2) Kwashiorkor

Kwashiorkor is seen most commonly in areas where the staple food is mainly carbohydrate, such as tubers and roots like cassava. Many factors other than protein deficiency, however, precipitate this disease. The main sign of kwashiorkor is edema, a swelling that usually starts at the lower extremities and extends in more advanced cases to the arms and face. Edema must be present for the diagnosis of kwashiorkor, but edema can also occur in other diseases. Where gross edema occurs, the child may look “fat” and be regarded by the parents as well fed. To check for edema, press the area on the back of the foot; edema is indicated if the dent remains after you remove your finger (often called pitting edema). Associated signs of kwashiorkor, which do not always occur, include hair changes (color becomes lighter, curly hair becomes straight, hair comes out easily with a gentle pull) and skin changes (dark skin may become lighter in places, skin may peel off, especially on the legs, and ulcerations may occur). Children with kwashiorkor are

usually apathetic, miserable, and withdrawn, and often refuse to eat. Profound anemia is a common complication of kwashiorkor.

(3) Marasmic Kwashiorkor

Marasmic kwashiorkor is a mixed form of PEM, with edema occurring in children who are marasmic, and who may or may not have other associated signs of kwashiorkor. Mixed forms will often be seen.

b. Micronutrient Deficiency Diseases

In addition to PEM, micronutrient deficiencies play a key role in nutrition-related morbidity and mortality. Following are common micronutrient deficiencies.

(1) Vitamin A Deficiency (VAD)

The most common deficiency syndrome in displaced populations is caused by a lack of vitamin A. Vitamin A deficiency is also known as xerophthalmia. It can cause night blindness in early stages and permanent eye damage and blindness in later stages. Famine-affected and displaced populations often have low levels of dietary vitamin A intake before experiencing famine or displacement, and therefore may have very low vitamin A reserves. Furthermore, the typical rations provided in large-scale relief efforts lack vitamin A, putting these populations at high risk. In addition, some diarrheal diseases rapidly deplete vitamin A stores. Depleted vitamin A stores need to be adequately replenished during recovery from these diseases to prevent the disease from becoming worse. Vitamin A is stored in the liver, so daily doses are not necessary; after initial treatment, supplemental doses can be as much as 3 months apart.

(2) Vitamin C Deficiency (Scurvy)

Although scurvy rarely occurs in stable populations in developing countries, many outbreaks have occurred in displaced and famine-affected populations, primarily because of inadequate vitamin C in rations. Scurvy is marked by spongy gums, loosening of the teeth, and a bleeding into the skin and mucous membranes. Fortification of foods with vitamin C is problematic because vitamin C cannot be stored in the body. The best solution is to provide vitamin C through a variety of

fresh foods, either by including them in the general ration or by promoting access to local markets. In addition, local cultivation of foods containing vitamin C foods should be encouraged. Patients with clinical scurvy should be treated with 250 mg of oral vitamin C two times a week for 3 weeks.

(3) Niacin Deficiency (Pellagra)

Pellagra is caused by a severe deficiency of biologically available niacin in the diet. This disease is endemic where people eat a maize-based diet with little protein-rich food. Pellagra is characterized by dermatitis, gastrointestinal disorders, and central nervous system problems. Treatment of maize flour with lime (which converts niacin into a biologically available form of niacin) and the inclusion of beans, peanuts (ground nuts), or fortified cereals in daily rations increases the total intake of available niacin and will prevent the development of pellagra.

(4) Anemia

Anemia is caused by a lack of hemoglobin and indicates a lack of iron in the diet. Diets that are lacking in vitamin C or are high in fiber reduce iron absorption. The condition is marked by a lack of energy. Severe anemia in a displaced population can be a major cause of mortality for young children and pregnant women. Treatment for anemia includes a daily administration of iron/folate tablets and vitamin C. Supplementary feeding of high-risk groups with corn-soya milk (CSM) will also help reduce the likelihood of anemia (100 g of CSM contains 18 g of iron).

(5) Thiamine Deficiency (Beriberi)

Beriberi is caused by an inability to assimilate thiamine. It occurs where people have to exist on a starchy staple food such as cassava or polished white rice. Beriberi is characterized by inflammatory or degenerative changes of the nerves, digestive system, and heart. Sources of thiamine include dried peas and beans and whole-grain cereals. One major problem is that thiamine is destroyed during cooking.

5. Nutritional Surveillance Methods

The information in this section is designed to help Assessment Team members understand and evaluate nutritional data from surveys they may encounter in the field. It is not intended to teach them how to conduct these activities. Context-specific information is also needed in the survey to explain the rate of malnutrition. For example, if the rate of malnutrition is very high, the team should ask if a disease outbreak occurred before the date of the survey. A diarrheal disease, acute respiratory infection, or measles outbreak that occurred in the 2 weeks preceding the survey may help explain the increase in malnutrition.

Followup surveillance of the population as a whole should be done by gathering information about the nutritional status of the children, using the WFH or weight-for-length (WFL) comparison method. WFH is a lagging indicator; by the time it shows a significant change, the situation has already deteriorated. Children are the first to show signs of malnourishment during a food shortage. Their nutritional status is an indicator of the amount and degree of malnutrition in the population as a whole. Using the WFH or WFL comparison method on a random sample of children will help assess the nutritional status of the population as a whole.

When using the WFH or WFL method in a surveillance program, a random sample of children from 6 months to 59 months of age (under 5 years of age) or less than 110 cm tall are weighed and measured regularly. Children less than 85 cm tall are measured supine (WFL) and children above 85 cm tall are measured standing up (WFH). See the description of the weight-for-height (weight-for-length) method in the next section for additional information on assessing malnutrition using this method.

a. Sampling Methods

In a given population, 18 to 20 percent will be under 5 years of age. For a small displaced population (2,000 to 3,000), all the children, about 400 to 500, should be measured. For larger populations, two methods of surveillance are most applicable: systematic random sampling and cluster sampling.

(1) Systematic Random Sampling

Systematic random sampling, in which an interval of every n^{th} shelter or household is sampled and all children

under 5 years of age in that household are measured, is recommended where populations are living in an organized or structured setting as a camp. To undertake a systematic random sampling, one needs to know the total number of households, the average number of children under 5 years of age in a household, and the total population. The recommended sample size for a systematic random sampling is 500 children. This sample size will ensure 95 percent probability that the sample is representative.

To calculate the n^{th} interval, first calculate the number of households to be visited to measure 500 children. Use the following equation: $500 / (A \times P)$, where A = the average household size and P = the proportion of children under 5 years of age in the total population.

For example, if the average household size is six persons and the proportion of children under 5 years of age (110 cm in height) is 17 percent, then $500 / (6 \times 0.17) = 490$ households to be visited to measure 500 children.

If 10,000 households reside in the population, the n^{th} sampling interval would equal $10,000 / 490$ households to be visited = 20. Therefore every 20th household should be visited until 500 children under 5 years (110 cm) are measured.

(2) Cluster Sampling

Cluster sampling, in which random “clusters” of households are measured, is used in populations that are not in even or structured settings but are spread unevenly over a large geographic area. The cluster sample method is most often used because, in the initial stages of emergencies, people are rarely living in a structured pattern. The sample size needed to obtain 95-percent probability is 900 children. For reliable results, examine at least 30 clusters and not less than 900 children or “30 clusters of 30.”

In a rapid assessment, the area of interest should be divided on a map into sections of equal size. Each section should have at least 300 inhabitants. The total number of clusters, drawn from a list of all sections and their population estimates, is divided by 30 to obtain the cluster interval k . Starting at a random selected interval, every k^{th} cluster is selected. For example, suppose that

there are a total of 210 clusters. This total number of clusters is divided by 30 to obtain the cluster interval ($210 / 30 = 7$). Starting from a randomly selected cluster, every 7th cluster on the list is selected until 30 survey clusters are chosen.

During the survey, the team starts at the center of the cluster and chooses a direction (by spinning a bottle or pen). The survey is then started at the next nearest household or shelter in that direction. All eligible children in the household are measured. The team moves to successive houses until 30 children have been examined.

Pay particular attention to the geographic area or food economy groups in which people live, especially in drought emergencies. For example, if a large geographic area is inhabited by pastoralist, agropastoralist, and agriculturalist groups, a separate survey should be conducted for each group, as the effects can be quite different among these groups.

Initially, such surveys should be conducted every 2 months. When conditions have stabilized, a survey once every 3 to 6 months is sufficient. Any change or trend in nutritional status can thus be detected and adjustments made in the relevant feeding programs.

If the initial assessment indicates a need for supplementary or therapeutic feeding, individuals with these requirements should be identified and registered for appropriate programs. Their individual progress should be monitored through more frequent weighing at feeding centers.

b. Malnutrition Measurement Methods

Malnutrition can be recognized by certain clinical signs (e.g., marasmus, kwashiorkor, and marasmic-kwashiorkor) and body measurements. Body measurements are required for objective assessment of nutritional status and comparison with regular surveillance data.

Acute malnutrition is measured by the WFH method, while chronic malnutrition or stunting is measured by height for age. In many areas, the information collected at health facilities is the rate of stunting rather than acute malnutrition. OFDA's responsibility is to decrease acute malnutrition to save lives.

(1) Weight-for-Height (Weight-for-Length) Method

The weight-for-height (weight-for-length) measurement method, which is expressed either as a **percentage of a reference median** or as a **Z-Score**, is preferred for nutritional surveillance and for measuring individual progress in emergencies. If a **percentage** is used, it indicates the weight of the child expressed as a percentage of that of a well-nourished child of the same height as given in international reference tables. If a **Z-Score** is used, the “Z” represents the median for children and the Z-Score represents the number of standard deviations above or below the median (because the population is normally distributed, the median equals the population mean). Children with less than 80 percent weight-for-height or with a Z-Score of less than -2 are classified as malnourished; those with less than 70 percent weight-for-height or with a Z-Score of less than -3 are considered severely malnourished. Without special feeding programs, severely malnourished children will die.

Note that the weight-for-height method should not be used for children who have edema; they should automatically be classified as severely malnourished.

Abbreviated reference tables with weight-for-height and weight-for-length comparisons and Z-scores are located in tables III-4, III-5, III-6, and III-7.

**Table III-4. Weight-for-Length Expressed
as a Percentage of Median Weight
(length assessed supine up to 85.0 cm, sexes combined)**

Length (cm)	Median Weight (kg)	80%	75%	70%	60%
65.0	7.0	5.6	5.3	4.9	4.2
66.0	7.3	5.9	5.5	5.1	4.4
67.0	7.6	6.1	5.7	5.3	4.6
68.0	7.9	6.3	5.9	5.5	4.7
69.0	8.2	6.6	6.1	5.7	4.9
70.0	8.5	6.8	6.3	5.9	5.1
71.0	8.7	7.0	6.5	6.1	5.2
72.0	9.0	7.2	6.7	6.3	5.4
73.0	9.2	7.4	6.9	6.5	5.5
74.0	9.5	7.6	7.1	6.6	5.7
75.0	9.7	7.8	7.3	6.8	5.8
76.0	9.9	7.9	7.4	6.9	5.9
77.0	10.1	8.1	7.6	7.1	6.1
78.0	10.4	8.3	7.8	7.2	6.2
79.0	10.6	8.4	7.9	7.4	6.4
80.0	10.8	8.6	8.1	7.5	6.5
81.0	11.0	8.8	8.2	7.7	6.6
82.0	11.2	8.9	8.4	7.8	6.7
83.0	11.4	9.1	8.5	7.9	6.8
84.0	11.5	9.2	8.7	8.1	6.9

**Table III-5. Weight-for-Height Expressed
as a Percentage of Median Weight
(height assessed by standing from 85.0 cm, sexes combined)**

Length (cm)	Median Weight (kg)	80%	75%	70%	60%
85.0	12.0	9.5	9.0	8.4	7.2
86.0	12.2	9.8	9.1	8.5	7.3
87.0	12.4	9.9	9.3	8.7	7.4
88.0	12.6	10.1	9.5	8.8	7.6
89.0	12.9	10.3	9.7	9.0	7.7
90.0	13.1	10.5	9.8	9.2	7.8
91.0	13.3	10.7	10.0	9.3	8.0
92.0	13.6	10.8	10.2	9.5	8.1
93.0	13.8	11.0	10.3	9.7	8.3
94.0	14.0	11.2	10.5	9.8	8.4
95.0	14.3	11.4	10.7	10.0	8.7
96.0	14.5	11.6	10.9	10.2	8.7
97.0	14.8	11.8	11.1	10.3	8.9
98.0	15.0	12.0	11.3	10.5	9.0
99.0	15.3	12.2	11.5	10.7	9.2
100.0	15.6	12.4	11.7	10.9	9.3
101.0	15.8	12.7	11.9	11.1	9.5
102.0	16.1	12.9	12.1	11.3	9.7
103.0	16.4	13.1	12.3	11.5	9.8
104.0	16.7	13.3	12.5	11.7	10.0
105.0	16.9	13.6	12.7	11.9	10.1
106.0	17.2	13.8	12.9	12.1	10.3
107.0	17.5	14.0	13.1	12.3	10.5
108.0	17.8	14.3	13.4	12.5	10.7
109.0	18.1	14.5	13.6	12.7	10.9
110.0	18.4	14.8	13.8	12.9	11.0

**Table III-6. Weight-for-Length and Associated Z-Scores
(length assessed supine up to 85.0 cm, sexes combined)**

Length (cm)	Median Weight (kg)	- 2 Z	- 3 Z
65	7.0	5.6	4.9
66	7.3	5.9	5.2
67	7.6	6.1	5.4
68	7.9	6.4	5.7
69	8.2	6.7	5.9
70	8.5	6.9	6.1
71	8.7	7.2	6.4
72	9.0	7.4	6.6
73	9.2	7.6	6.8
74	9.5	7.8	7.0
75	9.7	8.1	7.2
76	9.9	8.3	7.4
77	10.1	8.5	7.6
78	10.4	8.6	7.8
79	10.6	8.8	8.0
80	10.8	9.0	8.1
81	11.0	9.2	7.4
82	11.2	9.4	8.5
83	11.4	9.6	7.8
84	11.5	9.7	8.8

**Table III-7. Weight-for-Height and Associated Z-Scores
(height assessed by standing from 85.0 cm, sexes combined)**

Length (cm)	Median Weight (kg)	- 2 Z	- 3 Z
85.0	12.0	9.8	8.7
86.0	12.2	10.0	8.9
87.0	12.4	10.2	9.1
88.0	12.6	10.4	9.3
89.0	12.9	10.6	9.5
90.0	13.1	10.8	9.6
91.0	13.3	11.0	9.8
92.0	13.6	11.2	10.0
93.0	13.8	11.4	10.2
94.0	14.0	11.6	10.4
95.0	14.3	11.8	10.5
96.0	14.5	12.0	10.7
97.0	14.8	12.2	10.9
98.0	15.0	12.4	11.1
99.0	15.3	12.6	11.3
100.0	15.6	12.8	11.5
101.0	15.8	13.0	11.7
102.0	16.1	13.3	11.9
103.0	16.4	13.5	12.1
104.0	16.7	13.7	12.3
105.0	16.9	14.0	12.5
106.0	17.2	14.2	12.7
107.0	17.5	14.5	12.9
108.0	17.8	14.7	13.2
109.0	18.1	15.0	13.4
110.0	18.4	15.2	13.6

(2) MUAC Method

Another method used when a rapid screening of young children is necessary is the MUAC measurement. This measurement is less precise than the WFH method but can be done more quickly. MUAC is an indicator of the risk of death rather than malnutrition. It can be used in insecure areas where access to the vulnerable population is very limited. MUAC measures the part of the arm where the circumference does not normally change significantly between the ages of 1 and 5, but wastes rapidly with malnutrition. The technique is not suitable for monitoring the progress of individual children. Professional help should be used for the MUAC method.

If the child has no signs of edema, the MUAC of the child should be measured, using a measuring tape specifically designed for MUAC measurements. The tape should be wrapped closely, but not tightly, around the arm, midway between the elbow and the point of the shoulder. The arm should be hanging loosely, with the tape measure circled around the arm. The tip of the tape measure should be inserted back-to-front through the narrow slit at the white end of the tape. The arm circumference should be read to the nearest 0.1 cm between the vertical arrows at the center of the large opening. The arm circumference of normal children between 1 and 5 years of age changes very little. Therefore, children of these ages can be included in a nutrition survey using the same standards.

The arm circumference tapes have colored bands representing the different nutritional states below.

Status	Arm circumference	Color
Normal	13.5 cm or greater	Green
Mild malnutrition	12.5 to 13.4 cm	Yellow
Moderate to severe malnutrition	Less than 12.5 cm	Red

If custom-made measuring tapes are not available, a thin strip of plastic (about 30 cm in length) should be used with marks clearly indicated at the zero point, 12.0 cm, 12.5 cm, and 13.5 cm.

Each arm circumference has an approximate equivalent to a WFH percentage.

- 13.5 cm or greater: approximately equivalent to more than 85 percent WFH.
- 12.5 to 13.4 cm: approximately equivalent to 80 to 85 percent WFH.
- Less than 12.5 cm: approximately equivalent to less than 80 percent WFH.

The amount and degree of malnutrition can be calculated as percentages of the sample. The percentage of children with edema (kwashiorkor) should also be reported.

The child should be checked for edema, the swelling associated with kwashiorkor, before being measured using either the WFH or MUAC method. Press a finger against the front of the child's foot for about 3 seconds. A dent (pitting) indicates that the child has edema and therefore should not be measured. It should be recorded that the child has edema and is severely malnourished.

(3) Interpretation of Malnutrition Rates and Corresponding Actions

Finding	Action required
Malnutrition rate ^a 15% or more or 10-14% with aggravating factors ^b	Serious situation <ul style="list-style-type: none"> • General rations (unless situation is limited to vulnerable groups); plus • Supplementary feeding generalized for all members of vulnerable groups, especially children and pregnant and lactating women • Therapeutic feeding program for severely malnourished individuals
Malnutrition rate ^a 10-14% or more or 5-9% with aggravating factors ^b	Risky situation <ul style="list-style-type: none"> • No general rations; but • Supplementary feeding targeted to individuals identified as malnourished in vulnerable groups • Therapeutic feeding program for severely malnourished individuals

Finding	Action required
Malnutrition rate ^a under 10% with no aggravating factors	Acceptable situation <ul style="list-style-type: none"> • No need for population interventions • Attention for malnourished individuals through regular community services

^a Malnutrition rate is defined as the percentage of the child population (6 months to 5 years) who are below either the reference median WFH – 2 SD or 80% of reference WFH.

^b Aggravating factors:

- General food ration below the mean energy requirement
- Crude mortality rate more than 1 per 10,000 per day
- Epidemic of measles or whooping cough (pertussis)
- High incidence of respiratory or diarrheal diseases

6. General Feeding Programs

Every effort should be made to provide familiar foodstuffs and to maintain sound traditional food habits. Expert advice on the appropriate food ration is essential and should take full account of local availability. Staple foodstuffs should not be changed simply because unfamiliar substitutes are readily available. Providing unfamiliar foods often leads to wastage and malnutrition and lowers the morale of the population.

The amount and quality of food provided must satisfy daily energy and protein requirements. A Survival Ration should provide at least 2,100 kcal (and 60 g of protein) per person per day. This is based on the Institute of Medicine's 1995 report on Estimated Mean per Capita Energy Requirements for Planning Emergency Rations. Active adults may require considerably higher energy intakes, especially if part of the relief plan includes a Food-for-Work Program. Although a marked difference exists between the needs of a young child and an active adult, providing a standard ration for each DP without distinction is strongly recommended. **A typical daily ration providing sufficient calories and protein should include selections from each of the following categories of food.**

Food category	Example	Daily ration (g)
A staple food that provides the bulk of the energy and protein requirement	Cereal	400–450
An energy-rich food	Vegetable oil	20–30
A protein-rich food	Pulses	30–60

Fortified foods may also assist meeting micronutrient needs but should be combined with local foods and supplements.

Tables III-8 and III-9 provide information on examples of food rations in protracted crisis situations and planning figures to determine bulk food requirements during these situations.

If grains must be milled, the amount of food provided for rations must be increased, as a portion must be given to the miller and because of loss during milling. Vitamin B is lost in the milling process.

Other items such as vegetables, sugar, spices, condiments, fruits, and tea should be provided according to cultural and nutritional needs, if possible. Absolute priority, however, must be given to the delivery of the staple food. The regular delivery of a few staple items is better than an unpredictable delivery of hard-to-find items.

Essential vitamin and mineral requirements must also be met. Where adequate quantities of certain nutrients cannot be provided in the diet, the inclusion of seasonally available vegetables will usually prevent vitamin and mineral deficiencies. When possible, the population should be encouraged to grow gardens of vegetables for personal use or purchase vegetables at local food markets.

Particular attention must be paid to vitamin and mineral deficiencies. Two deficiencies are commonly seen among displaced people: vitamin A deficiency and anemia. Vitamin A deficiency in malnourished populations, especially children, leads to increased morbidity, blindness, and death. Anemia is commonly associated with certain parasitic diseases such as schistosomiasis and hookworm or an insufficient intake of iron and folate. In the most severe cases, anemia can lead to cardiac failure and death. Both deficiencies are preventable with a proper diet. Efforts must be made to include food items that are rich in the

needed nutrients. The distribution of multivitamin tablets to the entire population may be useful to prevent some deficiencies but is expensive, labor intensive, and not effective for all deficiencies.

Table III-8. Examples of Food Survival Rations for Populations in Protracted Crisis Situations (quantity in g, based on 2,100 kcal/person/day)

Commodities	Ration Option 1	Ration Option 2	Ration Option 3
Rice/wheat flour/cornmeal	430	430	430
Pulses (beans/peas)	45	0	0
Pulses (lentils)	0	30	0
Vegetable oil	25	25	25
Corn-soya blend	35	0	35
Wheat-soya blend	0	35	0
Canned fish	0	0	30
Sugar	0	15	15
Salt (iodized)	5	5	5
Total	540	540	540
Approximate Food Value			
Energy (kcal)	2,100	2,100	2,100
Protein (g)	50	60	50
Fat (g)	30	30	30

Note: Fresh fruits and vegetables, cereals and legumes, and condiments or spices should be made available whenever possible. Fortified cereal blends, such as wheat-soya blend and corn-soya blend, are good sources of micronutrients. The addition of quantities of various micronutrients, through the inclusion of such fortified cereals and local fresh foods, is highly desirable.

Table III-9. Examples of Planning Figures To Determine Food Needs for Survival Food Rations for Population in Protracted Crisis Situations (food quantity in metric tons, based on 540 g/person/day [2,100 kcal option])

Population	Time (Days)						
	1	30	60	90	120	180	365
250	0.135	4.05	8.1	12.15	16.2	24.3	49.275
500	0.270	8.10	16.2	24.30	32.4	48.6	98.550
1,000	0.540	16.20	32.4	48.60	64.8	97.2	197.100
5,000	2.700	81.00	162.0	243.00	324.0	486.0	985.500
10,000	5.400	162.00	324.0	486.00	648.0	972.0	1,971.000
20,000	10.800	324.00	648.0	972.00	1,296.0	1,944.0	3,942.000
50,000	27.000	810.00	1,620.0	2,430.00	3,240.0	4,860.0	9,855.000
100,000	54.000	1,620.00	3,240.0	4,860.00	6,480.0	9,720.0	19,710.000
500,000	270.000	8,100.00	16,200.0	24,300.00	32,400.0	48,600.0	98,550.000
1,000,000	540.000	16,200.05	32,400.0	48,600.00	64,800.0	97,200.0	197,100.000

Formula: Number of persons per day _ .540 / 1,000 kg

Vitamin A, however, should be given once every 4 months to children under 5 years of age. Infants less than 6 months should receive no vitamin A because of possible toxicity. Infants from 6 to 11 months should receive the equivalent of 100,000 international units (usually half of a capsule). Children from 1 to 5 years of age should receive the equivalent of 200,000 international units (usually one capsule). Women of reproductive age should not receive concentrated doses of vitamin A. Women should receive vitamin A through other strategies mentioned above such as vitamin-rich food or, in areas with a known dietary deficiency, a supplement not to exceed 25,000 international units per week.

The need for a fair, efficient, and regular ration distribution cannot be overemphasized. Normally, rations are issued in 7- to 14-day intervals. Distribution intervals must be continually reviewed based on continuing assessment of the affected population. An accurate census is needed and a monitoring system must be established to ensure that the food is actually reaching every person as intended. Potential for some waste, diversion, and corruption always exists, but if these problems are severe they may lead to discontent and unnecessary suffering by the population.

a. *Types of Food Distribution*

Two types of food distribution are available: dry rations and cooked or “wet” rations. Whichever is used, those distributing the food must have exact instructions on the size of the rations. If scales are not available or become an inconvenient way to measure out food, cans or containers with a known weight/volume comparison for each commodity should be used. The distribution of food as prepackaged rations is an unsatisfactory solution and should be avoided if possible, but in some cases it maybe the only available option.

(1) Dry Ration Distribution (Take Home)

This method has major advantages over cooked food distribution. Dry ration distribution allows families to prepare their food as they wish, permits them to continue to eat together as a unit, and is generally more culturally and socially acceptable. This method also assumes that the family units have access to potable water.

Distribution is usually made at 7- to 14-day intervals. Where an accurate census is available and families have food distribution cards, some form of group distribution is possible. A designated family member or group leader

becomes responsible for receiving and distributing the food. This method is fast and relatively easy to monitor. In the initial stages, however, the best way to guarantee a fair distribution may be to have every individual present.

The food distributor is responsible to the people and camp authorities. A standard measure (e.g., a can) should be used for distribution. Each person should understand how much he or she should receive.

Groups should remain fixed to a piece of ground when they first register to prevent multiple registrations. Simultaneous food distributions will prevent people from moving from one distribution session to the next.

In addition to cooking pots, fuel, and utensils, displaced people must have containers and sacks (e.g., empty cooking oil tins and grain sacks) to protect and store their food rations. Depending on the type of food distributed, there may be a need for grinding and milling facilities.

Food distribution to dispersed populations may present problems. For example, if the displaced camp is located in a food-deficit area, the local population may become intermingled with the displaced population. The local government may try to prevent a census that might cause the local people to be excluded from the food distribution. One solution to overcome this problem is to have the traditional leaders of the displaced population do the distribution. Another solution is to have a separate food distribution system in the local community located away from the displaced settlement. This method should keep the local population out of the settlement. Although locating the local food distribution system away from the DP settlement will cause a certain diversion of commodities, this is sometimes an acceptable loss considering the alternatives. Food distributions may also interfere with original planning assumptions. If the affected population is in a village, it may have access to other food sources. Relief managers should take this into account and provide only a portion of their food requirements.

In providing food to dispersed populations, one must be very careful not to destroy local markets and marketing systems. Two methods for food distribution can be used: providing food directly or using the food-for-work or

cash-for-work methods. Village-based or nutrition-based distributions can also be used. The village-based method counts the number of people requiring food, determines the amount of food needed, and then gives that amount to everyone. This method is easy but expensive because no targeting is performed. These programs are difficult to end, and the local markets are disrupted by them. Nutrition-based food distribution programs target distribution to vulnerable groups and then decrease as the area's nutrition level improves. Although a good system, this method is complicated and staff intensive. It requires home visits, good records, nutrition-monitoring equipment, and trained people to administer the program. The quality and quantity of rations should be discussed regularly with the displaced people, and complaints should be investigated. Check that food is being properly distributed and used at the family level. Food basket monitoring, measuring the ration amount from a random selection of recipients just after they have received their ration, is a useful tool to ensure equitable and efficient distributions. Nutrition education can help with some problems and may prevent improper storage or spoilage, especially if the population is not accustomed to the type of food in their ration.

(2) Wet Ration Distribution

This method requires centralized kitchens with adequate utensils, water, fuel (although obviously less than the amounts required for family cooking), and trained, healthy personnel. At least two meals must be provided per day, and the efficient organization of wet ration distribution for large numbers is difficult. Such distribution may be necessary during the initial stages of an emergency, especially when families have insufficient cooking utensils or fuel.

7. Selective Feeding Programs

When malnutrition exists or the needs of vulnerable groups of infants, children, pregnant and lactating women, the sick, and the elderly cannot be met from the general ration, special arrangements are required to provide extra food. The vulnerability of these groups stems from the increased nutrient requirements associated with such factors as growth, production of breast

milk, repair of tissues, and production of antibodies. Selective feeding programs fall into three categories: SFPs, designed to meet the extra nutritional requirement of vulnerable groups; CTCs, which treat most severely malnourished people at home; and TFPs, lifesaving feeding programs designed to treat severe malnutrition.

Planning and implementation of SFPs, CTCs, and TFPs is a step-by-step process. Given the circumstances of each emergency, being flexible is important. Clear criteria and cutoff points for admission to SFPs, CTCs, and TFPs should be set up in agreement with all the local and humanitarian assistance organizations carrying out these programs.

a. *Supplementary Feeding Programs*

Small children are particularly susceptible to the cycle of infections and malnutrition. Sick children must eat and drink, even if they have no appetite, are vomiting, or have diarrhea. They must receive additional “supplementary” food whenever possible.

A SFP requires strong advocacy among the population. Its purpose must be clearly understood, otherwise some will question why the weak and sick are being fed when healthy children need food.

Consider the following factors when determining the need for an SFP:

- General rations average less than 1,500 kcal/person/day.
- 10 to 20 percent of the children are malnourished (children under 5 years old exhibit under 80 percent WFH or less than – 2 standard deviation Z-Score).
- Severe public health hazards exist.
- Significant diseases, especially measles, are prevalent or imminent.

The aim of an SFP is to provide high-energy, high-protein, low-bulk meals once or twice a day to those who need it. The number of meals depends on the nutritional status of the population, the nutritional value of the general ration, and the age of the beneficiaries. The size of the supplement also depends on the nutritional status of the beneficiaries. At least 400 kcal and 15 g protein per day, however, should be provided.

These programs usually take two forms: wet or dry rations. In addition to the criteria listed above for wet and dry general rations, supplemental dry rations should always be given priority in emergencies. Dry rations are easier to organize, less costly, lower the risk of communicable diseases, decrease the time mothers have to spend in centers, improve accessibility, and support local customs and household structures.

Wet rations should be considered if households face a lack of fuel or cooking facilities, if women are put at risk from carrying and storing a supplementary ration, or if a strong indication is apparent that children will not receive a ration in the household.

Supplementary meals should be prepared as porridge or soup, which are easily digestible and can be eaten by people of all ages. The food is generally based on cereal and legume blends with edible oil added to increase the energy content. Other ingredients (e.g., sugar, vegetables, fish, and milk) can be added to provide additional nutrients and a variety of flavors. Some prepackaged cereal/legume blended meals are available through UN agencies (e.g., corn-soya blend, wheat-soya blend) that may be useful at the start of an emergency feeding program if ingredients are familiar to the population. Local foods, however, should be substituted as quickly as possible and prepared in a more traditional and appropriate way. High-energy, high-protein biscuits are also sometimes early in the program. These biscuits are specially blended to be a high-protein and high-energy food supplement in a dry, easy-to-distribute form. Their use, however, is not encouraged for supplementary feeding because they serve a special niche, where cooking facilities are unavailable for an emergency feeding program or for distribution as a supplementary food source for a displaced population on the move.

Supplementary feeding programs are usually implemented either as targeted or blanket programs, depending on the objectives and available resources for the program.

(1) Blanket SFPs

Blanket SFP distributions are implemented to reduce or prevent the deterioration of a precarious nutritional situation. Blanket SFPs are those in which all vulnerable groups

receive a supplementary ration (usually a dry ration of a blended food). In addition to pregnant and lactating women and sick and elderly persons, blanket SFP programs usually include all children under 5 years of age and do not use anthropometric measurements (weight and height) to define vulnerability.

(2) Targeted SFPs

If food resources are limited, then a more restricted (targeted) program is most likely to be appropriate. Targeted SFPs establish anthropometric criteria for those “targeted” to receive a supplementary ration. Targeted SFPs must be based on the active identification of, and follow up on, those considered vulnerable. This requires a regular house-by-house or family-by-family assessment, usually made by public health workers operating through a referral system. In addition to encouraging those in need to participate in the SFP and ascertaining the reasons for nonparticipation, continued home visiting is required to monitor the progress of infants and children. Those identified for the program should be registered and issued a numbered identity bracelet or card to facilitate followup. An SFP that does not actively identify those in need, but operates on an open “come-if-you-wish” basis, is unlikely to benefit those in greatest need and often results in poor use of food and organizational resources.

Families of children enrolled in the SFP should be provided a general food ration. This action will decrease the sharing of supplementary food that usually happens in families and will expedite the rehabilitation of the malnourished child.

The criteria for admission to a targeted SFP will depend on the condition of displaced people and resources available. The order of priority for is as follows:

1. Any malnourished child (less than 80 percent WFH or a Z-Score of less than - 2).
2. Women during the last 3 months of pregnancy and the first 12 months of lactation.
3. Medical referrals and the socially vulnerable, such as the elderly.

Children should not be discharged from the SFP until they have maintained more than 85 percent WFH for at least 1 month. They should be discharged into a general food distribution system for at least 3 months to solidify nutritional gains made while in the SFP.

b. Exit Criteria

Once begun, SFPs must be considered necessary until an appropriate general ration is provided that meets the needs of the vulnerable population. SFPs should be phased out if surveillance results reflect sustained improvement and global malnutrition prevalence is less than 10 percent among children less than 5 years of age, the mortality rate is low, and seasonal deterioration of the nutritional status is not anticipated (e.g., a rainy season). As children improve, they should be graduated from the program. Otherwise, the SFP becomes too large and unmanageable.

c. Supplementary Food Quantities

The typical daily supplementary ration is illustrated below along with the amount of food required (approximately 3.6 metric tons) for supplementary feeding of 1,000 beneficiaries over a 1-month period.

Table III-10. Typical Daily Ration With Monthly Totals (in metric tons)

Commodity (Daily)	Amount (g)	Energy (kcal)*	Fat (g)	Protein (g)*	Metric tons (Monthly)
Cereal (rice)	50	180	0	4	1.50
Vegetable oil	10	89	10	0	0.30
WSB**	55	204	3	11	1.65
Salt	5	0	0	0	0.15
Total	120	473	13	15	3.60

*Meets minimum levels of 350 kcal of energy and 15 g of protein/person/day.

**Wheat-soya blend.

d. Organization and Management of an SFP

Any SFP must be closely integrated with a community health care program, because the SFP will identify and refer health problems. Certain daily medications (e.g., iron, folate) may best be given in the course of the supplementary feeding.

Feeding centers and kitchens must be well organized and kept clean. Long waiting periods must be avoided and the schedule must not clash with family mealtimes or other essential community activities. Mothers may have to be fed with children to ensure that vulnerable children receive special feeding. Parents must understand that the SFP is given in addition to, not in lieu of, the normal meal. Otherwise, parents will think that young children are fed at the center while older children must eat at home. Utensils, bowls, scales, fuel, water, storage facilities, and other equipment will be required. These materials can generally be obtained locally. Some of these supplies are available with an Oxfam Feeding Kit.

One SFP center can usually handle up to 500 beneficiaries. The centers should be run by DPs who have received training. An experienced nurse should be able to supervise four to five centers. If different organizations establish separate SFP centers, central coordination and standardized procedures for all centers are very important. Programs must not be overly dependent on outside assistance to help ensure that they are sustainable when individuals or organizations leave.

8. Community Therapeutic Care Programs

CTC is a community-based approach of care for managing large numbers of acutely malnourished people. The CTC approach treats the majority of the severely malnourished at home and uses outreach teams to promote community participation and behavioral change. CTC aims to build community capacity to manage and better respond to repeated cycles of relief and recovery. Providing appropriate therapeutic foods containing the right mix of nutrients is central to the home-based care of the severely malnourished. Ready-to-use therapeutic foods (RUTF) have been specially designed for the treatment of severe acute malnutrition. RUTF can also be manufactured locally, thereby increasing availability and reducing costs.

9. Therapeutic Feeding Programs

Therapeutic feeding reduces deaths among infants and young children with severe PEM. The main causes of death in severe PEM are dehydration, infection, hypothermia, hypoglycemia, cardiac arrest, and severe anemia. If severe PEM exists, therapeutic feeding will be one of the best ways to save lives. If the startup of an SFP is delayed (e.g., if resources, particularly

trained personnel, are concentrated on a TFP), however, there may be a sudden deterioration in other less-malnourished children, with life-threatening consequences. Having a TFP that saves the lives of a few is less important than an adequately functioning SFP benefiting a larger population.

Food is the treatment for PEM. Unlike SFPs, TFPs are used solely for curative measures and should be administered only as short-term programs. The need for its continuation will depend on the effectiveness of general and supplementary feeding programs as well as the nutritional condition of new arrivals to TFP programs.

The usual criteria for admission to a TFP are if a child under the age of 5 years suffers from bilateral edema on the feet (kwashi-orkor) or severe marasmus (WFH less than 70 percent or a Z-Score of less than - 3). If persons older than 5 years are to be admitted, their nutritional status should be assessed clinically because clear anthropometric criteria do not exist. Patients should remain on a TFP until they are free from illness, at least 80 percent of WFH, and without edema. On graduation from a TFP, patients should be discharged to an SFP.

Therapeutic feeding should take place on an inpatient basis whenever possible, as food must be given every 3 to 4 hours. Three products are available as "ready to use" sachets for the treatment of severe malnutrition: (1) a special oral rehydration solution for use for the malnourished, (2) a formula for the severely malnourished during the first few days (phase 1) of treatment called F75, and (3) a formula for rapid growth (phase 2) called F100. They are produced by companies such as Nutriset in France and Compact in Denmark. These products include not only the appropriate protein and caloric mix for safely feeding the severely malnourished, but also the essential vitamins and minerals that are often missing in feeding mixtures that use skim milk.

Infection and dehydration are the major causes of death. Patients must be closely watched for medical complications. If weight does not increase quickly at a properly run TFP, the individual is likely to also have an illness that must be treated. The immunization of children against measles is a priority because of the high mortality associated with this disease in a malnourished population. All children admitted to a TFP should be given a full course of vitamin A, with doses on days 1, 2, and 7 of admission.

TFPs must be run by experienced and qualified personnel. One center can usually handle about 50 children and will require two experienced supervisors working full time. Doctors and nurses with little training in nutrition or experience in treating severe PEM must be given necessary guidance. Displaced people and mothers of patients, in particular, should be involved in running the therapeutic feeding center.

10. Infant Feeding and Milk Products

Human milk is the best and safest food for infants and children under 2 years of age. Breast-feeding also provides a secure and hygienic source of food, as well as antibodies that protect against some infectious diseases. Therefore, promoting lactation, even among sick and malnourished mothers, is important. In some cases, mothers may need to receive extra food to encourage breast-feeding and provide the additional calories and nutrients required. This should be done through the SFP.

Problems associated with using infant formula and feeding bottles are exacerbated in a displaced population situation. Clean, treated water is essential but rarely available to dilute the formula. If local groundwater sources may contain elevated nitrate levels, water should not be treated by boiling, which increases the concentration of nitrates. Careful dilution of the formulas is also difficult to control as mothers are unlikely to be familiar with the use of infant formula and instructions are often in a foreign language. If unavoidable, infant formula should be distributed from health or feeding centers under strictly controlled conditions and proper supervision. Infant feeding bottles must never be distributed or used; they are almost impossible to sterilize and to keep sterile under such conditions. Babies should be fed by a clean cup and spoon if necessary.

Milk should not be distributed if it is not a traditional part of the DP's diet. Some populations may even have lactose (milk sugar) intolerance.

The use of dried milk powder also has major practical problems. Both hygiene and proper dilution are difficult to ensure. Also, powdered milk mixed with unsafe water or exposed to dust or flies can easily become contaminated and provide an ideal environment for bacterial growth. For these reasons milk should not form part of the general ration, unless milk was used as a normal source of protein for the displaced population.

In addition to infant formula, products commonly offered in emergencies include dried whole milk, dried skim milk (DSM), sweetened and unsweetened condensed milk, and evaporated milk. Their appropriateness must be ascertained before acceptance. It should be noted that if the DSM is vitamin A fortified, the vitamin A has a shelf life of 6 months.

Milk products are useful in SFPs and TFPs when administered under supervision and controlled and hygienic conditions. For example, milk can be added to SFP cereal mixtures to boost their protein content. Milk powder is the usual basis for early stages of treatment in therapeutic feeding.

11. Food Commodities

a. Nutritional Value of Food Commodities

Table III-11 lists the approximate nutritional values of various commodities. Note, however, that several of the commodities listed on the table are not available through Public Law (P.L.) 480 (the Agricultural Trade Development and Assistance Act) Title II (Emergency and Private Assistance). If more information is desired on these commodities, contact the Office of Food for Peace (FFP).

**Table III-11. Approximate Nutritional Value of Commodities
(per 100 g edible portion)**

Commodity	Energy (kcal)	Protein (g)	Fat (g)
Cereals			
Wheat	330	12.3	1.5
Wheat flour	350	11.5	1.5
Bulgur wheat	350	11.0	1.5
Maize	350	10.0	4.0
Maize meal	360	9.0	3.5
Sorghum	335	11.0	3.0
Rice	360	7.0	0.5
Rolled oats	380	13.0	7.0
Blended Foods			
Instant corn-soya blend	365	12.2	4.0
Corn-soya blend	380	18.0	6.0
Wheat-soya blend	370	20.0	6.0
Soya-fortified bulgur wheat	350	17.0	1.5
Soya-fortified corn meal	360	13.0	1.5
Soya-fortified rolled oats	375	21.0	6.0
Soya-fortified wheat flour	360	16.0	1.3
Pulses			
Dried peas and beans	335	22.0	1.5
Ground nuts	330	15.0	25.0
Milk, Cheese, and Eggs			
Dried skim milk	360	36.0	1.0
Dried whole milk	500	26.0	27.0
Cheese	355	22.5	28.0
Dried eggs	575	45.5	43.5

**Table III-11. Approximate Nutritional Value of Commodities
(per 100 g edible portion) (continued)**

Commodity	Energy (kcal)	Protein (g)	Fat (g)
Meat and Fish			
Canned meat	220	21.0	15.0
Dried salted fish	270	47.0	7.5
Canned fish in oil	305	22.0	24.0
Fish protein concentrate	390	75.0	10.0
Oils and Fats			
Vegetable oil	885	0	100.0
Butter oil	860	0	98.0
Margarine	735	0	82.0
Edible fat	900	0	100.0
Fruits and Beverages			
Dried fruit	270	4.0	0.5
Dates	245	2.0	0.5
Jam	265	0	0
Tea	0	0	0
Coffee	0	0	0
Miscellaneous			
Sugar	400	0	0
Iodized salt	0	0	0
Pasta	365	12.5	1.2
Freeze-dried meat	480	65.0	25.0
Minestrone	500	22.5	27.0
Protein-enriched ration	450	16.7	15.5
Milk biscuits (whole milk)	470	23.4	10.4
Milk biscuits (skim milk)	375	24.0	1.5
High-energy protein biscuit	450	15.0	20.0

b. Food Aid Storage Requirements

If food aid is provided, it often must be stored at a warehouse and distributed as needed. This section is designed to help determine how much space is required for a given amount of food aid. The information needed is:

- Size of daily ration.
- Number of people to be fed.
- Number of days of stock needed.
- Volume of commodity.
- Storage configuration at warehouse.

To illustrate, the amount of grain needed to provide a 60-day supply of a 400-g grain ration to feed a population of 1,000 people:

$$400 \text{ g/day} \times 1,000 \text{ people} = 0.4 \text{ t (metric tons)}$$

$$0.4 \text{ t per day} \times 60 \text{ days} = \mathbf{24 \text{ t}}$$

To determine the floor area needed, the volume of the commodity and the storage configuration at the warehouse are required. The volume of 1 t of grain is 1.5m³. If the grain will be stacked in 4-m high piles, the required floor area is:

$$1.5 \text{ m}^3 \text{ per t} \times 24 \text{ t} = 36 \text{ m}^3$$

$$36 \text{ m}^3 / 4 \text{ m} = \mathbf{9 \text{ m}^2}$$

The floor space must be increased by 20 percent to allow for access aisles and ventilation within the warehouse.

Therefore, the total warehouse space needed is:

$$9 \text{ m}^2 \times 1.2 = \mathbf{10.8 \text{ m}^2}$$

The FFP or OFDA Logistics can also help in determining storage needs.

E. Health

1. Introduction

When an emergency or crisis occurs, the public health system is often disrupted or destroyed. If the emergency is in a resource-poor area, the local public health system may have been ineffective or even nonexistent before the event. During the emergency response, where the aim is to prevent deaths related to the disaster, the first priority is the provision of basic

medical care while re-establishing public health services (safe water and sanitation, disease surveillance and response, immunizations, etc.). If the situation is an earthquake or conflict emergency, a significant need for trauma care may exist. Positions on the DART can be filled as needed to deal with trauma care situations.

The level of health care provided will be determined by the condition of the affected population and the available resources. This level will be partially guided by the diseases endemic to the area and those that cause the greatest morbidity and mortality. Many of these diseases are discussed later in this section with guidance provided for their prevention and treatment. In theory, the emphasis of the health services should be on prevention, as the staff and other resources needed for treatment may not be adequate. Once morbidity rates are stabilized, the level of health care provided can be more comprehensive. Health care, however, should be appropriate for the local population and at a level that can be maintained. Services and levels of care should strive to adhere to international guidelines such as the Sphere standards. Guidance for the provision of health services and staffing is found later in this section.

2. Background Information for Initial Health Assessments

People with field experience and an understanding of epidemiology usually conduct the initial assessment (also called a rapid health assessment) as part of a multidisciplinary team. The purpose of the following section is to provide OFDA Assessment Team or DART members a basic understanding of some common epidemiological terms and how to calculate rates for the presence of diseases commonly found when doing rapid health assessments. This section also includes definitions for the two epidemiological concepts that form the core of science-based disaster response: **mortality rate** and **morbidity rate**. The intent is not to teach team members how to conduct epidemiological surveys, but rather to help them understand and evaluate data from surveys they may encounter in the field.

a. Epidemiologic Concepts

Epidemiology is the study of the occurrence, distribution, and determinants of diseases and injuries in human populations. An epidemiologist is concerned with the types and frequencies of illnesses, injuries, and other health-related

conditions within a given population, and the factors that influence their distribution. The overall goal of the epidemiologist's work is to discover the factors essential for diseases to occur within groups and then to find the best methods to reduce or prevent those factors and other conditions detrimental to the health of communities.

b. Epidemiologic Definitions

Endemic. The constant presence and/or usual presence of a disease or condition found in a population within a geographic area. This may also be thought of as the baseline.

Epidemic. The increase of cases of a disease, often occurring suddenly, than what would be expected for that population in that area or at that time. Even one or two cases of certain diseases (such as cholera) can be considered an epidemic. In other circumstances, an epidemic is defined by *where* the cases occur (e.g., West Nile virus in the United States) or *when* the cases occur (e.g., influenza in the summer).

Outbreak. Has the same definition as epidemic but is often used for a more limited geographic area.

SOME WORDS OF CAUTION:

Both terms, *epidemic* and *outbreak*, are often used interchangeably by epidemiologists. Some, however, consider outbreak to refer to a more localized situation, while epidemic is used to describe a more widespread and perhaps more prolonged occurrence. Because the word epidemic can be provocative, try to avoid using it when in the field, and use outbreak instead (refer to the "Prevention and Control of Infectious Diseases" section for the outbreak thresholds for specific disease).

Latency Period. The time between first contact with a noninfectious agent (cold, heat, radiation, poisons, toxins, etc.) and when symptoms appear. If the agent is infectious (bacteria, virus, parasite, etc.) the latency period is called the **incubation period**. Epidemiologists often calculate the average incubation period for a group and then look back in time to see when exposure to the agent could have occurred.

Incidence. A measure of the frequency with which an event, such as a new case of illness, occurs in a population over a period of time. New cases of a disease can occur either through

onset of the disease in current members of the population or by immigration into the population of persons already ill. The formula for determining incidence rates is:

$$\text{Incidence Rate} = \frac{\text{Number of new cases of a disease during a specified period of time}}{\text{Number of persons at risk of developing the disease during that period}} \times 10^n$$

Prevalence. The proportion of a population with an illness or condition (both new and pre-existing cases). This may be a point in time (a point prevalence) or a period of time (a period prevalence). The formula for prevalence is:

$$\text{Prevalence} = \frac{\text{Total number of cases of a disease (old and new)}}{\text{Number of persons at risk of developing the disease}} \times 10^n$$

The major distinction between prevalence and incidence is that *incidence is the frequency of the appearance of disease* and *prevalence is the percentage of the population with the disease*. Remember that both incidence and prevalence may be expressed as per 100 (10^2), 1,000 (10^3), or 10,000 (10^4). The value of n in the above equations depends on the relative frequency of a given disease. Also note that incidence is always expressed as a rate (meaning that it includes the concept of time), whereas prevalence may be expressed as a rate or as a simple proportion. For prevalence and incidence measurements to be useful, they must use the precise definition, and the time periods must be clearly designated.

c. **Mortality and Morbidity Rates**

Mortality rates and morbidity rates are two specific types of epidemiologic measures. They are discussed separately because of their importance and distinction in the disaster setting.

(1) Mortality Rate

The **mortality rate** (death rate) is the single most important indicator of serious stress (e.g., illness, malnutrition) in an affected population.

The **crude mortality rate (CMR)** is number of deaths in a population per 10,000 persons per day.

In well-run relief efforts, the overall CMR should not exceed **twice** that of the host population before the emergency. When that information is unknown, health agencies should aim for a CMR of below 1.0/10,000/day. A CMR exceeding 2.0/10,000/day indicates a serious situation requiring immediate action. In general, even initially high mortality rates should fall to below 1.0/10,000/day within 4 to 6 weeks of beginning a basic support program that provides sufficient food and water, immunizations, simple health care, and other immediate needs, assuming that insecurity is not a concern. For children under 5 years of age, the average mortality rate is approximately 1.03/10,000/day in most developing countries during nonemergency times. The rates in Sub-Saharan African countries are somewhat higher at 1.14/10,000/day. When the baseline of the children under 5 mortality rate (U5MR) is unknown, health agencies should aim for a U5MR below 2.0/10,000/day. A higher rate should be thoroughly investigated and addressed, and a rate twice the norm should be considered an emergency situation. Remember that in an emergency the critical task is to decrease the mortality rate, as it reflects a range of stress on the population. It will also be a measure by which the relief effort will be judged.

The following is the procedure for calculating mortality rates.

Crude Mortality Rate =

$$\frac{\text{Total number of deaths in a given time period}}{\text{Estimated total population x Number of days in the time period}} \times 10,000$$

Example: 52 deaths in 2 weeks in an affected population of 40,000 people

$$\frac{52 \text{ deaths} \times 10,000}{40,000 \text{ people} \times 14 \text{ days}} = 0.93 \text{ deaths}/10,000/\text{day}$$

Under-5 Mortality Rate: The number of under-5 deaths per 10,000 under-5 children per day.

$$\text{Under-5 Mortality Rate} = \frac{\text{Total number of deaths in children} < 5 \text{ y.o. in a given time period}}{\text{Estimated population} < 5 \text{ y.o.} \times \text{Number of days in the time period}} \times 10,000$$

Example: 40 deaths in under-5 kids in 1 week in a population with 25,000 children under 5 years in age

$$\frac{40 \text{ deaths} \times 10,000}{25,000 \text{ people} \times 7 \text{ days}} = 2.3 \text{ deaths}/10,000/\text{day}$$

(2) Morbidity Rate

While mortality rates measure deaths, **morbidity rates** measure the frequency of illness within specific populations. Unlike mortality rates, which are always an incidence, morbidity may be reported as an incidence or prevalence (see the previous section of definitions). Incidence is the preferred count for diseases of short duration, such as measles, mumps, and rubella. Prevalence is useful for chronic diseases of longer duration such as malnutrition. Time and place must always be specified.

3. Prevention and Control of Infectious Diseases

a. Introduction

In an emergency, priority should be given to prevention and control of infectious diseases. The risk of infectious disease transmission increases with overcrowding, poor environmental conditions, poor sanitation, water of inadequate quantity and quality, and poor overall state of health of the affected population. Infectious diseases can dramatically increase morbidity and mortality in emergency situations, particularly in situations involving DPs. More than 80 percent of all deaths in displaced populations are caused by five major conditions: malnutrition, measles, acute respiratory infections (ARIs), diarrheal diseases including cholera and shigella dysentery, and malaria. Other diseases of significance in emergencies include typhoid, hepatitis A, sexually transmitted infections including HIV/AIDS, tuberculosis, diphtheria,

meningococcal meningitis, influenza, anthrax, SARS, polio, guinea worm, filariasis, schistosomiasis, scabies, and emerging infections of unknown etiology. Attention should be paid to patterns of antimicrobial resistance in common pathogens. While malnutrition and vitamin deficiencies are not infections, they increase the vulnerability of the population to a variety of infections. Diabetes, HIV/AIDS infection, trauma, and intravenous drug use also increase vulnerability and susceptibility to various infectious diseases.

Improving the public health of the affected population is the cornerstone of disease prevention efforts. In a DP camp situation, special attention should be paid to the location and the plan for the site to minimize crowding and facilitate the development of appropriate water supply and sanitation facilities. Environmental health factors must be considered, such as ensuring adequate safe water and soap, proper disposal of excrement and garbage, the control of rodents and disease-carrying vectors (mosquitoes, flies, ticks, etc.), and education of the population on general public health issues.

One of the first actions in an emergency is to ensure that a surveillance system is in place that can detect serious infectious diseases. Some of these diseases may be monitored on the basis of presenting symptoms; many infectious diseases, however, will require the collection of specimens and expert laboratory confirmation in internationally approved laboratories. It will often be important to detect or confirm patterns of antimicrobial susceptibility and resistance in disease organisms. The rates and trends of diarrhea, bloody diarrhea, rash and fever illness, fever, acute respiratory illnesses, maternal post-partum fever, malnutrition in adults and children, malnutrition with edema, neonatal mortality, infant mortality, and crude mortality should be tracked to evaluate relief efforts.

Measles immunizations for young children are a priority during the early weeks of an emergency even when resources are scarce. Routine immunizations (e.g., diphtheria-tetanus-pertussis [DTP], polio, and tuberculosis [BCG]) can be given later, once health facilities have the capability to institute vaccination programs. It must be remembered that vaccines *prevent* diseases, but they do not *cure* them. Therefore, vaccine-preventable diseases must be anticipated and preventative measures such as vaccine campaigns must be implemented early.

During emergencies, rumors of epidemics often run wild. These rumors should be quickly confirmed or refuted by responsible experts, and all relevant information disseminated to the affected population.

b. Common Diseases in Emergencies

This section provides information on diseases that are common in emergency situations. It includes information on the symptoms, transmission, and possible curative and/or preventive measures. Outbreak thresholds have also been included for diseases that have a clearly defined threshold.

Nutritional diseases are addressed in the Nutrition section of this chapter.

(1) Acute Respiratory Infections

Identification. ARIs include both upper respiratory infections (e.g., cold and pharyngitis) and lower respiratory infections (bronchitis, bronchiolitis, and pneumonia) and are marked by cough, fever, otitis media (inflammation of the middle ear), and shortness of breath. ARIs may be mild or may progress rapidly to death, especially among malnourished children. Pneumonia is responsible for the majority of ARI deaths and should be recognized and treated presumptively with antibiotics. Children who die from pneumonia are generally young in age and often die within a short time after becoming ill.

Infectious agents. Multiple bacteria and viruses.

Occurrence. Worldwide.

Mode of transmission. Airborne or droplets (caused by coughing), contact with nasal or throat secretions or with objects soiled with secretions from the nose and throat.

Incubation period. Varies, depending on the pathogen, but generally 1 to 10 days.

Communicability period. Varies, depending on the pathogen. Hand washing and/or covering the mouth with cloth or tissues reduces transmission.

Susceptibility and resistance. Infants and elderly at the highest risk, individuals with serious (HIV/AIDS) and/or chronic (TB) illnesses and malnutrition.

Methods of control.

- 1. Preventive measures.** (1) Educate patients to wash hands, cover mouth and nose when coughing and sneezing, and place articles soiled with nasal and oral discharges in garbage bins; (2) increase separation between patients to more than 1 m; (3) increase ventilation in buildings and tents and avoid exposure with smoke from cooking fires; and (4) provide adequate, shelter, clothing, and blankets.
 - 2. Case Treatment.** Provide cross ventilation in patient care areas, and feeding centers. Conduct an active case-finding campaign in homes to identify pneumonia. Cotrimoxazole is recommended for cases of pneumonia diagnosed by the Integrated Management of Childhood Infections guidelines.
 - 3. Epidemic measures.** Epidemic pneumonias should be assessed by laboratory methods to identify the etiologic agent and antimicrobial susceptibility.
- (2) Diarrheal Diseases

Identification. Diarrhea is commonly defined as three or more loose or fluid stools in a 24-hour period. Diarrheal diseases are a major killer of children worldwide, primarily due to poor water quality and inadequate water quantity and sanitation facilities. Complications among young children can result in dehydration and shock. Without rehydration and continued feeding, diarrhea in malnourished children is often fatal.

Infectious agent. Diarrhea is a symptom caused by many different pathogens and pathologies. Common diarrheal conditions include acute bloody diarrhea requiring antibiotic treatment and rehydration if necessary (shigella dysentery); acute watery diarrhea requiring intensive rehydration and antibiotic treatment to shorten the course of the illness and the associated discharge of infectious organisms (cholera); and diarrheas caused by a variety of other pathogens, including various pathogenic and toxogenic strains of *E. coli*, salmonella, and typhoid. Often rehydration alone will suffice to treat diarrhea, although appropriate antimicrobial therapy may be essential in treating certain organisms. Profuse diarrhea that is watery and pale in color (i.e., rice-water diarrhea)

is often a result of cholera, whereas bloody diarrhea with relatively small volume is often the result of shigella dysentery. Cholera and shigella are discussed separately, as they can be particular problems in disaster settings.

Disaster implications. Diarrheal diseases are prevalent in disaster situations due to inadequate sanitation and water supply, as well as overcrowding and lack of knowledge regarding proper hygiene practices such as hand washing.

Methods of control.

- 1. Preventive measures.** Provide as much clean water as possible at easily accessible points close to living quarters and institute sanitation services. Promote the importance of hand washing and disposal of excreta; promote exclusive breast-feeding. Very young children are extremely susceptible to diarrheal diseases because of their generally poor hygiene practices and their lack of acquired immunity to various pathogens. Mortality among very young children due to diarrheal diseases is a serious concern because they can quickly become severely dehydrated.
- 2. Case Treatment.** Many diarrheal diseases are mild and self-limiting even without treatment. The greatest risk is from dehydration. If fluids and electrolytes can be replaced by drinking and eating or oral rehydration salts (ORS), most diarrhea patients will recover in a relatively short time. Both rehydration and treatment are needed for bloody diarrhea caused by shigella, amebic dysentery, *E. coli*: 0157, and typhoid.

The following measures should be taken for most diarrheal diseases:

- Confirm the severity of the problem by reviewing morbidity and mortality data. Additional information, such as the location of patients in the camp, the length of time in the camp, and the sources of family water and food, can help pinpoint the source of infection.
- Emphasize sanitation and hand washing. Perform surveys of water supply facilities to identify potential sources of contamination. Disinfect water supplies as appropriate and check treated

water for chlorine residual. Perform standard test for the presence of fecal coliform bacteria to determine if fecal contamination of water supplies has occurred.

- Stress the importance of oral rehydration therapy (ORT). Commercially available packets containing the proper mixture of electrolytes (use World Health Organization [WHO] recommendations for the home therapy) are strongly preferred because local preparation with excessive potassium chloride can lead to serious complications and may be fatal. Oral rehydration is the treatment of choice. In situations where a patient cannot drink or has severe dehydration, however, rehydrating him or her appropriately and as quickly as possible with intravenous fluids (IVs) is critical.

Other diseases to consider. Cholera and shigella dysentery are discussed more specifically below.

(3) Cholera

Identification. Cholera is characterized by sudden onset of profuse, painless, watery stools with vomiting and nausea early in the course of the illness. While only 1 percent of exposed persons may develop symptoms, severe diarrhea may lead to rapid dehydration and even death. The recommended treatment is oral rehydration. IV therapy is used for severe dehydration when oral rehydration is not possible.

Occurrence. Endemic in many countries; cases tend to increase in the rainy seasons.

Mode of transmission. Transmission occurs primarily through ingestion of water/food contaminated with feces containing cholera bacteria. Person-to-person spread generally does not occur, as a very large dose of the organism (as high as 100,000 to 1 million organisms) is required to transmit the disease. Faulty municipal water systems, contaminated surface water, and improper storage of domestic water storage have resulted in large outbreaks.

Incubation period. The incubation period for cholera is usually 2 to 3 days, but can be from a few hours to as long as 5 days.

Communicability period. Patients generally carry the cholera bacteria in their stools only while they are having diarrhea and for a few days after recovery. Occasionally, the carrier state may persist for a few months.

Susceptibility and resistance. Variable; breast-fed infants are protected.

Outbreak threshold. One case confirmed by laboratory. Case fatality rates should be kept at 1 percent or lower.

Methods of control.

- 1. Preventive measures.** WHO does not recommend cholera immunization with currently available antigens (see the sections of this chapter on water and sanitation for recommendations on water supply and safe disposal of excreta). Water should be treated (preferably filtered and chlorinated), particularly water used for infant food preparation. Encourage frequent hand washing and cleaning of feces from contaminated surfaces with 1:100 bleach solution (made from 5-percent sodium hypochlorite solution) is encouraged. Encourage mothers of infants below 6 months of age to breast-feed exclusively.
- 2. Case treatment.** Prompt, appropriate rehydration is essential. See section above on diarrhea.
- 3. Epidemic measures.** If cholera is suspected, the following measures should be taken:
 - Report suspected cases to national public health authorities and WHO.
 - Confirm the diagnosis by culturing stool samples from a few suspected cases. Regional public health laboratories or a hospital lab in the capital city should be able to help confirm this diagnosis by testing the samples. Once laboratory confirmation occurs and cases of cholera are established to be prevalent within the population, all cases presenting with cholera symptoms need not be laboratory confirmed.
 - Check water and sanitation measures to ensure that water is safe and protected from sewage contamination (the source of the infection in most cases).

(4) Shigellosis (Bacillary Dysentery)

Identification. Shigellosis is an acute bacterial disease characterized by bloody diarrhea accompanied by fever, nausea, sometimes vomiting, and cramps. In typical cases, the stools contain blood, mucus, and pus and will need to be distinguished from amebic dysentery. About a third of the cases present with a watery diarrhea. Convulsions may occur in young children. Mild and asymptomatic infections occur. Illness can last several days to weeks, with an average of 4 to 7 days.

Infectious agent. Diagnosis is made by isolation of shigella from feces or rectal swabs. Infection is usually associated with the presence of pus cells in the stool.

Occurrence. Worldwide, two-thirds of shigellosis cases, and most of the deaths, are in children under 10 years of age. Illness in infants under 6 months is unusual. Outbreaks commonly occur under conditions of crowding and where personal hygiene is poor. Shigellosis is endemic in both tropical and temperate climates.

Mode of transmission. Transmission is almost always by direct or indirect fecal-oral transmission from a patient. Infection may occur after the ingestion of only 10 to 100 organisms. Water transmission may occur as the result of direct contamination. Potential exists for flies to transfer organisms to food, in which they can multiply to an infectious dose.

Incubation period. 12 hours to 1 week.

Communicability period. During acute infection and until the infectious agent is no longer present in feces, usually within 4 weeks after illness. Asymptomatic carriers may transmit infections. Appropriate treatment usually reduces the duration of the illness to less than 1 week.

Susceptibility and resistance. The severity of morbidity and mortality rate are functions of the age and state of health of the victims.

Disaster implications. Shigella is a common cause of dysentery outbreaks.

Outbreak threshold. One laboratory-confirmed case. Case fatality rates should be kept at 1 percent or lower.

Methods of control.

- 1. Preventive measures.** Provide large volumes of soap and water to permit hand washing and bathing after toileting, caring for ill family members, and before cooking and eating. Provide toilet facilities which are separated from bathing areas and drinking water sources.
- 2. Case treatment.** See section above on diarrhea. Appropriate antibiotic therapy is essential.

(5) HIV/AIDS

Identification. AIDS (acquired immunodeficiency syndrome) is the late state of a severe disease syndrome caused by HIV (human immunodeficiency virus) that affects the immune system. From 2 weeks to 2 months after infection, the initial symptoms of fever, sore throat, and cough appear, lasting 1 or 2 weeks. The next clinical manifestations (opportunistic infections or cancer) may not appear for several months or years. The timing seems to depend on the severity of immune system dysfunction.

Occurrence. Worldwide, with the disproportionate burden in Africa.

Mode of transmission. Transmission occurs through: (a) sexual intercourse; (b) reuse of needles; (c) transfusion of or exposure to infected blood; and (d) mother-to-child transmission during pregnancy, labor and delivery, or through breast-feeding.

Incubation period. Variable; the time from infection and detectable antibodies is usually 1 to 3 months.

Communicability period. Lifelong.

Susceptibility and resistance. Nearly universal; women are at increased risk of sexual transmission.

Methods of control.

- 1. Preventive measures.** Sexually transmitted disease treatment programs, as presence of sexually transmitted infections increases the risk of transmission. Condom use has been shown to reduce the risk of transmission. Programs that reduce the economic vulnerability of young girls to older men reduce rates

of infection. Distribution of relief commodities to women head-of-households reduces their economic dependence on men and reduces the need to exchange sex for survival commodities.

- 2. Case treatment.** Post-exposure use of condoms decreases the risk of transmission. Provide treatment for opportunistic infections (e.g., cotrimoxazole and/or TB preventive therapy) that may hasten death. Typhoid is a common opportunistic infection in disaster settings.
- 3. Epidemic and disaster measures.** Protective measures for women and children that reduce risk of rape and the need to exchange sex for survival commodities. Procure adequate number of single-use syringes. Used syringes should be destroyed to reduce injury or reuse. Blood donors should be tested, before donation, with rapid HIV/AIDS tests. Condoms should be procured and distributed. Sexually transmitted infections should be treated using syndromic protocols if rapid diagnostic tests are unavailable.

(6) Measles

Identification. Measles is a highly contagious viral infection characterized initially by cough, running nose, and red eyes (conjunctivitis). These symptoms are followed in 3 to 7 days by a high fever, which precedes a dusty red, raised blotchy rash that begins on the face (and may extend over the rest of the body) and lasts 4 to 6 days. Measles spreads very rapidly throughout a population and can result in case fatality rates of more than 10 percent in the presence of common complications such as malnutrition, diarrhea, and pneumonia. Measles also exacerbates vitamin A deficiency, which can lead to blindness.

Mode of transmission. Principally airborne. Measles can be transmitted to persons entering a room after the patient has left.

Incubation period. About 10 days.

Communicability period. Usually about 4 days before the appearance of the rash until 4 days after the appearance of a rash.

Susceptibility and resistance. More common in the malnourished, especially in vitamin A deficiencies. Immunity after an illness is permanent.

Disaster implications. Children admitted to feeding programs should be immediately vaccinated against measles if they have not been vaccinated or if their status is uncertain. During outbreaks, home visitors and community health workers should conduct active case finding using a standard case definition for measles. All suspected cases should be referred promptly to a health facility. These children should have their nutritional status monitored regularly to make sure that they are eating their rations or breast feeding.

Methods of control.

- 1. Prevention measures.** A coverage rate of measles vaccine below 80 percent in a displaced population should be regarded as an emergency. Measles vaccines should ideally be given as soon as the at-risk population can be accessed, since action after the disease is detected in high-density populations may be too late. If significant malnutrition is present in the under-5 population, implementing a measles vaccination program as soon as possible is absolutely essential.

Plans should be made in coordination with the national or regional measles strategy, and in collaboration with the WHO Expanded Program for Immunization (EPI) recommended strategy regarding strain of vaccine, use of vaccine meeting WHO quality standard, use of auto-destruct syringes, single-use mixing syringes, target age range, goal to control disease or interrupt transmission, opportunity for a second dose, and monitoring of adverse events. Complete information is available at the WHO Web site, <http://www.who.org>. Relief objectives and local epidemiology will guide whether children are immunized from 6, 9, or 12 months of age. No harm will occur if children receive more than one dose. If vaccine supplies are too limited for public health purposes, malnourished, HIV positive, and hospitalized children should be vaccinated first. The vaccine should not be given to girls who may be pregnant, or those children with severe egg allergies. The vaccine does not contain preservatives and

must be discarded within 6 hours after opening. Deaths from toxic shock have resulted when vials were retained for subsequent sessions.

If children have not received vitamin A during the previous month, all children of 12 months of age or older should receive a prophylactic oral dose of 200,000 international units (IU) of vitamin A. Infants less than 12 months should receive 100,000 IU. This should be repeated every 6 months as part of the routine vitamin A supplementation schedule. Children with measles, and adults and children with signs of vitamin A deficiency such as night blindness or bitot spots should be given treatment doses.

2. **Case Treatment.** No treatment specifically for measles is available. Supportive treatment of symptoms, such as fever and diarrhea, is recommended. Routine treatment with antibiotics to prevent secondary infection with bacterial pneumonias is not recommended. Vitamin A should be given and therapeutic or supplemental feeding may be necessary.
3. **Isolation.** Patients with rash and fever illnesses should be removed from high-density areas, patient waiting areas, and feeding care areas where nonimmunized susceptible patients are present. Isolation is a priority wherever possible and when widespread exposure has not already occurred. A shaded and well-ventilated area away from vulnerable populations may need to be established, particularly if dealing with large numbers of cases.
4. **Epidemic measures.** Emergency vaccination campaigns often inadvertently immunize persons who have already been infected and thus already have immunity. An analysis of cases by date, exposure history, geographic area, previous vaccination history, and tracking of case fatality rates may identify pockets that could be successfully immunized, and help evaluate efforts.
5. **Outbreak threshold.** One case.

(7) Malaria

Identification. Malaria is a protozoal parasitic infection of red blood cells, spread by mosquitoes. The disease

can have many presentations, but is typically characterized by headaches, high fever with chills, malaise, and sweats that can progress to kidney and liver failure, shock, and even coma. Malaria, when present, may be a leading cause of death, illness, miscarriages, clinic visits, and hospitalization. Children, pregnant women, immunocompromised individuals, and malnourished individuals are particularly at risk. Populations arriving from non-malarious areas to areas where malaria is endemic may experience higher attack rates due to a lack of immunity.

Part of the disaster assessment should be determining whether malaria is endemic in the region where DPs are currently located, as well as the regions from which persons have been displaced; the species of mosquitoes present; breeding seasons and types of malaria; patterns of drug resistance; national norms of diagnosis and treatment; experience with treated bed nets (long-lasting treated nets should be used) and indoor residual spraying programs (must be started at the onset of an outbreak to be effective in outbreak control); availability and use of intermittent preventive treatment; and laboratory capabilities available for public health confirmation and individual case management. The population's experience, understanding, and access to preventive and therapeutic norms should also be explored.

Infectious agent. Four species of human malaria exist: *Plasmodium vivax*, *Plasmodium falciparum*, *Plasmodium malariae*, and *Plasmodium ovale*. *P. vivax* and *P. falciparum* are the most common. *P. falciparum* has the highest case fatality rates and requires prompt treatment.

Occurrence. Tropical areas throughout the world. *P. falciparum* is rare in the Americas.

Mode of transmission. Various species of mosquitoes of the genus Anopheles. Malaria may also be transmitted by injection or transfusion of blood from infected persons or by the use of contaminated needles and syringes. Congenital transmission occurs rarely, but stillbirth from infected mothers is more frequent.

Incubation period. The time between the infective bite and the appearance of clinical symptoms is approximately 7 to 14 days for *P. falciparum* and 8 to 14 days for *P. vivax*.

Communicability period. For infectivity of mosquitoes, as long as infective sexual forms (gametocytes) of the plasmodium organism are present in the blood of patients. This varies with the species and strain of the parasite and with response to therapy. Untreated or insufficiently treated patients may be a source of mosquito infection for 1–2 years in *P. vivax* malaria, and generally not more than 1 year in *P. falciparum* malaria. The mosquito remains infective for life.

Susceptibility and resistance. Young children and pregnant women are more vulnerable, even in areas of high transmission, where the overall population may have semi-immunity.

Disaster implications. Malaria outbreaks are common during complex emergency situations where populations are moving from areas of low transmission to areas of high transmission. Such populations are vulnerable because they do not have immunity, and they are often more susceptible to infection due to their difficult circumstances. Populations impacted by complex emergencies often exhibit high rates of malnutrition, HIV/AIDS, and other infections that make them more vulnerable to malaria outbreaks. Malaria outbreaks are also common both after severe floods (more pools for mosquito breeding), and after a prolonged drought, as mosquito eggs can stay in the soil during dry periods and hatch once water is available.

Outbreak threshold. No specific definition exists; however, an increase in the number of cases above what is expected for the time of year among a defined population in a defined area may indicate an outbreak.

Methods of control.

- 1. Preventive measures.** Preventive measures should be directed to preventing mosquito bites. These include the use of long-lasting insecticide-treated bed netting and tarpaulins, wearing protective clothing, and control of mosquitoes through insect abatement programs such as indoor residual spraying. Programs such as larvaciding are not generally effective during the acute stages of an emergency because locating and treating all potential breeding sites in an unstable

emergency situation is extremely difficult. Where capacity exists, pregnant woman and children should be given intermittent preventive treatment with an antimalarial appropriate to local drug resistance patterns.

2. **Case Treatment.** In disasters, the diagnosis of malaria is often made clinically; however, take advantage of Rapid Diagnostic Tests (RDTs) for malaria diagnosis during emergencies because laboratory facilities are often unavailable or are overwhelmed. Symptomatic diagnosis of patients presenting with fever is often incorrect, and leads to incorrect treatment of patients with expensive therapies, wasting valuable time and resources. Microscopy or other laboratory tests should be used wherever available. Nevertheless, in an affected area without microscopy or available RDTs, assessments should address whether fevers of unknown origin and/or fevers with or without altered states of consciousness should be treated presumptively for malaria. The use of RDTs should be made a priority for effective diagnosis.

Of critical importance during potential outbreaks in disaster settings is to work with the Ministry of Health, WHO, the United Nations Children's Fund (UNICEF), and other key partners to ensure that appropriate drugs are being used to treat patients. In most cases where significant resistance occurs to drugs such as chloroquine, Artemisinin Combination Therapies are indicated. The use of Intramuscular Artemether and Rectal Artesunate saves the lives of patients with severe falciparum malaria who do not have immediate access to healthcare facilities. Avoiding the use of malaria-treatment drugs in cases where the malaria parasites have acquired resistance is extremely important. Artemisin-based drugs must be used in combination with other drugs except in specific indicated circumstances, to preserve the efficacy of these drugs. Drug resistance patterns should be monitored.

(8) Meningococcal Meningitis

Identification. Meningitis is an infection of the fluid and lining surrounding the brain spinal cord. High fever, headache, and stiff neck are common symptoms of meningitis. These symptoms can develop over several

hours, or they may take 1 to 2 days. Other symptoms may include nausea, vomiting, photophobia, confusion, and sleepiness. The term “meningococcal meningitis” refers to meningitis caused by *Neisseria meningitidis* (meningococcus), which is responsible for epidemics, particularly in Sub-Saharan Africa. Meningitis caused by other organisms should be ruled out before identifying the infection as meningococcal meningitis.

Infectious agent. *N. meningitide*, diverse types.

Occurrence. Different types of meningitis have peak occurrences at different times of the year, and in different places. The incidence of meningococcal disease peaks in the winter, with seasonal risk of meningococcal disease epidemics in parts of West Africa, primarily during the dry season.

Mode of transmission. Bacterial forms are transmitted through the direct exchange of respiratory and throat secretions.

Incubation period. Depends on the specific agent.

Communicability period. Depends on the specific agent.

Susceptibility and resistance. Susceptibility to the clinical disease is low and decreases with age; a high ratio of carriers to cases prevails.

Disaster implications. Crowded living quarters may increase transmission.

Outbreak threshold. In stable populations greater than 30,000 people, an outbreak threshold of 15 cases per 100,000 persons per week is indicative of a potential severe outbreak. In populations of fewer than 30,000 people, the threshold is five cases per week or a doubling of the number of cases over a 3-week period.

Methods of control.

- 1. Preventive measures.** Quadrivalent, monovalent, and polyvalent vaccines are currently available to prevent meningococcal meningitis caused by serogroups A, C, Y, and W135. Therefore, the cases must be laboratory confirmed before starting any vaccination program.

2. Case treatment. All bacterial forms, especially meningococcus, should be treated aggressively with antibiotics. A single injection of long-acting chloramphenicol in oil has been proven effective in meningococcal epidemics. Penicillin, ampicillin, and chloramphenicol are also effective but require multiple doses and in severe cases, IV administration.

(9) Tuberculosis (TB)

Identification. Tuberculosis is a mycobacterial disease that is a major cause of disability and death in many parts of the world. The initial infection usually goes unnoticed; tuberculin skin test sensitivity appears within 2 to 10 weeks. The initial infection may progress directly to pulmonary tuberculosis or to other serious outcomes. Serious outcome of the initial infection is more frequent in infants, adolescents, young adults, and the immunosuppressed.

Infectious agent. *Mycobacterium tuberculosis*.

Occurrence. Worldwide.

Mode of transmission. The most common route of transmission is inhalation of the bacilli from prolonged personal contact with a person with pulmonary TB. Effective chemotherapy in HIV negative persons usually eliminates communicability within a few weeks, although treatment may need to continue for 6 months or longer. Untreated or inadequately treated people can be infectious for years.

Incubation period. About 2 to 10 weeks.

Communicability period. Persons should be considered infectious if laboratory tests determine the presence of acid-fast bacilli in the sputum. Generally, nonpulmonary TB patients do not pose a risk to the general population.

Susceptibility and resistance. Ten percent of healthy persons will develop TB disease after being infected. Persons with immune systems weakened by HIV/AIDS, cancer, age, or malnutrition will develop disease at much higher rates. Disease from Multi-Drug Resistant TB (MDR-TB) and untreated TB has a case fatality rate of 50 percent.

Disaster implications. Because TB is considered an opportunistic infection of HIV/AIDS, a greater risk of increased TB infections is associated with disasters that occur in countries with high HIV/AIDS prevalence. A first priority for treatment in disasters is to identify and resume therapy for individuals already undergoing treatment. Failure to complete treatment may spread drug resistant organisms in the population. The decision to establish therapy in other persons who have not begun treatment will depend on the ability to provide monitored therapy through completion. These therapies have been achieved in difficult settings but should be decided on a situation-by-situation basis.

Methods of control.

- 1. Preventive measures.** Promptly diagnose and treat potentially infectious persons with TB disease, and establish case finding and treatment programs for those with the disease. Use of prophylactic therapy will depend on the available resources and ability to track patients.
- 2. Case treatment.** Treatment norms should be established in conjunction with WHO and national norms and should be adhered to by all agencies offering therapy. Inappropriate therapy is more dangerous to public health over the long term than no therapy due to the risk of drug resistance.

4. Health Care Provision

Health care in emergency settings generally provides both preventive and curative services. Curative measures vary depending on the emergency and the amount and quality of preventive care. A limiting factor for the expansion of services is often not the lack of trained personnel, but the lack of adequate quantities of water and facilities for safe reprocessing of equipment. Inpatient care facilities can amplify the presence of infections ranging from MDR-TB to Ebola to cholera to measles, and inpatient facilities should only be established if they can be done safely and cost effectively.

Particularly where several organizations are involved, close attention must be paid to ensure a common standard of appropriate health care. Standardized and evidence-based treatment

schedules are essential. In the absence of diagnostic capabilities, syndromic protocols that have been validated for sensitivity and specificity can be used. Unless treatment is administered immediately, clear oral and written guidance on the dosage and schedule must be given to each patient in his or her native language. In addition, organizations should work together to ensure a fair distribution of available services.

Treatment that is inappropriate for people's needs and circumstances can be useless and wasteful, and can also have a negative effect on their attitude toward health care and preventive measures in general.

To the greatest extent possible, the affected population should be given responsibility for their own health. Outside health workers must understand the population's own beliefs regarding health and disease. Services should be operated with, rather than for, the affected population. If not, health care services will be less effective, may be distrusted by the population, and are likely to collapse when expatriate staff leave.

a. Health Care Personnel

Strong emphasis should be placed on the training and upgrading of the clinical skills of selected health workers, particularly those who already have health-related roles in the community (e.g., traditional healers and midwives). Even persons with no prior experience can be very effective health workers in settings with supervision, well-defined responsibilities, and a scope of action limited to tasks that can be done safely.

As a general principle, the order of preference for selecting health personnel is (1) members of the affected population, (2) experienced nationals or residents, and (3) international relief personnel. Most emergencies will require some combination of these sources. Personnel selections should be made in cooperation with the national services. An important consideration may be the government's attitude toward foreign medical personnel, including the recognition of qualifications and authority to practice medicine.

In a major emergency, a health coordinator may be assigned responsibility for planning and developing appropriate health care programs, establishing standards, monitoring the quality of services, and ensuring proper liaison and coordination

among the health ministry and other international organizations on health matters.

b. Levels of Health Care Treatment

In emergency situations, the population must be able to access appropriate treatment. In most emergency settings, access to centralized health care is problematic. If basic health care facilities are not readily available, hospitals or major health centers can be swamped by patients demanding treatment for simple conditions that could have been treated elsewhere. What is required, therefore, is a community-based health service that identifies and treats those in need of health care and provides that care at the appropriate level.

Sphere standards should be followed for ratios of health facilities to population and staffing per health facility. For example, there should be one community health worker per 500 to 1,000 population; one skilled/traditional birth attendant per 2,000 people; etc.

The first level of health care in emergency settings is provided by the community health worker (CHW), who is responsible for a section of the population and works among them to provide outreach services such as home visits, case finding, and followup. CHWs can track births and deaths in the population, the emergence of new issues and concerns, and be a link between providers and patients. They can also implement basic communitywide preventive measures, including transmission of public health messages, distribution of health commodities such as bednets, condoms, or iron tablets, and provide directly observed TB therapy. CHWs can provide identification of health and nutritional problems, and refer patients to a clinic if simple on-the-spot treatment is not possible. Disease information gathered from the homes or representative samples is often more important than clinic-based information, which does not represent the entire population.

The second level of health care is a local health facility. According to Sphere standards, one health facility should be established for every 10,000 people, with a total of two to five staff. The staff should include a minimum of one qualified health worker (i.e., a formally trained clinical provider, nurse, doctor, medical officer or medical assistant) providing about 50 consultations per day, assisted by two to three health

workers who provide ORT, dressings, registration and admissions, etc. In acute emergencies with mortality above 1 per 10,000 people, it will be necessary to have separate supervisors for the CHWs providing outreach and for the staff providing clinical services.

Hand washing facilities with soap, water and a means of drying hands are the minimal requirements needed to reduce the spread of disease between patients. Large volumes of potable water, latrines, and a waste area for feces, body fluids, and medical waste are essential services at all health facilities. An incinerator should be established for burning medical waste and sharps (used needles). Alternatively, sharps containers may be transported to another location for final burial or destruction.

The third level of health care would be a central health facility (for a population of approximately 50,000 people) with a minimum of five qualified health workers, including one physician. There should be 24-hour services for inpatient care; one qualified health worker for outpatient services; one qualified health worker per 20 to 30 beds; one non-qualified worker for ORT; one to two for pharmacy; one to two for dressings, injections, sterilization; one lab technician; and several non-qualified workers for registration, security, etc.

The next level of health care is the referral hospital. Essential services required at this level are the ability to attend to births and cases requiring inpatient care. Ideally, it should also provide emergency obstetrical care, blood transfusions, therapeutic feeding programs, minor surgical procedures, referral cases that could not be handled at a lower clinic level, as well as general reproductive health services. Staff should be assisted by one doctor with surgical skills; one nurse is needed for 20 to 30 beds per shift.

With the exception of short-term, self-contained emergency trauma and burn hospitals that accompany search and rescue teams, the establishment of special hospitals for populations affected by a disaster should generally be avoided. Hospital-level care is not cost effective, as it requires enormous volumes of water and energy, is skilled-labor intensive, provides only curative services, rarely continues to function once outside support is withdrawn, and is inappropriate for long-term needs. Once established, special hospitals are extremely

difficult to close without creating ill will. Therefore, special hospitals should be provided only if a clear and continuing need exists that cannot be met by existing national hospitals. If the need for such a special hospital exists (e.g., to treat time-limited outbreaks such as cholera), the number of beds required would depend on the condition of the population. For example, one bed might be required per 2,000 people in the early stages of an emergency, requiring two doctors and six nurses plus auxiliary support.

5. Health Education

The importance of health education is widely accepted. It may be a difficult task, however, to persuade at-risk populations to change long-established habits that increase their health risks. During the emergency phase, priority topics of any health education program should be directly related to immediate public health problems, such as the disposal of human excreta and refuse or disease prevention. Trained teachers from the population and respected elders are likely to be more effective than outsiders in communicating basic health principles and practices.

6. Medical Supplies

Emergency medical supplies should draw on in-country resources to the greatest extent possible, if supplies consistent with international norms (e.g., WHO, UNICEF) are available.

a. The New Emergency Health Kit

WHO has a standard list of essential drugs and medical supplies for use in an emergency. They are packaged together in the New Emergency Health Kit, which has been accepted by many organizations and national authorities as a reliable, standardized, inexpensive, and quickly available source of essential drugs and health equipment needed in an emergency situation. **Its contents are calculated to meet the needs of a population of 10,000 persons for 3 months.**

The kit consists of two different units of drugs and medical supplies: the Basic Unit (10 per kit) and the Supplementary Unit (1 per kit).

The Basic Units contain oral drugs, medical supplies, treatment guidelines, and some simple equipment for use by

basic healthcare workers with limited training. Each Basic Unit weighs 45 kg and occupies 0.2 m³.

The Supplementary Unit is designed for use by trained health workers serving a population of 10,000 people for 3 months. The Supplementary Unit, which should be used with a Basic Unit, contains injectable drugs, IV fluids, IV tubing and catheters, nasogastric tubes, syringes, minor surgical equipment, essential infusions, supplies, and equipment. The Supplementary Unit weighs 410 kg and occupies 2 m³.

The total New Emergency Health Kit, including the 10 Basic Units and 1 Supplementary Unit, weighs about 860 kg and occupies 4 m³. An entire kit can be transported using a standard pickup. It should be noted that these kits are designed to meet only initial needs pending the establishment of a regular system for medical supplies.

Basic equipment for pelvic exams and deliveries is provided in a separate Minimum Initial Services Package for reproductive health.

Medical supplies can also be ordered through the UNICEF supply warehouse that has a stockpile of prepackaged drugs and supplies. These supplies must be ordered through OFDA/W, not directly from the field.

b. Vaccines

Vaccines should be provided in conjunction with national-, UNICEF-, or WHO-sponsored programs. The provision of supplies through local procurement channels should be explored. Before immunization, careful planning should determine whether the vaccines will have vaccine vial monitors that detect heat exposure; the need for freeze indicators for freeze sensitive vaccines (tetanus toxoid, tetanus toxoid with reduced diphtheria content, DTP, hepatitis, and Hib pneumonia); and the availability of cold packs, vaccine carriers, cold boxes, existing cards, single-use syringes, sharps containers, cotton, thermometers, and other required supplies. Most vaccines require protection from excessive heat exposure and some require protection from freezing.

Temperature logs should be posted on refrigerators and freezers. Temperatures should be checked twice daily and noted on cards accompanying the vaccine. Storage facilities located at the central (capital city) and regional level should have temperature alarms and backup (emergency) generators.

Vaccines should be stored on central shelves and not in refrigerator doors. Take into account also the time needed to clear customs.

c. OFDA Guidelines for Pharmaceutical Donations

OFDA/W, Assessment Teams, and DARTs may receive offers of pharmaceutical donations from a variety of organizations. Often, these organizations also seek assistance in transporting the donated products. OFDA/W will normally work directly with the organizations regarding transport issues, but will often request Assessment Teams and DARTs to validate the field requirement for the pharmaceutical product and ensure the capability of the identified consignee to receive, transport, store, distribute, and monitor the use of the product. Clearance for medical and pharmaceutical products is granted if these goods meet the criteria specified by OFDA, and are listed in the WHO Guidelines for Drug Donations. Assessment Teams and DARTs should use the following criteria to ensure objective and consistent field input on whether to accept or reject donated pharmaceutical products:

- Donations must be based on an analysis of needs.
- The proposed product is appropriate to the disaster situation and the objectives of the program.
- Product selection and distribution must conform to existing policies and capabilities (adherence to any existing national policies, the WHO Essential Drug List, etc.).
- Products must be easily identified through labels and written materials.
- The shelf life must allow time for transportation and distribution. The expiration date must be at least 12 months in the future of the products' arrival in the recipient country (an expiration date of less than 12 months may be allowed on a case-by-case basis, upon approval by the OFDA Health Officer tracking pharmaceuticals).
- Unsolicited and unnecessary donations are wasteful and should not be encouraged.

F. Shelter and Settlements

1. Background

In most countries, people consider shelter their most important economic asset. Shelter is also critical to both sustaining life and supporting productive activities. Shelter is, therefore, more than just a house; it can also be an office, shop, factory, warehouse, granary, and barn. Furthermore, shelter provides an excellent means of understanding a country's society, culture, economy, and politics. If one can "read" shelter (or more accurately, shelter markets) one will have some understanding of a society's group, gender, and generational relations, the value placed on environmental management, and the economic and political power wielded by various groups.

Shelter and related support services are key features of settlements because of the economic, social, and cultural importance of shelter and the fact that shelter and services typically occupy a majority of the land in larger settlements. In their simplest form, settlements are concentrations of people in physical space. Settlements range in size from the smallest hamlets to the largest "mega-cities" of 10 million or more people. Therefore, separating shelter from the larger context of settlements is all but impossible, and the natural hazards and resource issues that are often the source of disasters and conflicts. Shelter sector activities are an excellent means of addressing these important issues.

This section will provide information on shelter and settlements interventions, discuss the important role that shelter can assume in promoting livelihoods and reducing the impacts of disasters and conflicts, and discuss the components of camp development in the event that other, more cost-effective interventions are not possible.

2. Shelter Interventions

Where settlements, and the houses within them, are located, how they have developed physically over time, how rapidly they have grown, how strong and inclusive their economies are, and how well they are managed, especially in times of crisis, will largely determine whether they become the sites of future disasters and conflicts. Settlements located in floodplains, for

example, will be subjected to floods, while settlements that do not provide equal opportunities and services for all residents may be the sites of future conflicts.

Damage to settlements and housing caused by natural disasters or human-caused conflicts may require a wide range of responses. These responses may include provision of plastic sheeting and related relief materials, provision of assistance to guest families and host families and communities, provision of transitional assistance designed to address pressing needs while also jump-starting the reconstruction process, or provision of camp settlements. Some of these response options can be the basis for multisector efforts designed to link relief and development activities, often through measures aimed at reducing the impact of disasters.

Shelter needs should not be derived or assumed based on damage assessments alone, but also through interaction with affected populations. Therefore, timing, participation, and needs are critical elements of any intervention. Shelter is one of the most important determinants of general living conditions. Although the basic need for shelter is similar in most emergencies, considerations such as the kind of housing needed, what materials and design are used, who constructs the housing, and how long it must last will differ in each situation.

A key objective of any shelter sector intervention should be the timely provision of safe, secure, private, and habitable shelter that provides protection from the elements. *The intervention should feature the provision of covered living space of at least 3.5 m² per person, cognizant that expansion is probable as part of a future, incremental construction process.* The covered living space provided should enable separation and privacy between the sexes, between different age groups and between separate families within a given household, as needed. Further, the space provided should accommodate new or pre-disaster/crisis livelihood activities within the shelter. Achieving this objective often requires a coordinated effort among donors, NGOs, local and national governments, and affected populations.

Lack of adequate shelter and clothing can have a major adverse effect on the health and nutritional status of displaced people. Thus, in addition to shelter, the provision of sufficient blankets, appropriate clothing, and possibly heaters will be a high priority.

Neither prefabricated buildings nor specially developed emergency shelter units have proved effective in DP emergencies due to their relatively high unit costs, transportation requirements, and inflexibility. Also, emergency shelter arrangements are likely to have been constructed before such systems arrive. For similar reasons, tents are often not an effective means of providing shelter. They are difficult to live in and provide little insulation from temperature extremes. Tents, however, may be useful for DPs of nomadic origin or when local materials are not available or are only seasonally available. If tents are used, repair materials should be provided.

The best way to meet emergency shelter needs is to ensure the availability of materials or shelter similar to those normally used by the displaced population or the local population. Only if such materials cannot be acquired locally should emergency shelter material be brought into the country.

Shelter must be available so that other services can be developed properly. Emergency materials should be reusable for the construction of improved housing wherever possible. Where local materials are in short supply or have a short life, consider acquiring more permanent materials. Fire-resistant materials may be needed in areas with a high density of shelters.

The key to providing adequate shelter is the roof. If materials for constructing a complete shelter are inadequate, priority should be given to constructing a roof. Walls can be made of earth or other materials found onsite location or made locally available.

Housing should meet the cultural and social requirements of the DPs. Familiar housing will help reduce the disorientation and emotional stress suffered by the displaced population. To the extent possible, longer term housing must be similar in design and construction to that with which the DPs are familiar, while reflecting local conditions and practice. This process will generally mean single-family shelters, unless the DPs are accustomed to multifamily units. Although more costly, the benefits of individual homes for the displaced population cannot be overstated. The risk of communicable diseases increases enormously in communal shelters. Experience has shown that social and environmental problems may also rise if people live in large, multifamily shelters. Also, buildings made from local materials may be approaching their structural limits at this size.

Materials and design should meet the minimum technical standards for the local seasons. For example, roof material must be strong enough to withstand damage by the sun, rain, snow, and winds. OFDA-supplied plastic sheeting has been very effective as roofing material; see the plastic sheeting section of appendix B for more information. Raised flooring is required in areas of high rainfall. Wall material must afford privacy and protection from the elements. If the site lies in a hazard-prone area (e.g., an area subject to earthquakes or cyclones), the design of buildings and their siting should conform to hazard-resistant criteria. In buildings where cleanliness and hygiene are particularly important, the floor should be cement or at least washable.

Even emergency shelter, including communal buildings, should be built by the DPs, provided adequate organization and material support is given. Using DPs for construction will help ensure that housing will meet their particular needs. Work by DPs will reduce their sense of dependence and can cut costs considerably. Where beneficiaries are unable to engage in self-help, shelter assistance can be provided by adopting either an assisted self-help or fully contracted mode of delivery.

Questions to consider when identifying shelter interventions include the following:

- What shelter solutions have affected populations adopted in the immediate aftermath of a disaster or conflict? To what extent can these solutions serve as the basis for assistance from the humanitarian community?
- Do opportunities exist to support families and communities who are willing to host affected people, often for an extended period of time?
- Are interventions constrained by the onset of seasonal change? Is winter, or the rainy season, approaching, for example, thereby requiring a rapid response?
- To what extent are the needs of the most vulnerable (e.g., those located on hazard-prone lands, and/or the poor, squatters, renters, young, elderly, handicapped, and displaced, reflected in damage and impact assessments)? Have these groups participated in the design of survey work, damage assessments, and identification of proposed responses?
- Have local homebuilding industry capacities and capabilities been examined? What is the availability of local building

materials? What are industry constraints? Can local sources of labor and materials support shelter repair and upgrading programs? Are imported materials such as plastic sheeting needed to supplement local materials?

- To what extent can homebuilding industry engagement in repair activities help stimulate economic recovery/growth, particularly with regard to the generation of livelihood opportunities?
- Have opportunities for mitigation and prevention of future disasters been identified? Are efforts to identify “harm’s way” and keep people out of it integral components of the analysis? If seismic hazards are present, for example, does shelter assistance include incorporation of seismic-resistant design measures, and provide hazard mapping for emergency and reconstruction planning?
- Have opportunities for linkages to other sectoral activities (e.g., livelihoods, services, environmental management) been identified? Are these opportunities reflected in proposed interventions?
- Emergency shelter activities often provide a framework for subsequent transitional reconstruction efforts, including the incorporation of disaster reduction measures. What linkage opportunities are incorporated into proposed interventions that link emergency work to longer term efforts?
- To what extent do relevant government authorities support proposed actions? How are government reactions evidenced? What role is identified for local governments/organizations?
- In addition to these guidelines, are Sphere Project Guidelines for shelter sector activities reflected in proposed interventions? These guidelines specify universally recognized levels of service, and should be supported wherever possible and appropriate.

The monitoring and evaluation of shelter interventions must not merely report on the number of damaged houses, or catalogue the amount of shelter material that was distributed, but rather how many people need shelter assistance, and how many received shelter assistance as a result of material distributions.

3. Camps: When Other Shelter Interventions Are Not Possible

Although circumstances may make DP camps unavoidable, the establishment of camps must be a last resort, because of the high cost and many problems associated with both camp development and operations. The location of a DP camp may range from a spontaneous settlement over a wide area, to an organized rural settlement, to a concentration in a very limited area. A solution that maintains and fosters self-reliance among the displaced population is always preferable.

If no immediate solutions arise to resolving the causes of displacement, planning for the DPs' needs should assume a long-term outlook. Temporary arrangements can be difficult to change once they are established. Site selection, planning, and the provision of shelter have a direct bearing on the provision of other assistance. They are important considerations in the overall assessment of needs and the planning of emergency response.

Decisions must be made as part of an integrated approach taking into account advice from experts, and views of displaced people.

Expertise may be required in the fields of geology, shelter/settlements, planning, engineering, and public health. Familiarity with local conditions in both the DPs' area of origin and their present location is important, as is previous experience in similar emergency situations.

There may be a need to set up a reception or transit center through which DPs pass on the way to a longer term settlement site. These centers must have the same considerations as those relevant to long-term settlements.

Planned temporary settlements or self-settled camps should feature a minimum surface area of 45m² per person. The surface area planning guideline of 45m² per person includes household plots and space for roads, foot paths, educational facilities, sanitation, firebreaks, administration, water storage, distribution areas, markets and storage, plus limited gardens for individual households. Area planning should also consider possible future growth. If the minimum surface area cannot be provided, consideration should be given to mitigating the consequences of the higher density to ensure adequate separation between individual households and space for required facilities.

a. Criteria for Site Selection

(1) Social Needs

If possible, the social and cultural backgrounds of the displaced population should be considered when determining a camp location. In most circumstances, however, the choice will be limited, and any land that meets even minimum standards may be scarce. Once a site is located, determine why the site was not already in use and examine whether the reason (e.g., no water or because it floods in the monsoon period) would exclude use by DPs.

(2) Water

The single most important site-selection criterion is the availability of an adequate amount of water on a year-round basis. This most important factor is also commonly the most problematic. A site should not be selected on the assumption that water can be acquired merely by drilling, digging, or hauling. Drilling may not be feasible and may not provide adequate water. No site should be selected where the hauling of water will be required over a long period. A professional assessment of water availability should be a prerequisite in selecting a site.

Where water is readily available, drainage is a key criterion. For effective drainage, the entire site should be located above flood level at a minimum of 3 m above the water table, preferably on a gently sloping area. Flat sites can present serious problems for the drainage of waste and storm water. Marshes or areas likely to become marshy or soggy during the rainy season should be avoided. Conditions within the watershed may be a consideration.

(3) Open Space

The site must provide a sufficient amount of usable space for the displaced population to engage in communal and agricultural activities, livestock husbandry, or other activities (e.g., recreation, meeting spaces, etc.). Although camp planning should be based on a known design capacity (e.g., shelter and other facilities sufficient for, say, 20,000 people), the possibility always exists that more people may arrive. To the extent possible, the site should be planned to accommodate a major influx of additional people. If the population has been displaced because of civil strife, the site should be removed from areas of potential conflict.

(4) Accessibility

The site must be accessible by vehicles and close to communication links and sources of supplies and services such as food, cooking fuel, shelter material, and national community services.

(5) Environmental Considerations

The area should be free of major environmental health hazards such as malaria, onchocerciasis (river blindness), schistosomiasis (bilharzia), or tsetse fly. Climatic conditions should be suitable for habitation throughout the year. For instance, a suitable site in the dry season may be unusable during the rainy season. While a daily breeze is an advantage, strong winds may damage emergency and temporary housing, especially tents. To the extent possible, DPs should not be settled in an area where the climate differs greatly from that to which they are accustomed.

(6) Soil and Ground Cover

The soil should allow for water absorption and the retention of human waste. Rocky or impermeable sites should be avoided. If possible, land suitable for vegetable gardens and small-scale agriculture should be selected for the site.

The site should have a good groundcover of grass, bushes, or trees, as covering vegetation provides shade and reduces erosion and dust. During construction of the camp, care should be taken to cause as little damage as possible to the vegetation and topsoil. Bulldozers, if used, should avoid scrapping topsoil off the site, as often occurs. If wood must be used for domestic cooking fuel, it should not be taken from vegetation on the site.

Alternative sources of fuel must be found as soon as possible to avoid irreplaceable loss of surrounding wood.

(7) Land Rights

The land should be exempt from ownership, grazing, and other uses by local populations. Using such land can be a cause of local resentment. Authorities proposing the site may be unaware of customary rights exercised by local populations. Sites are often provided on public land by the government. Any use of the land must be based on formal legal arrangements in accordance with the laws of the country.

b. Site Planning

Following are some general things to consider during site planning:

- At the onset of an emergency, the immediate provision of essential goods and services is more important than efforts to change the way people have already arranged themselves.
- Site planning should account for the potential need for expansion.
- Site planning should first consider the characteristics and needs of the individual family and reflect the wishes of the community as much as possible, particularly the needs of female-headed households.
- The overall physical layout and other aspects of a site should reflect a decentralized, community-based approach focusing on family, village, or ethnic group, rather than a grid-based design that can be costly and inefficient, and can undermine social networks and safety objectives.

(1) Latrines

Although water requirements often determine site selection, sanitation requirements can dictate the site layout. If latrines are used, there should be at least one for every 20 persons. They should be located no less than 6 m, and no further than 50 m, from any house. If latrines are too far away, they will not be used. Sufficient space must be provided for replacement latrines. If communal latrines are unavoidable, they should be accessible by road to facilitate maintenance. To avoid contaminating water sources, latrines should have an effective drainage system that is easy to repair, both for rainwater and wastewater. Latrines should be located at a minimum distance of 30 m from water sources.

(2) Water Distribution

Where possible, the maximum distance between any house and a water distribution point should be no more than 500 m or a few minutes' walk. Water will often be pumped from the source to an elevated point to allow gravity-fed distribution. Planning of the site should take this into account.

(3) Roads and Pathways

The site should be accessible from other sites and contain all-weather roads and pathways connecting the various areas and facilities. Roads should be built above flood level and have adequate drainage. If significant vehicle traffic will occur on the site, it should be separated from foot traffic.

(4) Firebreaks

Within a DP camp, build a firebreak (an area with no buildings) 50 m wide approximately every 300 m of building area. This area can be used to grow vegetables or for recreation. If space allows, the distance between individual buildings should be great enough to prevent collapsing burning buildings from touching adjacent buildings. The direction of the prevailing wind should be a consideration.

(5) Administrative and Community Services

At the onset of an emergency, it may be difficult to foresee all the administrative and community services likely to be required. Underestimation of the space required for future communal needs is a common problem in camps of limited area. Therefore, where adequate space is available, free areas must be allocated for future expansion of these services. The following lists indicate administrative and community services that are often required.

Likely to be centralized:

- Camp administrative office.
- Essential services coordination offices (health care, general feeding programs, water supply, education).
- Warehousing and storage.
- Initial registration/health screening area.
- Tracing service.
- Therapeutic feeding center, if required.

Likely to be decentralized:

- Bathing and washing areas.
- Community services (health centers, social service centers).

- Supplementary feeding centers (if required).
- Education facilities.
- Institutional centers (such as for the disabled or unaccompanied children), if required.

(6) Physical Layout

Camps are often similar in size to mid-size cities of 20,000 or more people, and contain many of the basic functions of cities. Cities typically have several neighborhoods or other subdistricts, and a basic principle of any physical layout of a camp should reflect this form of social and economic organization by dividing the camp into small community units or villages organized around the centralized core services. Each community unit would contain the decentralized community services mentioned above. Area or cluster planning by family, neighborhood or village groups as appropriate supports existing social networks and enables self-policing by the affected population.

The location of centralized services will depend on the specific situation and, in particular, the space available. Where space is available, it may be advantageous to have the centralized services located in the physical center of the camp. Where space is scarce, it may be better if centralized services are located near the entrance to the site. This will allow trucks to avoid driving through a densely populated camp. Whatever the layout, warehouses should be located near the administrative office for security reasons.

The linear, or grid, layout, with square or rectangular areas separated by parallel streets, is often used. The grid has a simple design, is quick to implement, and allows a high population density. It should be avoided, however, because environmental health problems and disease are directly proportional to population density. In addition, site preparation and development costs are generally greater than a cluster-oriented layout. Furthermore, a rigid grid design makes the creation of community identity difficult, because the displaced people are not usually accustomed to living in such a pattern, and might result in social dislocation, alienation, and a host of other adverse social conditions.

G. Sanitation and Environmental Health Services

1. General

While the discussion in this section emphasizes DP camps to a great extent, most of the material is also applicable to assisting with the sanitation concerns of small communities impacted by disaster or conflict. The disruption and overcrowding of people accustomed to living in less crowded conditions in their own homes makes sanitation a critical issue. Indiscriminate disposal of human excreta and other waste products poses serious threats to the health of individuals, families, and the community. In a DP emergency, sanitation facilities to which individuals were accustomed are no longer available. Basic services are often lacking, and habits may have to be changed.

For this reason, an effective environmental health program must be established to include the following: provision of safe water; disposal of human excreta, wastewater, and garbage; insect and rodent control; safe food-handling practices; and site drainage. These services and the provision of health care are interrelated and should be considered together.

An acceptable and practical system for the disposal of human excreta is the key to reducing health hazards. The system must be developed in cooperation with the DPs and be culturally appropriate, even if circumstances necessitate a departure from traditional practices. The provision of special public health or hygiene education may be required to ensure that the system will be used by the displaced population.

2. Importance of Organization, Integration, and Selection

Environmental sanitation will be a very important consideration in campsite layout, and its organization and operation must be integrated with other community services. Expert advice should be sought from a public health engineer or environmental health specialist familiar with the habits of displaced people and the local population, and experienced with DP emergencies.

Good sanitation depends to a great extent on attitudes of the community and the people who run the system. The overall system and its services should be able to operate effectively with a minimum of outside involvement. Therefore, selected DPs must be trained to run the sanitation and environmental programs.

The most common cause of failure of a sanitation system is the establishment of the wrong system, often as a result of inadequate involvement of the camp population and a failure to take all relevant factors into consideration.

Breakdown of sanitation systems is often caused by inadequate maintenance, even for properly designed and installed systems. Poor maintenance will lead to latrine failures, contamination of the environment, and a high risk of infection and disease. Regular inspection and maintenance of latrines should be enforced. The best guarantee of proper maintenance is the allocation of latrines to individual families.

Even when in working order, latrines will not be used unless they are clean. Individual families should be responsible for the cleanliness of their own units. If communal latrines are unavoidable, the camp management must establish an effective program of latrine cleaning and maintenance, which may include compensating individuals who are responsible for keeping them clean and operational on a daily basis. Particular attention must be given to the maintenance and cleanliness of latrines serving community facilities such as feeding and health centers. It should be noted that disinfectants should not be poured into pits or tanks of latrines as these chemicals will interfere with natural biological degradation processes. Instead, the regular addition of soil, ashes, or oil may be used to control insect breeding and reduce odor.

A public health education program emphasizing the importance of sound sanitation practices should be established. The link between excreta contamination and disease must be clearly understood by all, including children. Children are the main excretors of many pathogens that cause diarrhea. Because children are often uncomfortable using unfamiliar latrines, particular care will be needed to ensure that latrines are safe and physically suitable for children.

3. Disposal of Excreta

Safe disposal of excreta is critical because agents of a large number of infectious diseases are passed from the body in excreta. These excreted infections fall into four main groups: viruses, bacteria, protozoa, and worms (helminths). Excreta, unless properly isolated, can also provide a breeding ground for insects, which may act as either direct or indirect transmitters of disease.

Links between diseases, infections, means of transmission, and the sanitation system must be kept under constant surveillance. But the links are not always the most obvious. For example, an important human link in transmission of an infection is the carrier who shows little or no sign of disease. Conversely, people in an advanced state of disease may have minimal impact on disease transmission, as those around them will be aware of the danger.

Human waste is more dangerous than animal waste; therefore, the safe disposal of human excreta is more important than the disposal of animal waste. Human feces are normally of much more concern than urine. In areas of Africa and the Middle East where the *Schistosoma haematobium* species of bilharzia exists, however, and in all areas where typhoid is common and endemic, proper disposal of urine is also extremely important.

a. Selection of a System—Immediate Considerations

The selection of an appropriate excreta disposal system requires consideration of a number of factors. In an emergency, however, time is the critical factor. Pollution of the environment by excreta, with all its attendant risks, cannot be stopped without immediate sanitation measures. Thus, the range of choices is always much more limited at the very outset of an emergency. Weeks or months cannot be lost in waiting for expert advice, construction to be completed, or material to arrive. In an emergency situation, provide systems to meet immediate needs, which can be improved or replaced later.

Emergency conditions may dictate at least the initial use of trench latrines. These can be dug quickly and need less space than individual family units. While very shallow trenches may be an initial quick solution, deeper trench latrines are much more effective. Where space and soil conditions allow, the simplest and most common individual family unit is the pit latrine.

Once a temporary system has been established, more time and care should be expended to establish the most appropriate waste disposal system. Two main factors will affect the choice of an excreta disposal system: the traditional sanitation practices of the displaced people and the physical characteristics of the area, including the geology, availability of water, rainfall, and drainage. Failure to take proper account of any of these factors can cause the system to

rapidly become a health hazard. Above all, cleanliness of latrines and their ease of access will determine whether or not they are used.

First, it must be determined how the DPs can modify their traditional practices to reduce health hazards during the emergency situation. More than 40 percent of the world's population does not have access to a sanitary form of excreta disposal. Traditional practices and other factors must be considered at the planning stage and will directly affect the type of system to be established. Other cultural factors to consider include:

- Previous sanitation system and practices.
- Method of anal cleansing.
- Preferred position (sitting or squatting).
- Need for privacy and security, particularly for women and children.
- Segregation of sexes and other groups or individuals with whom sharing a latrine is culturally unacceptable.
- Cultural practices for children.
- Cultural taboos (e.g., avoiding contact with anything that may have touched excreta of others).
- Social factors, including likelihood of community action to ensure proper use of proposed system.
- Cultural needs for special orientation (direction) of latrine.
- Systems used locally in neighborhood of site.

Arrangements must be made to ensure the availability of appropriate anal-cleansing materials and hand washing facilities at or near all latrines. Such facilities are essential for the maintenance of individual and community hygiene. Also, latrines must be safe for children and women and be accessible at night. For individual units, families may provide their own lamps, but some form of lighting should be provided for communal units. In some cases, guards may be needed near the latrines to ensure security.

b. Immediate Action

The first group of DPs arriving at a site should construct a disposal system adequate for their immediate needs. Without proper facilities, DPs are likely to defecate indiscriminately,

contaminating their environment and possibly their water supply. In consultation with community leaders, the first step is to localize excreta; that is, control indiscriminate defecation. If space allows, designate an area or areas away and downwind from dwellings, but accessible and in close proximity. Fence the area(s), ensure privacy, and provide a shallow trench and spades, if possible. Locate these areas where surface runoff during rain will not cause contamination to the shelter area or water sources, and protect them with cutoff ditches.

A publicity campaign will be required to encourage the population to use specified areas and not defecate indiscriminately near dwellings. Measures must also be taken to prevent defecation or urination in or near the water supply. Immediate action in both regards can significantly reduce public health hazards.

If the ground is flooded or marshy or has a high water table, arrangements must be made as soon as possible to physically contain the excreta. Under such conditions, the location of the area, away from dwellings and the water source, is very important. Pending a proper containment system, a simple raised structure (e.g., a wooden stage some 50 cm high) can prevent the population from contaminating their environment with excreta. Empty 200-L (45-gal) oil drums can also be used if one end of the drum is cut out and then inserted open end down into a hole that is as deep as the water allows, with the last half meter of the drum left aboveground. A small hole should be cut into the aboveground end of the drum to transform it into a squatting plate. These options should be viewed as very short-term sanitation interventions.

In hot, dry climates where sufficient space is available, localized defecation areas located away from dwellings may be the best short-term arrangement, as heat and sunlight render the feces harmless with time. Black rock is the best surface. Under these conditions, potential health hazards in the area (e.g., an increased number of rats) should be periodically reviewed.

If the camp is on the coast, DPs may choose to defecate in the water. While this practice is less harmful than to indiscriminately defecate on land, it should be discouraged unless no other option is available. The dangers of defecating in

the water increase greatly with numbers. Such practices contaminate the high-water line, and increase the health hazards of washing in the sea. Defecation in bays, estuaries, or lagoons where fish or shellfish are caught should be greatly discouraged, as this may be a source of infection in seafood.

c. *Longer Term Options*

For a number of reasons, expert advice is required to develop the most appropriate waste disposal system. The nature of the soil will be important; if the soil is highly impervious to water, some systems should be excluded from consideration. The availability of water and cultural considerations must also be considered. Many simple options, if properly constructed and maintained, will meet all public health requirements. In most emergencies, two main types of latrines are possible, even for DPs unaccustomed to them. The most common type is the dry latrine, such as a trench, pit, or hole in the ground. More elaborate pour-flush latrines use small quantities of water to flush wastes out of the toilet trap. Other systems are based on the composting of excreta.

d. *Latrine Styles and Considerations*

Three basic latrine styles are available: individual family units, centralized units with each latrine allocated to an individual family, and communal systems. Individual family units are the preferred solution, because people will always make more of an effort to clean their own latrine than they will to clean a communal facility.

To determine the most appropriate latrine style, consideration must be given to a number of factors, such as the number and siting of latrines, population density, soil, available water, drainage, and construction materials.

(1) Number and Siting of Latrines

As a rule, at least one latrine (drop hole) should be provided for every 20 people. Latrines should be located at least 6 m from dwellings, 10 m from feeding and health centers, and at least 30 m from wells or other drinking-water sources. Although all these distances depend on latrine and soil type, latrines should be located no more than 50 m from users. If people must walk a considerable distance to a latrine, they will defecate in a more convenient location, regardless of the health hazard.

Even when in working order, latrines will not be used unless they are clean. Emergency conditions may dictate at least the initial use of trench latrines. The following standards for pit latrines are desirable.

Facility	Standard
Latrines, family	Not more than four families per latrine without organized, paid maintenance. Latrines should be located at least 6 m from dwellings, 10 m from feeding and health centers, and at least 30 m (and preferably farther) from wells or other drinking-water sources, but no more than 50 m from users.
Trench latrines, shallow (for a few days)	30 cm wide by 1 m to 1.5 m deep by 3.5 m long per 100 people
Trench latrines, deep (for a few months)	70 cm to 100 cm wide by 2 m to 2.75 m deep by 3.75 m long per 100 people

(2) Population Density

Population density will affect the space available for the excreta disposal system and thus the type of system. If latrines are too close to dwellings, there may be insufficient space for individual units. Overcrowding may cause major health hazards and must be considered in site planning. The camp layout should be determined, among other things, by the needs of the most suitable sanitation system, not vice versa. Space must be available for replacement latrines where necessary.

(3) Soil

Soil conditions can vary over a short distance of land, thus requiring a thorough survey of the area. The nature of the soil also may exclude certain options. For example, rocky soil may prevent the digging of pit-type systems. Sandy soil will demand special actions to prevent side-wall collapse of pits. Impervious clay soils may exclude any system dependent on seepage. Account should also be taken of the difference between dry- and wet-season soil conditions. If the ground freezes in winter, the choice of systems may be limited. Where a high

water table exists, even only seasonally, care must be taken to ensure that the water is not contaminated by seepage from the latrines. Excreta must be contained in flood or swampy conditions.

(4) Available Water

The amount of available water will determine whether disposal systems requiring water are a possibility. These systems are generally more expensive than those not requiring water. Because DPs' situations are often characterized by a lack of reliable water sources, the excreta disposal system should not be dependent on water availability. Whatever the system, however, water should be available for anal cleansing and hand washing. The availability of water for hand washing is a critical consideration that should not be overlooked.

(5) Drainage

Because all camps experience rain from time to time, anticipate where surface runoff will flow and how to divert it by cutoff ditches. The possibility of flooding should also be considered and drainage provided if necessary. If floodwater enters latrines, large areas may be contaminated.

(6) Construction Materials

Construction material will be needed to build some types of disposal systems, for example, those with walls and roofs. DPs unaccustomed to latrines generally prefer a large enclosure with no roof. Strong arguments can be made, however, for covering latrines to prevent rainwater from filling the latrine and causing contamination around it or weakening the surroundings. Roofs should provide proper drainage away from the latrine. Special measures will be necessary to manufacture squatting or sitting slabs, water traps, and other equipment for pour-flush systems, if these are not available locally. Where DPs have an established method of covering latrines (e.g., with a wooden lattice), such techniques are generally preferred, even if these methods are more difficult to clean. A number of simple techniques exist for making special plates on site, for example, with reinforced cement and preformed molds. Local materials should be used for the structure as well as for reinforcing the pit

where necessary. Above all, the latrine must be easy to clean, and the surfaces around the drop hole must be washable.

4. Wastewater (Greywater), Garbage, and Dust

a. Wastewater (Greywater)

Excess water from washing, bathing, and food preparation is considered wastewater or greywater. It can be a problem if not drained away. Without good drainage, this water will collect in malodorous, stagnant pools that provide breeding places for insects, especially mosquitoes. Wastewater should generally not be permitted to enter latrines, as this will cause the latrine pit or trench to fill very quickly. If latrine pits or trenches are sufficiently large and the amount of water used for bathing is relatively small, however, DPs should be allowed to use the latrine area for bathing because it provides privacy and drainage. In most circumstances, separate bathing and clothes-washing areas with duck-boards or stones and proper drainage should be constructed.

b. Garbage

Because all communities generate garbage, established routines for the control, storage, collection, and disposal of solid wastes will be required. These needs must be reflected in initial site planning. If uncontrolled, the accumulation of garbage is both unpleasant and unhealthy. The potential for diseases transmission by rodent and insect vectors increases with improper garbage disposal. Free-range chickens, goats, and pigs will help control garbage; dogs will spread it.

The following suggestions for garbage storage, collection, and disposal are of particular concern for high-density camps, where the problem and dangers are greatest.

Storage. To store garbage, containers made of metal or plastic with a minimum capacity of 50 L should be provided. A 200-L oil drum cut in half is often used. Storage containers should have lids and drainage holes in the bottom. A ratio of 1 container per 10 families has proven to be effective.

Containers should be placed throughout the camp so that no dwelling is located more than 15 m from a garbage container.

Collection. The collection of garbage from containers should take place on a regular, daily basis, if possible. Daily collection arrangements must be made to collect medical waste and wastes from feeding centers.

Disposal. Garbage can be disposed of by burying it at designated locations on the site or removing it from the site. Open dumping of garbage on site should be avoided. If garbage has to be dumped, it should be dumped far from the settlement areas. The ashes should be covered with a layer of soil after each burning.

The safe disposal of medical waste requires particular attention. Needles and scalpels are especially dangerous. Medical waste must be tightly controlled. It should be collected, transported, and disposed of separately. Medical waste should always be burned without delay. This disposal should be done in an incinerator to ensure high temperature and complete burning. Designated areas where medical waste and/or ashes are to be handled should be located far from dwellings and fenced to restrict access.

c. *Dust*

Large amounts of dust carried through the air can contaminate food and be harmful to human health by irritating eyes, the respiratory system, and skin. Dust can also harm some types of equipment used on site. The best preventive measure is to stop the destruction of vegetation on the site. Dust control can be achieved by spraying roads with water or oil, especially around health facilities and feeding centers, as well as limiting or banning traffic from certain areas.

5. Insect and Rodent Control

The environment in a DP emergency is conducive to the proliferation of disease vectors, typically insects and rodents that can also destroy or spoil large quantities of food. Flies tend to breed in areas where food or human excreta are present, and mosquitoes thrive around stagnant water. Because the proliferation rate for both is very high (the life cycle from egg to adult can take less than 2 weeks), the control of flies and mosquitoes is critical. Rats are also a problem as they live in areas with plentiful food, garbage, and cover. As a result of overcrowding and inadequate personal hygiene, lice, fleas, mites, ticks, and other arthropods may also cause health problems.

Reducing the numbers of flies, mosquitoes, and rodents quickly in an emergency may be difficult, but physical screens can be used to control the immediate problem. The most effective long-term method of controlling insects and rodents is to make the environment less favorable for the vectors. This task is done by improving personal hygiene, sanitation, drainage, garbage disposal, and food storage and handling practices. Practical measures include removing stagnant wastewater, collecting garbage on a regular basis, using oil in latrines, and providing soap and sufficient water for washing. These measures should be integrated into a regularly inspected program with other health measures.

Vector control methods using insecticides and poisons can be dangerous. Like all methods involving chemicals, instructions for use should be closely followed, and the application supervised and monitored by specialists. All major efforts to control insects and rodents must be closely coordinated with national programs and practices, especially with the national malaria control program. Although several different methods may be used, insect breeding grounds and the dwellings of the DPs may be sprayed. Since insects may already have, and can quickly develop, a resistance to chemicals, a rotation system using different sprays may be necessary. Local knowledge of existing resistance is required. Poison and traps may be used against rats in food storage and handling areas. Particular care must be taken in disposing of dead rats, which may carry plague-bearing fleas. Chemical spraying and rodent poisons can be dangerous to humans.

The body louse, usually found on inner clothing seams, is the only proven vector of louse-borne (epidemic) typhus and epidemic relapsing fever. If a serious increase in body louse infestation occurs, quick action is required by properly trained personnel. This action generally includes dusting individuals' inner clothing and bedding with an insecticide or fumigating clothing. Widespread resistance of lice to some insecticides is a challenge, and expert local advice must be sought. Mass washing of clothing is not recommended as a water temperature of at least 52 degrees Celsius must be maintained to kill the lice.

The following is a listing of vectors and their potential health risks.

Vector	Risk
Flies	Eye infections (particularly among infants and children), diarrheal diseases, onchocerciasis
Mosquitoes	Malaria, filariasis, dengue, yellow fever, encephalitis
Mites	Scabies, scrub typhus
Lice	Epidemic typhus, relapsing fever
Fleas	Plague (from infected rats), endemic typhus
Ticks	Relapsing fever, spotted fever
Rats	Rat bite fever, leptospirosis, salmonellosis

6. Fires

DP camps are often overcrowded, are built of highly combustible shelter materials, and have many individual cooking fires. For these reasons, camps are very vulnerable to major fires. Measures to prevent and control fires must be considered from the start of emergency assistance at DP camps.

a. Prevention

The most basic and effective measure to prevent a major fire is the proper spacing and arrangement of all buildings to provide firebreaks. Other measures include allowing individual fires for cooking only and building fires outdoors only, if possible. If cooking must take place indoors, and especially in wooden or wattle-and-daub buildings, the cooking area should be protected with fire-resistant sheeting if possible. If large-scale cooking takes place indoors (e.g., in a supplementary feeding center), fire-resistant ceilings and walls are mandatory. Fire retardants can be applied to thatched roofs in dwellings. Proper precaution must be taken when storing and using fuels. Highly flammable synthetic materials should be avoided.

b. Control

When fighting a large fire with scarce resources, the first priority is to contain it, rather than put it out. Fires can be controlled in the first few minutes with modest resources, providing quick action is taken. To control fires, an alarm system, firefighting teams, and beaters must be organized in advance and plans prepared. Water is generally not available in sufficient quantities or at adequate pressure for the control

of major fires; however, sand or other loose mineral soil material can be an effective method of control. A new fire-break should be created by taking structures down manually or with a bulldozer if available.

7. Funeral Services

Dead bodies present a negligible health risk in almost all circumstances. If the cause of death is typhus or plague, and the body is infested with infected lice or fleas, appropriate precautions must be taken as the vector organisms are still capable of transmitting disease. Also, as a precaution, the bodies of cholera victims should be washed and treated with an appropriate disinfectant in preparation for funerals and burial or cremation. Large funeral feasts should be discouraged in the case of cholera victims, and individuals preparing bodies for the funeral should not prepare food. Special precautions must also be taken with the bodies of victims of hemorrhagic fever.

Suitable arrangements for handling dead bodies with dignity and respect are required from the start of a DP emergency. The mortality rate after a new DP influx may be higher than under “normal” conditions. Also, bodies must be protected from rodents, animals, and birds. Authorities should be contacted immediately to ensure compliance with national procedures and provide assistance as necessary. The necessary space for burial should also be considered at the site planning stage, particularly in crowded conditions.

Whenever possible, traditional and customary funeral practices should be employed. Bodies should be buried if acceptable to the community. Health considerations provide no justification for cremation; however, if cremation is the culturally preferred funeral procedure it should be facilitated, if practicable. In some instances sufficient fuel may not be available for cremation. Material needs such as cloth for shrouds should be met.

Before burial or cremation, bodies must be identified and, if possible, the cause of death recorded. This process is of particular importance for disease control, registration, and tracing. Local government officials may also insist on the issuance of death certificates. If the whereabouts of relatives are known, the most immediate relation should be notified.

Consideration should also be given to the need to relocate bodies from burial sites after the emergency situation is over and the

DPs are able to return to their homes. This may require further involvement with the local government. A burial location map should be kept from the start of the emergency to aid in locating bodies for removal.

H. Agriculture and Livestock

1. Seed Security

Populations at risk are often vulnerable for as long as they remain dependent on outside interventions for their survival. In rural areas, self-sufficiency is usually dependent on the ability of farmers to produce sufficient food for themselves and their families. For this to occur, farmers must have some measure of seed security, or economic and physical access to sufficient quantities of good quality seed before the planting season. As with food security, the three variables that are central to the attainment of seed security are availability, access, and utilization.

Seed availability refers to the seed supply within the affected district, region, or community. Seed availability is described according to the desired type, quantity, and quality of seed or planting material available, as well as where and when it can be obtained. Availability may refer both to the farmer seed system and to the commercial seed sector. In almost all regions of the world, each year farmers retain seed from their harvests. In addition to saving seed, some farmers purchase all or part of their seed on the market, either to supplement their own supply or to add diversity to their seed selection. Other methods of obtaining seed include seed exchanges, gifts, and loans.

Seed access refers to the ability of farmers to acquire the seed or planting material that is available. In some cases, seed may be readily available on local markets, but subsistence farmers are either unable to purchase the needed seed, or may not be able to physically reach the area where seed can be obtained. In many crisis situations, access will be limited to only a certain portion of the population. As seed prices go up, the purchasing power will be reduced for many people in the community, and they will no longer be able to purchase what they need for the season.

Seed utilization refers to the ability of farmers to make use of seed, once they access it. This implies that farmers have the

tools, the land, the knowledge, and the physical ability to plant seed. In many situations, these factors will not be an issue. Land tenure, however, may play a role, particularly when DPs are trying to farm. In addition, tools may be needed following a major crisis, and training may become important in situations where new planting materials are being introduced.

a. *Evaluating Seed System Interventions*

Interventions used to strengthen seed systems in a country will be determined by the initial needs assessment; if farmers are seed insecure, understanding which of the above variables is responsible for that insecurity is important, because addressing the wrong component may actually cause further problems over the long term. Practitioners of seed interventions must understand the roles that each of these components plays in agricultural recovery following a crisis and must use this understanding to target interventions accordingly.

Before any intervention is implemented in a region, it is important to determine the origins of seed supply, factors affecting seed security, and how these factors can be dealt with in a sustainable fashion. Perhaps the most important part of this assessment is to distinguish between problems of availability and problems of access before designing a program to address the seed issue. In many cases, the crisis will affect both of these components, but in some cases only one will be affected.

Farmer seed systems vary somewhat from place to place, but they are usually resilient and preferred by farmers. Seed availability is often a factor following a long-term drought or a sudden-onset disaster. In these cases, both stored and planted seeds may be destroyed or lost, leaving farmers without seed to plant, and without the ability to obtain new seed through traditional farmer seed systems. In these cases, seed distributions may be an appropriate intervention

In many crisis situations, access will be limited to only a certain portion of the population. As seed prices go up, the purchasing power will be reduced for many people in the community and they will no longer be able to purchase what they need for the season. Interventions should be targeted toward increasing market access for this segment of the community, rather than the community as a whole. Lack of access to seeds should not be confused with lack of availability,

because interventions for lack of access are very different from those for lack of availability. Treating access problems with seed distributions may actually cause more harm than good, because local farmers and traders rely on market sales to maintain their livelihoods.

When availability is determined to be the most significant problem faced by a community, seeds are often distributed to local farmers. In some situations, distribution of hand tools may also be appropriate. Tools should not automatically be included in seed distributions; need for tools must always be assessed separately.

In other cases, utilization may be a serious problem faced by the farming community. Seeds may not be of appropriate quality to produce a good harvest. Access to farming lands may be constrained by conflict or the presence of landmines. In other cases, households may be unable to plant fields due to a lack of labor caused either by national or military service requirements, or by serious illness (e.g., HIV/AIDS, malaria) of the normally able-bodied family members.

2. Livestock

Livestock—including camels, cattle, goats, sheep and fowl—are an important component of agricultural economies. They provide meat, milk, manure, traction, transport, fuel, skins, hides, and other products. When emergencies occur, livestock productivity decreases and animals can be lost. When conditions improve, livestock are important assets in helping people to recover nutritionally and economically. In times of insecurity, when local populations are displaced, livestock can enable families to retain some stability; by taking the animals with them when they move, families maintain some food security.

Livestock systems vary depending on whether they are part of pastoral lifestyles (nomadic or semi-nomadic) or mixed farming systems. In **pastoral systems**, populations derive most of their food and income from livestock. Pastoralists usually live in arid or semi-arid areas or mountainous regions where crop production is difficult, and the availability and distribution of forage varies seasonally, depending on precipitation. Pastoralists cope with this variability by migrating with their herds and using other strategies to maintain productivity. Livestock production is critical to pastoral economies as they have few economically viable alternatives.

Mixed farming systems include both livestock and crops, and are either sedentary or agro-pastoral (livestock spend a portion of the year in distant grazing areas while crops are produced close to home). Livestock and crop production complement each other and provide many advantages over crops alone by reducing risk and increasing productivity. Animals can graze on crop residues that would otherwise be wasted. They provide manure to fertilize the soil and improve the soil structure. Livestock can survive a short, dry spell, ensuring food security when crops fail.

In both pastoral and mixed farming systems, livestock owners adopt practices that promote food security and reduce risk. Some animals may be placed with other families to avoid total loss from disease or disaster. Keeping different species (e.g., cattle, sheep, and goats) reduces the risk of disease and uses grazing resources more efficiently than keeping only one species. Pastoralists with large herds often split their herds into smaller groups, each tended by a different family member, to more rationally use grazing resources and to reduce the risk of loss from theft, disease, or disaster.

In emergency situations, conflicts arise when DPs with livestock compete for reduced forage and water resources, or when moving herds destroy crops. Often, livestock are slaughtered to generate income or stolen by soldiers or other hungry people. Animal mortality from malnutrition increases when fodder is insufficient or inappropriate. When herds mix at watering points, local endemic diseases increase and weakened animals with low resistance succumb. Livestock losses can be enormous.

Livestock losses can reduce income and food security for 5 years or more while flocks and herds are being restocked. If emergencies continue, as in conflict situations, losses may be so severe that recovering herds is not a viable option. People lose their livelihoods completely as animals die or are sold on local markets, and households become increasingly vulnerable. Destitution is becoming more common among livestock owners as livelihoods are lost.

a. *Evaluating Livestock Interventions*

Evaluating options for livestock interventions requires an understanding of the role of livestock in local production systems and an evaluation of the need to preserve the

nutritional and economic benefits of livestock resources. Knowledge about the severity and distribution of the emergency is important to identify target regions. Monitoring the climate and other conditions is helpful because the situation may change rapidly.

Because livestock have a life cycle spanning multiple years, losses during an emergency situation represent disruptions in both present and future income. Thus, interventions must respond to current needs, while simultaneously addressing long-term opportunities to preserve and enhance livestock assets.

Because the health and population of livestock is closely tied to the natural resources in the environment, it is important to recognize that overstocking in a region can exacerbate problems caused by drought or disease. For this reason, it is important to look very carefully at restocking programs, particularly if the environment has not yet recovered from climatic shocks. In many cases, simply keeping a core herd of breeding animals alive will be the first step to a natural recovery once pasturelands begin to improve. Destocking measures should be considered when market access is a problem (e.g., borders or international markets are closed) and animals are dying from lack of fodder or water. Provision of basic animal health care may be one of the most effective means of preventing excessive animal deaths.

Chapter IV

Disaster Assistance Response Team



Figure IV-1. Disaster Assistance Response Team (DART) Organizational Structure

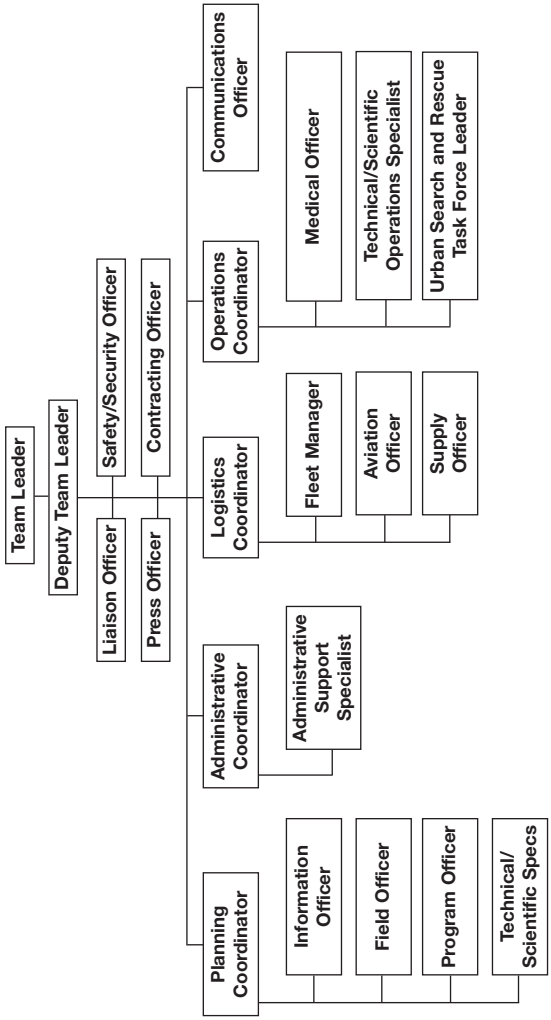

DISASTER ASSISTANCE RESPONSE TEAM

A. Overview

The U.S. Agency for International Development (USAID) Office of U.S. Foreign Disaster Assistance (OFDA) has developed a response capability called the Disaster Assistance Response Team (DART) as a method of providing rapid response assistance to international disasters, as mandated by the Foreign Assistance Act (FAA). A DART is deployed to a disaster-stricken country at the discretion of the OFDA Director and with the concurrence of the U.S. Ambassador or Chief of Mission. The DART consists of specialists trained in a variety of disaster relief skills and assists the USAID Mission or U.S. Embassy with management of the U.S. Government (USG) response to the disaster. The activities of a DART vary depending on the type, size, and complexity of the disaster to which the DART is deployed.

1. Purpose

The DART provides an operational OFDA presence capable of carrying out sustained response activities that may include the following:

- Providing technical assistance to the U.S. Ambassador in formulating and executing an appropriate USG response to the disaster.
- Developing and, on approval, implementing OFDA's response strategy.
- Continuing to assess and report on the disaster situation and recommend followup actions, including suggested funding levels.
- Coordinating the movement and consignment of relief commodities.
- Analyzing existing capacity of the infrastructure and relief agencies to ensure an appropriate, efficient response.
- Reviewing and recommending approval for (or approving, when delegated the authority) relief program proposals.
- Assisting in the coordination of the USG's relief efforts with the affected country, other donors and relief agencies and, when present, other USG entities, including the U.S. military.

- Monitoring and evaluating OFDA-funded relief activities.

DARTs coordinate their activities with the affected country, private voluntary organizations (PVOs), nongovernmental organizations (NGOs), international organizations (IOs), and United Nations (UN) relief agencies and other assisting countries. When U.S. military assets are involved with the disaster response, the DART will work closely with those assets to ensure a coordinated effort by USG resources.

2. Structure

The structure of a DART is dependent on the size, complexity, type, and location of the disaster and the needs of the USAID Mission and U.S. Embassy (USAID/Embassy) and the affected country. The number of individuals assigned to a DART is determined by how many people are required to perform the necessary activities to meet the strategy and objectives. A description of each DART position is provided in this chapter. The DART organizational structure is shown in figure IV-1.

A DART is composed of six functional areas:

1. **Management/Liaison.** Manages overall DART activities, including liaison with the affected country, PVOs/NGOs/IOs, other assisting countries, and U.S. military; the development and implementation of plans to meet strategic objectives; and safety and security.
2. **Operations.** Manages all operational activities carried out by the DART, such as search and rescue activities, technical support to an affected country, medical and health response, and aerial operations coordination. Most active during rapid onset disasters.
3. **Planning.** Collects, evaluates, tracks, and disseminates information about the disaster. Reviews activities and recommends future actions. Develops the DART operational (tactical) plan.
4. **Logistics.** Supports the DART with team supplies, equipment, and services. Orders, receives, distributes, and tracks USG-provided relief supplies.
5. **Administration.** Manages fiscal activities of the DART. Procures goods and services required by the DART. Provides cost accounting of DART activities.

- 6. Communications.** Manages DART communications. Supervises and trains personnel in the equipment and systems. Develops and implements the DART communications plan.

3. DART Activation and Deployment

The decisions regarding a DART's activation and mission are made at a disaster response planning meeting held at OFDA in Washington (OFDA/W). Final approval on deploying a DART rests with the OFDA Director.

The DART is organized and supervised by a Team Leader selected by the OFDA Director. The Team Leader works directly for the OFDA Director or his or her designee. The OFDA Director provides the Team Leader with a scope of work and delegation of authority, if needed, for the DART. These documents outline the DART's objectives, priorities, constraints, funding authorities, and reporting requirements. Based on this information, the Director, in consultation with OFDA's Senior Management Team (SMT), will identify and fill other team positions.

Before departure, the Team Leader will attempt to contact the U.S. Embassy and/or USAID Mission (if present in the affected country) to discuss the situation, review the DART's structure, size, objectives, and capabilities, and identify the areas of support needed by the DART in-country.

On arrival in an affected country, the Team Leader reports to the senior U.S. official to discuss the DART's objectives and capabilities and receive additional instructions and/or authority. While in the affected country, the Team Leader advises and may receive periodic instructions from USAID/Embassy. The Team Leader maintains a direct line of communications with OFDA/W throughout the operation. The primary point of contact for the DART is the OFDA Regional Team, or if activated, the Response Management Team (RMT).

The duration of a DART operation is determined by USAID/Embassy and OFDA/W and is based on the disaster situation, the progress of the DART in meeting its objectives, and the recommendation of the Team Leader.

Figure IV-1 portrays the positions and relationships described in this section. This chapter provides position descriptions and checklists, grouped by DART functional area, that outline the

roles and responsibilities for DART members. These descriptions are also applicable for defining the roles and responsibilities of members of OFDA Assessment Teams.

Additional positions that exist under the Urban Search and Rescue (USAR) Task Force leader are described in the Federal Emergency Management Agency's (FEMA's) *Urban Search and Rescue Response System Field Operations Guide*.

B. DART Setup and Closeout Guidelines

1. Introduction

These guidelines may be used during DART setup to increase the efficiency of DART operations and ease the closeout or transition of the DART to USAID/Embassy or OFDA/W.

The philosophy of setup and closeout should be one of cooperation and collaboration with USAID/Embassy and, therefore, thinking ahead to their needs is critical. This cooperation and collaboration must also include agency partners that may establish a presence as the DART withdraws. Initiating planning for the transition when the DART is first set up will facilitate the eventual transfer to USAID/Embassy and the closing out of the DART.

The goal of a DART closeout should be to effect a seamless transition to the USAID/Embassy or OFDA/W. This transition will assist the succeeding entity in continuing support for the situation in terms of reporting, program management, and situation analysis.

Many tasks identified in this section fall within the area of responsibility of the DART's Administrative Officer; however, all team members are responsible for assisting in the setup and closeout of a DART by setting up and maintaining proper files.

2. Setup

a. Files and Recordkeeping

For security purposes, electronic files, instead of paper files, should be maintained (see the section on electronic storage below). When needed, paper files should be kept as simple as possible. Information Officers set up a simple, clearly documented filing system for cables, correspondence, and e-mail commencing on Day 1 of the operation. Binders for

incoming and outgoing e-mail messages have proven to be successful. The historical file of all e-mail should be stored electronically.

The Administrative Officer establishes a financial tracking system for petty cash, fund cites, personnel files, leases, and procurement files.

The Program Officer establishes grant files for each grant as funding is put in place. Files are also created for rejected proposals and related correspondence.

All DART staff set up in/out boxes for correspondence, taskers, reports, and the like.

In addition to the grant files, maintaining a desktop binder that contains copies of the final grant documents, by UN/PVO/NGO/IO and grant number, has been found to be useful. This process enables DART members to rapidly find documents when having discussions with grantees and have a handy reference when working on situation reports (sitreps), replying to e-mails from Washington, etc.

(1) Sensitive but Unclassified Data

Sensitive but Unclassified (SBU) data is information that requires protection due to the risk and magnitude of loss or harm that could result from inadvertent or deliberate disclosure, alteration, or destruction of the data. People entrusted with SBU information must safeguard it and employ the most stringent access controls available. Examples of SBU data that may be used on a DART are personal information, personnel actions, travel itineraries, procurement information, and cost or program planning information.

SBU information must be processed on unclassified computer systems approved by the designated Information Systems Security Officer (ISSO). Users must not handle SBU information on systems not formally approved for that purpose. E-mail messages or attachments containing SBU information should be sent on a need to know basis. When transmitting SBU information over the Internet, users must use agency ISSO-approved encryption methodologies. SBU information must be secured in a locked room or a locked container. Printed materials and removable media containing SBU information must be

marked “sensitive” or carry a distribution restriction alerting data owners and recipients of the additional protective measures required. SBU data must be destroyed by burning, shredding, or other designated ISSO-approved methods when no longer needed. Sensitive magnetic storage media used on agency systems must be overwritten using approved overwrite procedures or degaussed with a magnet approved by the ISSO for USAID.

(2) Electronic Storage

Save e-mail, memos and strategy pieces, sitreps, and UN/PVO/NGO/IO grant documents in the OFDA eRoom in separate electronic files.

The Information Officer is normally responsible for the electronic storage of sitreps, cables, and e-mail messages and the Program Officer for grants, strategy documents, etc. The Administrative Officer is responsible for all administrative files. The Information, Program, and Administrative Officers should communicate with each other and the DART Communications Officer to coordinate file storage in eRooms.

b. Contact List

A contact list is established by the Information Officer(s). This list should be sorted by organization, name, and function. Noting the date of initial contact may also be useful, especially for long-term DARTs. Periodic review and update of the list is often useful. Obtaining contact information that provides temporary (field) and permanent (headquarters) contact information can be very helpful.

c. Program Management

DARTs operate under an operational plan that is updated periodically by the Team Leader, Planning Coordinator, and OFDA/W, with input from USAID/Embassy. The operational plan identifies the priority areas for OFDA support for relief activities and enables team members to work with UN/PVOs/NGOs/IOs in a focused and professional manner. The plan should be shared with the relief community. Involvement in the development of the plan will also enable USAID/Embassy to see the evolution of the program over time before their inheritance of the operation.

As proposals are reviewed, written comments by team members should be recorded, thereby providing an archive of the discussions that took place regarding each proposal before the proposal reached the final funding stage. This system is also useful if a DART is split and contracting occurs away from the center point of the team; a consolidated comment paper from the team can be forwarded to the Contracting Office for inclusion into the final file and discussion with UN/PVOs/NGOs/IOs. This will ensure that complete historical records are available when the DART leaves.

Any adjustments to grantee programs, even if amendments are not called for, should be recorded in writing and put in the appropriate grant files.

All DART members, even specialists with particular focus areas, should be familiar with the whole program to ensure consistency and continuity throughout the deployment. Mapping of DART-funded program activities is useful in this regard.

Foreign Service Nationals (FSNs) and locally hired U.S. personnel provide continuity as well as geographic and cultural familiarity. Provide newly hired staff with OFDA orientation.

Petty cash funds should be reconciled every 30 to 60 days.

A daily schedule of programmatic review meetings should be posted.

d. Packaging

Save any reusable packaging for equipment or supplies that will be returned during closeout.

e. DART Headquarters

Seek space in a commercial facility, such as a large office building or hotel, rather than sole occupancy of a building or compound. Existing space in the foreign affairs community is preferred. Commercial sites facilitate the immediate implementation of security applications at a minimum cost. Sole occupancy of a building or compound requires several additional security applications that require longer implementation time along with an additional cost. The Safety/Security Officer should inspect potential facilities to ensure they meet agency guidelines.

3. Closeout

a. *The Date*

Difficult as it might be to project, the DART, working with OFDA/W and USAID/Embassy, should determine a target closeout date as far in advance as possible. The message that the DART is leaving must go out early to all concerned groups, organizations, and offices.

When a date is roughly determined, OFDA/W, working with the DART, must define the scope (operationally and programmatically) of the activities that will remain and begin to prepare USAID/Embassy or OFDA/W for the takeover of the program. This entails discussions on staffing, levels of funding available, disposition of equipment and supplies, etc.

b. *Administration*

The Team Leader, with the Administrative Officer, should prepare a checklist for all actions that need to be taken to close the DART. Assign a lead person for each action. Distribute a checklist to each team member and monitor progress toward completion of actions. A master list should be maintained by the Team Leader or Administrative Officer, who will note when actions are completed. Distribution of a task list enables team members to work their part of the closeout into their ongoing DART schedule.

c. *Personnel*

The DART should discuss with OFDA/W the possibility of establishing an OFDA program office to provide programmatic continuity after the DART closes.

Ensuring that USAID/Embassy understands and agrees with the plans for the transfer or separation of FSNs and locally hired staff is critical. OFDA's policy is to try to ensure the transfer of all staff to other USG agencies when possible. All locally hired staff are provided letters of recommendation for their records.

d. *Moving and Transferring Files*

A DART transition may require a physical relocation of files and documents to USAID/Embassy. Before moving:

- Visit the new location and identify the new space for DART files. If an Executive Officer (EXO) has already been assigned, work with him or her on these details.

- Decide what needs to be moved and what is needed to move it.
- Provide a copy of the file list to OFDA/W. If some files are needed back in OFDA/W, they should be removed from the files and put aside for sending to OFDA/W. If USAID/Embassy desires the same files, copies need to be made.

If organizational systems were put in place early, the actual transfer becomes easy. The files are catalogued by subject and grant, and a list can be handed off to USAID/Embassy. Originals can be returned to OFDA/W if required.

The sitreps are transferred to USAID/Embassy, giving USAID/Embassy a format on which to base any continued reporting that may be required.

e. Program Management

The most challenging part of the transition is ensuring that all matters regarding programs and grants are “complete” from the DART field perspective. Following is a list of actions that need to be taken:

- Grantees must be notified as early as possible that a transition is imminent. The DART must explain how the transition will affect their programs. Individual meetings with grantees are recommended.
- A general letter explaining the transition should be sent to all grantee headquarters and field offices at least 2 weeks before the DART’s final day of operation. The letter can be drafted in the field but should be cleared with OFDA/W and the USAID/W Contracts Office. The letter should outline the administrative changes and thank the grantees for their collaboration with the DART.
- If a DART is shifting from field contracting to USAID/W contracting, for each grant, each grantee must receive an Amendment Letter noting the change in the Action Officer and any other blanket changes that are being caused by the DART’s move.
- Depending on where the grant funding has been executed, it will be important for the DART to work out arrangements for the handling of DART grants with USAID/Embassy. Grants should be transferred either back to Washington

or to the USAID Mission/Embassy, as appropriate, including those grants executed by the DART in the field.

f. *Public Relations*

Send letters to key colleagues (e.g., the Special Representative of the UN Secretary-General, Force Commander, International Committee of the Red Cross [ICRC], local officials) explaining the DART closeout and transition and expressing DART's appreciation for their collaboration.

Send a cable announcing the DART transition and thanking missions and embassies in the region for their support.

g. *OFDA Funds*

Administrative approval for payment of bills can be transferred to the OFDA Program Officer or an approved USG official, e.g., a USAID EXO. Unliquidated funds should be deobligated as soon as possible. Petty cash must be cleared before the DART's departure. If petty cash funds were provided in the field, they must be accounted for in the field. If petty cash funds were provided in Washington, they must be accounted for in Washington. To clear the fund, gather all receipts together. A ledger should have been maintained showing the drawdown of the funds. This information should be returned to the point where the funds were issued. Any residual funds will be returned by the controlling mission to OFDA/W.

h. *Transfer of Property*

The DART Administrative Officer must work with the Property Disposal Officer to dispose of any OFDA property during the closeout in coordination with the appropriate staffs (e.g., Communications, Logistics). The disposition should include an agreement on how to handle the property—transfer it, leave it in place for use for a set period of time, or leave it as prepositioned equipment—and whether OFDA will be expected to provide support for the equipment and the nature and extent of the support.

The DART Administrative Officer will base his or her decision on the most appropriate recipient of OFDA property according to the following choices, listed from the most optimal to least optimal:

1. OFDA-funded NGOs and PVOs responding to the disaster.
2. USG-funded NGOs and PVOs responding to the disaster.

3. Other non-USG-funded organizations with a clear humanitarian mandate consistent with the purposes of the International Disaster and Famine Assistance account, including the appropriate UN agencies and IOs, e.g., ICRC, International Organization for Migration.
4. The USAID Mission in-country.
5. Other OFDA-funded programs to the extent that transporting property is cost effective.
6. Public auction with funds credited to OFDA, after requesting Property Disposal Officer assistance.

When equipment is provided to a non-USG entity, it represents an “in-kind” grant, and appropriate documentation is prepared and signed by the U.S. Embassy or USAID Mission and the recipient of the equipment. The “in-kind” grant must be signed on behalf of the USG by a person with the requisite signing authority. The estimated value of the “in-kind” equipment is considered to be the amount of the grant.

i. Communications

Equipment provided by OFDA/W Communications should be returned to OFDA/W Communications. Equipment procured in the field can be disposed of according to local regulation.

j. Closeout Memo

The Team Leader, during the final closeout with USAID/Embassy, may want to develop a Closeout Memo that defines all follow-on relationships between OFDA and USAID/Embassy. The memo can address issues such as outstanding financial obligations and the disposition of property and locally hired staff.

C. Working With the Response Management Team

1. Overview

To provide the necessary support to a DART, the OFDA Director may decide to activate an OFDA/W RMT. The OFDA Director, through the RMT, coordinates the USG response to a disaster from OFDA/W. The RMT serves as the primary liaison between field disaster response and OFDA/W. When the RMT is activated and in place, responsibility for decisionmaking, coordination,

and primary point of contact for DART(s) or other resources deployed in the field moves from the Regional Team to the RMT until these responsibilities are returned to the OFDA Director.

2. Purpose

The chief purpose of the RMT is to represent USAID, oversee Washington-based support, provide interagency coordination of the relief activities, and support DART field operations. On occasion, more than one deployed DART may be supported by the RMT.

During a disaster response, the RMT coordinates the USAID response for the USAID Administrator and serves in a leadership role to coordinate the work of the various cooperating agencies. The RMT assesses USAID and cooperating agency information needs, develops timely and accurate information on the general disaster situation and USG response, and distributes this information appropriately. The RMT supports the DART(s) through OFDA divisions and other USG coordination including providing staffing and logistical support and acquiring and transporting relief supplies. The RMT coordinates the OFDA/W review and approval of funding proposals of relief activities, tracks OFDA obligations, and reports on other USG contributions. When U.S. military assets are involved with the disaster response, the RMT works closely with the appropriate Department of Defense (DOD) components to ensure a coordinated USG effort.

3. Activation

If the scope, complexity, or volume of the response to a disaster exceeds the capabilities of the OFDA Regional Team, the OFDA Director may activate an RMT under the leadership of a Response Manager. An RMT will usually be activated when a DART deployment is anticipated or occurring.

An RMT could be assigned in the following conditions, including but not limited to:

- High level of political and media interest.
- Multiple agency interest or involvement.
- Rapidly increasing support needs due to rapid-onset-type disasters such as flood, hurricane, or earthquake.
- Significant technological event or accident, including chemical, nuclear, biological, or radiological event.

- Major displacement of civilian populations due to civil unrest or war.
- Multiple disasters.
- Additional support needed for long-term response requirements.

During initial stages of RMT activation, the Response Manager will communicate with the Regional Coordinator and Team Leader(s) to discuss the situation and identify the areas of support needed from the RMT. The Response Manager maintains a direct line of communication with DART(s) throughout the operation and is the lead point of contact between the DART(s) and OFDA.

4. Demobilization

When the complexity and/or workload associated with the relief operation is reduced to a certain level, the OFDA Director, in consultation with the Response Manager, Team Leader, and Regional Coordinator, may decide to move response management back to the Regional Team. Conditions where this would occur could include, among others:

- Demobilization of DART personnel.
- Maintenance-level DART operations.

At that time, the RMT will orchestrate an orderly transition of duties and responsibilities back to the Regional Team. In some cases, developing an interim staffing arrangement, in which some RMT positions are retained to supplement Regional Team staffing to handle the response workload, may be appropriate. A detailed Demobilization Plan will outline the transition steps, staffing, and timelines.

5. Structure

The structure and composition of the RMT is dependent on the size, complexity, type, and location of the disaster.

The OFDA/W RMT performs in five functional areas:

1. **Management** manages overall RMT activities—including liaison with deployed DART(s), other offices within USAID, and cooperating agencies—and serves as point of contact with the media.
2. **Planning** manages the response strategy and planning processes, is responsible for the daily preparation of informa-

tion products, and serves as the coordinator for the program grant funding and management process.

3. **Logistics** manages the sourcing and transportation of supplies and materiel to the disaster site.
4. **Administration** manages and provides support to RMT administrative/contract activities.
5. **Communications and Records** manages communications, ensuring that proper formats, distribution, filing, and documentation procedures are followed according to standards established in the Communications and Records Procedures.

The number of individuals assigned to the RMT is determined by the skills and qualifications needed to perform the necessary activities to meet the strategy and objectives. The organizational structure is designed to expand or contract depending on the complexity and operational requirements.

D. Working With the Media

1. General

The Team Leader sets the guidelines for relations with the media covering the disaster. If a Press Officer is a member of the DART, he or she is the contact point with the media. If not, the Team Leader takes on the direct media relations function. The following guidance is mainly for Press Officers. This guidance is helpful, however, to any member of the team who may become involved with responding to media requests.

2. Ensure Close Coordination

- See Press Officer responsibilities in section F, part 3, of this chapter.

3. Develop a Strategy and Plan

- To ensure good media relations, be proactive, not just responsive.
- Working with the USAID Bureau for Legislative and Public Affairs (LPA) and in close coordination with the Embassy Public Affairs Officer (PAO), develop a media strategy and plan that includes overall objectives, goals for visibility, primary and secondary audiences, target media, key messages, types and frequency of communications, and distribution channels.

4. Know Your Story

- Develop three core messages *before* speaking to the media. Think about the desired headline you want to see in the press the next day.
- Think about creative ways to “package” the message, not just answer media inquiries about humanitarian commodities delivered to the affected population.
- Include facts and figures and good examples and stories about improving the lives of real people. Effective messages are both emotional and rational.
- Provide visuals. DART members in action help to tell the story. Look for good backdrops for interviews and opportunities for photographers and camerapersons to capture powerful images.
- Find local people willing to share positive experiences about U.S. assistance. Beneficiaries can be great spokespeople.

5. Rules for Dealing With Reporters

- Be prepared:
 - Do your homework. Research the reporter and other stories that he or she has written. Try to determine his or her angle or frame of reference before going into the interview.
 - Develop talking points before the interview so that you can repeat your main messages and get the key points across.
- Set the ground rules beforehand:
 - Agree to the length and format of the interview.
 - Agree on if the comments will be on the record, on background, on deep background, or off the record. Do this up front because you can't agree to these terms after the interview has already occurred.
- Never pick a fight with the news media:
 - They air or print every day, and you don't.
- There are no secrets:
 - Assume that what you say and do will get on the air or the printed page.

- Although you can say things “off the record,” this doesn’t mean the media won’t print it and give you attribution.
- Don’t assume anything:
 - Reporters may not be well-informed or technically proficient about your profession.
 - Explain terms to ensure they are understood.
- Keep it simple:
 - Simplify and summarize your major points.
 - Write facts and data down to hand out.
 - Use plain English. Talk in a relaxed style that is aimed at laypersons, not subject experts.
 - Avoid acronyms.
 - Remember that the audience is the general public.
- Give reporters a good story to write, or they may find one you don’t like and write it:
 - Listen for trends in the questions. Is the reporter asking leading questions? Are there obvious misconceptions? Offer to clarify or redirect.
 - Understand that the media seeks truth but will settle for balance. Ask who else is being interviewed. An opposing view is sure to be included.
 - If a critical or controversial story is going to be written anyway, the USG’s point of view should be in the story.
- Treat reporters professionally:
 - Treat them with respect.
 - Always answer their calls immediately. Carry a cell phone if possible.
 - Create relationships. Many journalists cover disasters as part of their “beat.”
- Don’t lie:
 - Make sure your information is accurate.
 - Remember, your comments don’t have to be all encompassing. You don’t have to tell a reporter the DART’s perspective on everything.
 - If you don’t know something, say so. Take the question, get the answer, and get back to the reporter.

- Never speculate.
- Never speak out of your area of specialization, which is humanitarian aid. Don't answer questions about USG relations with the affected country or another nation, or what security forces should be doing. Let the proper agency, such as the State Department or DOD, answer those questions.
- Before you do an interview, decide what you can and can't discuss—and stick to it.
- Choose your words carefully and well. They will likely be reported as you say them.
- Be repetitive. Repetition is the essence of retention. The public will remember what they see, hear, and read repeatedly in the media.
- Use objective and authoritative sources of information to back up your statements to reporters, if you can.
- Try to anticipate questions. If you can't answer or you don't know the answer, get back to the reporter after you are asked such questions so you can give a considered response.
- Always correct any wrong information *immediately*.

E. General Checklist for All DART Members

1. Predeparture

- Establish contact with your supervisor and receive a briefing on:
 - The latest situation status of the disaster.
 - DART objectives and priorities.
 - Scope of your assignment in the DART.
 - Organizational structure of the DART.
 - Visa and medical requirements.
 - Special equipment needs.
 - Functional staffing needs.
 - Travel arrangements and coordination with OFDA.
 - Security situation and safety precautions.
- Check on availability of local maps.
- Inform supervisor of in-country support needs.

- Contact unit personnel, brief them, and ensure their preparedness.
- Ensure that equipment is acquired, prepared, and ready for shipment.
- Notify Embassy through cable of the type, amount, and serial numbers of all equipment being taken by the team into the affected country.
- Review Individual Team Member and Team Support Checklists in Chapter I, “General Responsibilities and Information.”
- Leave family names and contact numbers with OFDA.
- Leave family with power of attorney.

2. In Transit

- Review briefing materials from supervisor, including:
 - USAID/Embassy disaster relief plan.
 - State Department background notes.
 - Disaster history.
 - Lessons learned from previous responses.
 - In-country contact list.
 - Maps.

3. In-Country

a. Immediate Actions

- Discuss the following with your DART supervisor:
 - Response strategy.
 - Known cultural sensitivities of affected country.
 - Role of USAID/Embassy and affected country officials.
 - Initial work assignment.
 - Daily shift and briefing procedures, including time schedules.
 - Ordering and procurement procedures.
 - Property accountability.
 - Types of documentation required.
 - Reporting requirements by individual and team.

- Media contact philosophy and procedures.
- Policy on communicating with family members.
- Perform an initial evaluation of the situation from your functional point of view.
- Discuss the situation with the USAID/Embassy, local officials, other assisting country teams, and UN/PVOs/NGOs/IOs as appropriate.
- Assess the affected country's and other response organizations' abilities to manage the situation.
- Determine additional requirements (personnel, equipment, facilities, logistical support) and make recommendations to the supervisor.
- Provide inputs to your supervisor for the operational planning.
- Implement the operational plan.

b. Ongoing Actions

- Contribute to the team's operational planning process.
- Provide leadership and technical guidance and resolve any coordination and personnel problems within your function.
- Inform your supervisor and others of the current situation as needed, including:
 - Work accomplishments.
 - Inability to operate as planned.
 - Potential political problems.
 - Internal and external coordination problems.
 - Shortage or surplus of resources.
 - Accidents involving assigned resources.
 - Safety or security concerns.
- Coordinate continuously as directed with the affected country's local officials, USAID/Embassy, other response teams, and UN/PVOs/NGOs/IOs.
- Record significant actions and events in the unit log each day, and submit it to your supervisor.
- Constantly critique the operation of the function, and recommend changes to your supervisor.

- Evaluate the ability of assigned resources to meet demands.
- Review the need for replacement of supplies, equipment, and personnel. Request more of each as needed.
- Identify evidence of public health problems.
- Constantly monitor activities to ensure they are carried out safely.
- Monitor team personnel for signs of critical-incident stress syndrome.

4. Demobilization

- Review staffing and resource requirements, and recommend the release of excess personnel and equipment.
- Coordinate demobilization with your supervisor and/or planning function.
- Close out with the affected country and other cooperating organizations as necessary.
- Close out with USAID/Embassy as necessary.
- Account for all your equipment and supplies.
- Prepare nonexpendable items for return shipment, including completion of customs documents.
- Evaluate your function's performance, including:
 - Lessons learned.
 - Individual performance of unit personnel.
 - Concerns.
 - Future training needs.
 - Recommended changes.
- Submit all reports, evaluations, unit logs, and time records to your supervisor or the planning function.
- Review the General Checklist for All DART Members (this section) and your position specific checklist (see sections F – K), and make recommendations.
- Prepare for and participate in debriefings as requested.
- Clean up your work area.

F. Management/Liaison Functional Area

The Management/Liaison functional area includes the following positions:

- Team Leader.
- Deputy Team Leader.
- Press Officer.
- Safety/Security Officer.
- Liaison Officer.
- Contracting Officer.

The following sections outline the specific responsibilities for each position.

1. Team Leader

The Team Leader is responsible for managing overall DART activities; is the liaison with the affected country government, other USG agencies, UN/PVOs/NGOs/IOs, and other assisting countries; ensures the development and implementation of strategic decisions; reports to the senior U.S. official in the affected country; and receives a scope of work and any funding delegation of authority from the OFDA Director. The Team Leader reports to the OFDA Director or his or her designee.

Following are specific responsibilities of the Team Leader.

a. *Predeparture*

- In conjunction with the SMT and the OFDA/W Operations Division Field Support Unit, identify and select DART positions as needed. The OFDA Director has the final authority for DART member selection.
- Inform selected team members of deployment, mission, expected duration, and team organization.
- Obtain a copy of the DART scope of work with any funding delegation of authority, if appropriate.
- Receive general briefing from OFDA/W staff. In addition to the General Checklist for All DART Members in section E, discuss:
 - Political sensitivities relating to the affected country.
 - Gender issues relating to the affected country.

- Security situation and any potential evacuation strategy.
- Types of resources that are available or that can be requested, resource ordering process, and use of stockpile items.
- Affected country's disaster response capability.
- Status of affected country's response to the disaster.
- Other international response to the disaster (countries and organizations).
- UN/PVOs/NGOs/IOs with programs in the affected country.
- Points of contact at USAID/Embassy.
- Points of contact in the affected country's government.
- Policies/procedures related to DART members.
- Staff rotation and stress management plans.
- Exit strategy.
- Coordination of international response through the UN and points of contact and/or other coordination activities among PVOs/NGOs/IOs and the donor community.
- Media guidance and strategy.
- Fiscal authorities and restrictions.
- Deployment timeframe.
- Develop an initial operational plan incorporating available information on the disaster, mission objectives, and initial DART activities. Include:
 - Situation.
 - Team mission.
 - Team organization.
 - In-country resources and organizations.
 - Logistics.
 - Communications.
 - Safety and security.
 - Media strategy.
- Brief OFDA staff and discuss staffing requirements, in-country support requests, and special travel needs.

- Ensure adequate and appropriate training of team members. Have a plan for conducting refresher training.
- Ensure the acquisition and preparation of team support items.
- Ensure that adequate communications equipment is ordered for all functions.
- Ensure an adequate stock of DART field wear/clothing is available for team members.
- Obtain copies of contracts for nondirect-hire DART members.
- Ensure that the DART has the capability to fiscally support itself on arrival in the affected country.
- With Planning Coordinator and OFDA staff, conduct initial DART briefing.
- Designate the planning function to take the lead on acquiring all necessary maps.
- Cover all items in the In Transit section of the General Checklist for All DART Members in section E.

b. In-Country

(1) Immediate Actions

- Notify OFDA/W of the DART's arrival, initial information obtained, preliminary operational plan, and initial actions taken by the DART.
- Report immediately to the senior USAID/Embassy official, present DART capabilities and objectives, and receive briefing. Discuss safety and security, disaster, and international response activity update; USAID/Embassy lines of authority and reporting requirements; support capability of USAID/Embassy for personnel, equipment, storage, workspace, and transportation; and in-country procedures related to local laws or customs that might affect DART operations.
- Meet with U.S. Embassy Regional Security Officer (RSO) or other security personnel, and coordinate team security briefing and DART operational plan.
- With the Planning Coordinator, refine the team operational plan based on immediate evaluations from all functions and briefings from USAID/Embassy.

- Locate a DART headquarters and get set up (see the DART Setup and Closeout Guidelines earlier in this chapter). It should be accessible to USAID, the U.S. Embassy, and the disaster site. Ensure that adequate safety and security measures are in place to protect DART members.
- With the Administrative Officer, meet with key USAID/Embassy officials, including the USAID controller and/or Embassy budget and fiscal officer, to discuss OFDA procurement procedures and fiscal requirements of the DART (local currency).
- If the initial operational plan requires an immediate tactical response or logistical support, ensure the deployment of required personnel and equipment.
- Identify potential locations for warehousing, airport staging, storage, and administrative operations.
- Develop a staff work schedule that provides for fair distribution and rest time.
- Determine daily and weekly work schedule of affected country.
- Oversee the development of situation reporting, operational planning, resource tracking, documentation, and commodity consignment systems.
- Establish contact with other assisting country teams and UN/PVOs/NGOs/IOs.
- Establish contact with the appropriate affected country's ministries as necessary.
- Discuss potential safety issues and future technological problems with the Safety/Security Officer and Technical/Scientific Operations Specialists.
- Discuss and plan appropriate media activities with the Press Officer.
- Determine additional requirements (personnel, equipment, facilities, logistical support). Identify these to USAID/Embassy and OFDA, and make recommendations.

(2) Ongoing Actions

- With the Planning Coordinator, conduct regular planning briefing and debriefing sessions. Ensure regular

attendance and contributions from all DART members into the team's operational planning process. Review ground rules on press contact and contact with USAID/Embassy, the affected country, and other organizations.

- Maintain close communication with OFDA/W. Inform OFDA/W of the current situation, work progress, problems, planned actions, effectiveness of response, condition, and performance of DART members.
- Review and clear sitreps and DART cables.
- Conduct daily review and discussion on programmatic, safety, and security issues with DART program personnel.
- Maintain close communication with senior USAID/Embassy officials. Ask them to explain the mission of the DART to the Embassy Country Team.
- Coordinate continuously with affected country representatives, other assisting country teams, and UN/PVOs/NGOs/IOs. Promote coordination among UN/PVOs/NGOs/IOs and donor communities.
- Conduct a daily, or as needed, critique of all functions for effectiveness, validity of priorities, soundness of objectives, and ability of DART members to carry out assignments. Institute changes as necessary.
- Constantly foster open communications with USAID/Embassy to ensure continued support of the DART and that the DART is meeting their needs. Keep them informed of DART activities and progress.
- Where appropriate, attend Embassy Country Team meetings.
- Ensure that all DART members maintain daily unit logs as required.

c. Demobilization

- Oversee the development of the DART demobilization plan. Review the plan with USAID/Embassy and OFDA/W.
- Review "DART Setup and Closeout Guidelines" earlier in this chapter.

- Review all documentation, such as videotapes, pictures, logs, sitreps, and cables.
- Identify additional final disaster report requirements, and assign responsibilities as required.
- Notify OFDA/W of the final demobilization arrangements.
- Participate in writing and reviewing the final disaster report.
- Ensure that all fiscal agreements are concluded.
- Ensure that requested documentation and final disaster report are distributed to the local USAID/Embassy before departure.
- Debrief the senior USAID/Embassy officials.
- Submit the final disaster report to OFDA/W.
- Prepare and conduct a debriefing with OFDA staff in Washington.
- Assist with the preparation and participate in the DART After Action Workshop.

2. Deputy Team Leader

The Deputy Team Leader assists the Team Leader in managing overall DART activities and is responsible for managing the internal operations of the DART. The Deputy Team Leader position is filled only when the Team Leader, with concurrence from OFDA/W, can demonstrate the need for the position. Factors for consideration when deploying a Deputy Team Leader include, but are not limited to, operational mission, size of the DART, complexity of the operational environment, and the requirement to operate from several locations simultaneously.

The Deputy Team Leader serves as the second-in-charge and fulfills the role and authorities of the Team Leader when required and authorized. The Deputy Team Leader ensures that all sections of the DART organization are performing efficiently and have the necessary resources to function, assists the Team Leader in reporting to the senior U.S. official in the affected country, and reports to and receives a scope of work with specific duties from the Team Leader. The Deputy Team Leader's focus is directed more at the internal operations of the DART, allowing the Team Leader to concentrate efforts externally.

Following are specific responsibilities of the Deputy Team Leader.

a. Predeparture

- Assist Team Leader in drafting initial DART operational plan.
- Determine the division of responsibilities between the Team Leader and Deputy Team Leader.
- In conjunction with the Team Leader and the SMT, identify and select DART positions as needed.
- With Team Leader, receive general briefing from OFDA/W staff. See Team Leader Predeparture checklist for briefing agenda.
- Brief OFDA staff and discuss staffing requirements, administrative and logistics requirements, in-country support requests, and special travel needs.
- Coordinate with Administrative Officer for initial lodging options and staging support in the affected country.
- Ensure the acquisition and preparation of team support items.
- Ensure that adequate communications equipment is ordered for all functions.
- With Team Leader, Planning Coordinator, and OFDA staff, conduct initial DART briefing.
- Serve as DART advance party, if required, to facilitate immediate DART operational capability.
- Assist Team Leader in other preparations as required.

b. In-Country

(1) Immediate Actions

- With the Administrative Officer, ensure that, at a minimum, the following initial support is in place:
 - Airport pickup and arrival support.
 - Lodging.
 - Transportation.
 - Other requirements as identified.
- With the Team Leader, report immediately to the senior USAID/Embassy official, present DART capabilities and objectives, and receive briefing. Discuss security,

disaster, and international response activity update; USAID/Embassy lines of authority and reporting requirements; support capability of USAID/Embassy for personnel, equipment, storage, workspace, and transportation; and in-country procedures related to local laws or customs that might affect DART operations.

- With the Team Leader and Planning Coordinator, refine the initial team operational plan based on immediate evaluations from all functions and a briefing from USAID/Embassy.
- Locate a DART headquarters and get set up (see also “DART Setup and Closeout Guidelines” earlier in this chapter). Headquarters should be accessible to USAID, the U.S. Embassy, and the disaster site.
- With Administrative Officer, meet with key USAID/Embassy officials, including USAID controller and/or Embassy budget and fiscal officer, to discuss OFDA procurement procedures and fiscal requirements of the DART (local currency).
- If the initial operational plan requires an immediate tactical response or logistical support, ensure the deployment of required personnel and equipment.
- Identify potential locations for warehousing, airport staging, storage, and administrative operations.
- Develop a staff work schedule.
- Oversee the development of situation reporting, operational planning, resource tracking, documentation, and commodity consignment systems.
- Discuss potential safety issues and future technological problems with the Safety/Security Officer and Technical/Scientific Operations Specialists.
- Determine additional requirements (personnel, equipment, facilities, logistical support). Identify these to USAID/Embassy and OFDA, and make recommendations.

(2) Ongoing Actions

- Organize and facilitate regular planning, briefing, and debriefing sessions.

- With the Team Leader, maintain close communication with OFDA/W. Inform OFDA/W of the current situation, work progress, problems, planned actions, effectiveness of response, condition, and performance of DART members.
- Review and clear sitreps and DART cables before the Team Leader's final clearance. Clear sitreps and cables in the Team Leader's absence to facilitate rapid transmission of information.
- Assist in the coordination with affected country representatives, other assisting country teams, and UN/PVOs/NGOs/IOs. Promote coordination among UN/PVOs/NGOs/IOs and donor communities.
- Maintain supervision of administrative, logistics, and communications requirements.
- Supervise locally hired staff as required.
- Conduct a daily, or as needed, critique of all functions for effectiveness, validity of priorities, soundness of objectives, and ability of DART members to carry out assignments. Institute changes as necessary.
- Conduct daily review and discussion on programmatic issues with DART program personnel.
- Constantly foster open communications with USAID/Embassy to ensure continued support of the DART and that the DART is meeting their needs. Keep them informed of DART activities and progress.
- Assist Team Leader in other responsibilities as required.

c. Demobilization

- Oversee the development of the DART demobilization plan. Review the plan with USAID/Embassy and OFDA/W.
- Notify DART members of the final demobilization arrangements. Supervise execution of demobilization tasks.
- Review "DART Setup and Closeout Guidelines" earlier in this chapter.
- Participate in writing and reviewing the final disaster report.
- Ensure that all fiscal agreements are concluded.
- Ensure that requested documentation and final disaster report are distributed to the local USAID/Embassy before departure.

- Supervise finalization of administration, logistics, and communications support before departure. Ensure that a transition plan is established and agreed on for all outstanding issues.
- Assist with preparation and participate in the debriefing with OFDA/W.
- Assist with the preparation of and participate in the DART After Action Workshop.

3. Press Officer

The Press Officer manages DART media activities. The Press Officer reports directly to the Team Leader. The DART is part of the USG and should not operate or communicate in a vacuum. The Press Officer must ensure close coordination throughout the disaster response.

a. Predeparture

- Contact the Team Leader and receive a general briefing.
- Meet with LPA before departure to ensure close coordination in managing the media. LPA can help “pitch” stories to editors and producers in the United States while the Press Officer works with reporters on the ground.
- In addition to the General Checklist for All DART Members in section E:
 - Discuss the media philosophy for this disaster, including the level and type of coverage desired, press release guidelines, and press interview guidelines.
 - Arrange for meeting in-country Press Officer support needs (e.g., cable to USAID/Embassy).
 - Obtain information on USG response activities to date, including commodities delivered, en route, and requested from the OFDA Logistics Officer.
 - Obtain information on response actions of other assisting countries and PVOs/NGOs/IOs.
 - Obtain all press releases pertaining to the disaster.
 - Obtain information on media organizations currently covering the disaster.
 - Coordinate the acquisition and shipping of press function equipment and supplies. Specify weight,

cubes, and number of pieces, and arrange for special handling requirements.

- Organize press coverage at the DART departure site.
- Draft, approve, and coordinate press guidance and daily messages pertaining to the disaster.

b. In-Country

(1) Immediate Actions

- Perform an immediate initial evaluation of the media situation.
- Meet with the PAO at the Embassy, as well as anyone handling press on the USAID Mission staff, to discuss media strategies. Embassy PAOs often speak the local language and have good contacts with local media. Topics for initial discussions with USAID/Embassy staff should include:
 - Current and planned media activities.
 - Disaster effects on population and property.
 - Media management policy (picture taking, filming).
 - Current press organizations in operation.
 - Affected country's media sensitivities.
 - Support facilities available for briefings.
 - Availability of local equipment such as computers, typewriters, copy machines, fax, Internet, microphones, etc.
- Introduce the Team Leader to the PAO to ensure that everyone at USAID/Embassy understands that the Team Leader is an official spokesperson for the specific U.S. assistance being provided.
- Discuss current activities with local officials, other assisting country teams, and UN/PVOs/NGOs/IOs. Reporters will go to multiple sources for information; it's best when all relief organizations communicate the same message and quote the same statistics.
- Develop and distribute DART media message and talking points to maintain consistency of message.
- Obtain copies of any new press releases pertaining to the disaster.

- Obtain a list of international and local media currently covering the disaster.
- Obtain and review the USAID/Embassy disaster relief plan and emergency action plan.
- With the Information Officer and Planning Coordinator, establish procedures for press visits to DART headquarters and the disaster site, as well as regulations for press access to visual displays, maps, sitreps, and resource status information as circumstances permit.
- With the Operations Coordinator, discuss press visits to worksites.
- Evaluate the need for additional personnel and resources to meet press function needs.

(2) Ongoing Actions

- Ensure balanced coverage of team activities.
- Keep the Team Leader informed of all press activities in advance.
- Ensure that proper safety practices are observed during worksite visits.
- Keep DART members informed of U.S. and international news coverage.
- Keep the LPA informed.
- Coordinate continuously with local officials, USAID/Embassy, other assisting country teams, and UN/PVOs/NGOs/IOs.
- Assist the USAID/Embassy in arranging and conducting VIP visits.

c. Demobilization

- Give a technical debriefing to the LPA.

4. Safety/Security Officer

The Safety/Security Officer identifies hazards and risks to DART personnel and oversees adherence to safety and security practices, standards, and procedures. The Safety/Security Officer reports directly to the Team Leader. Specific responsibilities of the Safety/Security Officer are as follows.

a. Predeparture

- Contact the Team Leader and receive a general briefing. In addition to the General Checklist for All DART Members in section E:
 - Discuss safety/security concerns at the disaster site and in any areas where team members may be living and working.
 - Meet with key team members to discuss safety and security issues and procedures.
 - Coordinate the acquisition, preparation, and shipment of office and field supplies and any specialized supplies or equipment to meet safety/ security requirements.

b. In-Country

(1) Immediate Actions

- Perform an immediate initial evaluation of the safety/security situation. Discuss conditions, security, hazards, and needs with local officials, USAID/Embassy (RSO), other assisting country teams, and UN/PVOs/NGOs/IOs. Determine the best use of the safety/security function.
- Perform a thorough evaluation of operational areas. Identify, mark, and document potential hazards, unsafe situations, and security risks. Notify DART members in the area immediately.
- Complete a Safety/Security Plan and brief the entire team on current conditions, potential hazards, and security issues. Share the plan with the USAID/Embassy. Include in the Safety/Security Plan:
 - General safety and security standards and procedures.
 - Medical emergency and evacuation plan.
 - Travel plan procedures.
 - Security evacuation plan.
 - Communications protocols.
 - Serious incident notification procedures.
- Ensure that all team members are briefed on safety and security standards and practices and that all team members observe these standards and procedures.

- Investigate all DART accidents/injuries. Inform the Team Leader of your findings. Make recommendations and take remedial actions as appropriate. Document and file findings, recommendations, and remedial actions.
- Evaluate the need for additional safety and security personnel and resources to meet response objectives.

(2) Ongoing Actions

- Continuously monitor DART operations for adherence to safety and security practices, standards, and procedures.
- Continuously monitor DART members for signs or symptoms of critical-incident stress syndrome. Recommend rest, stress debriefing, or demobilization as required.
- Continually evaluate the situation and provide Safety/Security Plan updates to the planning function for inclusion in the operational plan. The plan can include reviews and updates to issues, such as air operations, vehicle safety, hazard maps, hazardous materials (hazmat) locations, safe working practices at worksites, personnel and visitor safety (media), reporting of hazards and security issues, plan component updates, reporting of accidents, accident investigation, and scheduling safety/security meetings.

c. Demobilization

See section E, General Checklist for ALL DART Members, in this chapter.

5. Liaison Officer

The Liaison Officer coordinates the DART liaison function; serves as the point of contact with the affected country, USAID/Embassy, U.S. military, other assisting country teams, and UN/PVOs/NGOs/IOs; and identifies the political and operational concerns of these groups. The Liaison Officer reports directly to the Team Leader. Depending on the scope and complexity of DART activities, more than one Liaison Officer may be needed. Specific responsibilities of the Liaison Officer(s) are as follows.

a. Predeparture

- Contact the Team Leader, and receive a general briefing. In addition to the General Checklist for All DART Members in section E, discuss:
 - Liaison concerns and needs at the disaster.
 - Roles and authority of the Liaison Officer.
 - Relationships among major respondents participating in the disaster relief activities.
 - Safety and security concerns.

b. In-Country

(1) Immediate Actions

- Perform an immediate initial evaluation of the coordination situation.
- Identify your role and authority as the DART point of contact to USAID/Embassy, affected country officials, U.S. military, other assisting country teams, and UN/PVOs/NGOs/IOs. Discuss with these groups disaster needs, coordination issues, and any concerns they have with DART activities.
- Obtain the necessary credentials for identification and appropriate security clearances needed to be better able to interface with the groups with which you will be coordinating.
- Establish the points of contact with the above groups, including communications links and locations.

(2) Ongoing Actions

- Respond to requests from DART personnel for interorganizational contacts.
- Monitor disaster operations to identify current or potential interorganizational problems.
- Remain visible and available to affected country officials, U.S. military, other assisting countries, and UN/PVOs/NGOs/IOs.
- Offer methods to coordinate and support disaster response activities among the above groups.
- Maintain a current list of liaison contacts for the above groups, and provide it to other DART members as needed.

- Share DART reports and accomplishments with the above groups.
- Document liaison activities.

c. Demobilization

See section E, General Checklist for ALL DART Members, in this chapter.

6. Contracting Officer

The Contracting Officer is responsible for negotiating, executing, amending, and administering contracts, grants, and cooperative agreements with UN/PVOs/NGOs/IOs and contractors in the field. Contracting Officers are unique in that they bring with them to the field a USAID warrant authority. The Team Leader does not have the warrant authority and therefore works with the Contracting Officer. Because of the unique authorities and responsibilities inherent in the Contracting Officer's warrant authority, the Contracting Officer reports to the Team Leader for all DART activities except those inherent to the warrant. Specific responsibilities of the Contracting Officer are as follows.

a. Predeparture

- Contact the Team Leader, and receive a general briefing. In addition to the General Checklist for All DART Members in section E, discuss:
 - The level of review desired for contracts and grants.
 - Reporting relationships and points of contact with USAID/Embassy and OFDA/W.
 - Awareness by USAID Financial Management Office of the deployment of the DART and its possible workload consequences.
 - Types (if any) of USG-funded relief grants or contracts currently in place or submitted for the affected country.
 - Relationships with other DART members regarding grants and contracts, such as Program Officer or Field Officer.
 - Types and levels of contract support to be provided to DART by OFDA's grants or contracting review function and USAID's Contracts Office.
 - Funding cable for team support—amount and fiscal data.

- Disaster funding and funding by other USG agencies, such as the Department of State and DOD, and administration of funds.
- Ramifications for contracting function of the “notwithstanding” clause of the FAA.
- Contact USAID/Embassy to discuss contracting and support issues. Obtain names and telephone numbers of EXO and controller or person responsible for receiving DART allocations.
- Obtain copies of pertinent USAID directives dealing with disaster assistance, FFP, grants, and contracts.
- Obtain copies of the latest OFDA *Guidelines for Proposals and Reporting*, available on the DART Tools CD. The guidelines also can be obtained from the OFDA/W Disaster Response and Mitigation Division.
- Ensure the acquisition and proper shipment of computer equipment (hardware and software) and office supplies for the contracting function.

b. In-Country

(1) Immediate Actions

- Establish contacts with USAID/Embassy. Determine reporting relationships and ability to support the DART with personnel, office equipment, space, transportation, and procurement. Determine availability of work space, local hires, equipment, supplies, and transportation. Specifically discuss:
 - Methods of communication with USAID/Embassy (phone, fax, radio, e-mail).
 - Methods DART can use to reduce its impact on the USAID/Embassy.
- Select a worksite, set up equipment, and begin operations.
- If necessary, prepare and execute contracts for the rental of buildings, vehicles, and equipment. Hire local personnel as needed.

(2) Ongoing Actions

- Establish an accounting and tracking system to ensure that all fiscal actions are monitored, accurately documented, and filed in a safe place.

- Provide Team Leader with regular reports on the amount of funds obligated by the Contracting Officer.
- Contribute regularly to team planning process.
- Work closely with Program Officer in reviewing grant proposals for appropriateness to DART strategy, budget, implementation/completion timeframes, and ability of grantee to carry out proposal. Advise other functions on these actions.
- Ensure a complete transfer of knowledge of the operation of the contracting function if replaced before the demobilization of the team. Plan enough time for the transition.

c. Demobilization

- If Contracting Officer demobilizes and is not replaced before team demobilization, coordinate closely with Team Leader and Program Officer to ensure transfer of knowledge about the location and status of all appropriate files and paperwork.
- Ensure all contracts are closed or transferred as appropriate.
- See also DART Setup and Closeout Guidelines earlier in this chapter.

G. Logistics Section

The Logistics Section comprises the following positions:

- Logistics Coordinator.
- Fleet Manager.
- Aviation Officer.
- Supply Officer.

1. Logistics Coordinator

The Logistics Coordinator manages and supervises logistical and aviation support to the DART; ensures the team receives supplies, equipment, and services; orders, receives, distributes, and tracks USG-donated relief commodities; and manages the DART vehicle fleet. The Logistics Coordinator reports directly to the Team Leader. The logistics position relies heavily on the

support of the RMT Logistics Coordinator and the OFDA/W Logistics Office, which provide support and resources to the DART. Specific responsibilities of the Logistics Coordinator are described herein.

a. Predeparture

- Contact the Team Leader and receive a general briefing. In addition to the General Checklist for All DART Members in section E, discuss in-country logistical support needs to be communicated to USAID/Embassy. Develop DART logistics objectives.
- With the OFDA and RMT Logistics Officers:
 - Discuss DART logistics objectives.
 - Discuss the need for additional logistics staff in the field, and the duties of those team members.
 - Research/collect/conduct country-specific logistics assessments, including in-country resources.
 - Confirm status of stockpile supplies and procedures for supply requests.
 - Discuss the need for equipment and supplies to support the DART. Specify the weight, cubes, and number of pieces, and arrange for special handling requirements as needed.
 - Discuss the need for DART vehicles, and request transport if required.

b. In-Country

(1) Immediate Actions

- Define and acquire the immediate needs of the DART.
- Assess the affected country and other response organizations' logistical abilities to manage the situation. Recommend USAID/OFDA assistance if appropriate, and review and recommend possible grants with the Team Leader and Planning Coordinator.
- Become familiar with local transport resources in person. Make local contacts with USAID/Embassy logistics officers, affected country officials, other assisting country teams, UN/PVOs/NGOs/IOs logistics officers, and transport companies. Investigate:

- Reputable agents.
- Airport, road, rail, and port conditions and access; airport/port operation procedures, capabilities, and conditions; landing/quay costs; unloading and loading support equipment available at airports and ports.
- Warehousing resources, conditions, availability, and cost.
- Trucking and rail capacity and resources; fuel availability; local road conditions.
- Security issues.
- Availability of qualified local personnel for logistical support.
- Vehicle maintenance options.
- USAID/Embassy capabilities, availability, and use of applicable transportation, storage, and supply resources.
- Government border and customs procedures and use of waivers for expediting receipt of goods.
- Establish an accountability and management system for relief commodities. The system could include receiving, storing, securing, transporting, and tracking distribution of commodities to final beneficiary destination. This management system will be critical for reporting.
- Establish an accountability and management system for vehicles. The system will include vehicle setup and initial inspection, registration and insurance, maintenance provisions and tracking, and driver training. Also integral to vehicle management will be close team coordination with:
 - Communications Officer on communication equipment operations and monitoring.
 - Safety/Security Officer on driving rules and restrictions.
 - Administrative Coordinator on establishment of maintenance contracts, driver hiring, and fueling arrangements.

- Discuss procurement and contract procedures for transportation, storage, hiring of personnel, and vehicle maintenance with the Administrative Coordinator.
- Oversee the establishment of an accountability and management system for team equipment and supplies. The system will likely include receiving, inventory, storing, checkout and turn-in procedures, tracking, and possibly training.
- Establish a process for DART logistical support requests.
- Set the logistics staff's work schedules.
- Oversee the preparation of the DART transportation plan. Submit to the planning function.
- Evaluate the need for more personnel or resources to meet needs.

(2) Ongoing Actions

- Review resource requests with the Team Leader.
- Ensure that the distribution process gets relief supplies to appropriate recipients.
- Continuously assess and determine overall humanitarian community logistical situation. Recommend appropriate USAID assistance, and review and recommend possible grants with the Team Leader and Planning Coordinator.
- Coordinate transport, storage, distribution, and customs clearance of incoming shipments of emergency relief supplies, DART equipment, personnel, and vehicles.
- If UN Joint Logistics Center or other organized logistics units are present, stay closely connected and involved in operations and issues.
- Report current status on receipt and distribution of emergency relief supplies to DART Information Officer and RMT/OFDA Logistics as required.
- Review the need for replacement parts, equipment, and supplies. Provide information on stock levels and anticipated needs, and make requests through the chain of command. Coordinate this activity with

other DART members and the OFDA/W Logistics Office as necessary.

c. Demobilization

- With the Administrative Coordinator, conclude all contracts (personnel and materials) and payments.
- Ensure that all equipment is accounted for. Finalize all necessary documentation for transfer of assets or return shipment to the United States, including completion of customs documents. Ensure that appropriate documentation is sent to OFDA/W.
- Collect and send appropriate continuity documentation to the OFDA/W Logistics Office.

2. Fleet Manager

The Fleet Manager manages the DART's vehicle fleet. The Fleet Manager ensures vehicles are maintained and in good working order, maintains proper documentation, organizes dispatch and scheduling, provides driver training and supervision, and incorporates necessary safety and security precautions. The Fleet Manager reports directly to the DART Logistics Coordinator. Specific responsibilities of the Fleet Manager are outlined below and described in depth in the OFDA *Fleet Manager Handbook*, available on the DART Tools CD. The handbook can be obtained from the Operations Division of OFDA.

a. Predeparture

- With the DART Logistics Coordinator, identify DART vehicle requirements.
- With the OFDA and RMT Logistics Officers:
 - Research/collect/conduct country-specific assessments for operating conditions, security situation, appropriate vehicle types, specifications, and available resources.
 - Coordinate preparation and shipment of DART vehicles as required.
 - Gather necessary administrative forms that will be required in-country.

b. In-Country

(1) Immediate Actions

- Become familiar with local transport and vehicle maintenance resources in person. Make local contacts with UN/NGO logistics officers, USAID/Embassy logistics officers, maintenance companies, and others as appropriate. Confirm:
 - Reputable agents, road conditions and access, fuel availability, security issues, and vehicle maintenance options.
 - USAID/Embassy capabilities, availability, and use of applicable storage and supply resources.
 - Government driving laws and regulations, vehicle registration and insurance requirements, border and customs procedures, and use of waivers for expediting receipt of vehicles.
- Ensure that a reliable vehicle accountability and management system is in place. The system will include vehicle setup and initial inspection, registration and insurance, maintenance provisions and tracking, and driver training. Ensure close coordination with:
 - Communications Officer on clearance of communication equipment through customs and equipment operations and monitoring.
 - Safety/Security Officer on driving rules and restrictions.
 - Administrative Coordinator on maintenance contracts, hiring drivers, and fueling arrangements.
- Establish vehicle dispatch procedures.
- Establish vehicle recordkeeping procedures.

(2) Ongoing Actions

- Manage dispatch and schedule of vehicle usage.
- Conduct driver training.
- Coordinate vehicle requirements, ordering of spare parts, and regular and timely maintenance. Coordinate this activity with other DART members and the OFDA/W logistics team as necessary.

- Monitor driver performance and the security situation. Make adjustments in routine accordingly.
- Ensure upkeep of documentation recording vehicle usage and mileage, and maintenance and accident reports.

c. Demobilization

- With the Administrative Officer, conclude all contracts (personnel and materials) and payments.
- Ensure all equipment is accounted for. Finalize all necessary documentation for transfer of assets or return transport.
- Collect and send appropriate continuity documentation to the OFDA/W Logistics Office.

3. Aviation Officer

On rare occasions, the DART may require an Aviation Officer to manage the DART's aviation resources. The Aviation Officer may also perform an operational function, such as managing aerial spraying activities. The Aviation Officer reports directly to the Logistics Coordinator. If the Aviation Officer is also performing operational activities, the Logistics Coordinator and the Operations Coordinator will jointly coordinate aviation activities. Specific responsibilities of the Aviation Officer can be provided by the OFDA/W Logistics Office, if required, and are detailed in the DART Tools CD.

4. Supply Officer

On rare occasions, the DART may require a Supply Officer to manage the ordering, receiving, inventorying, storing, issuing, and accounting of OFDA relief commodities. The Supply Officer reports directly to the Logistics Coordinator. Specific responsibilities of the Supply Officer can be provided by the OFDA/W Logistics Office, if required, and are detailed in the DART Tools CD.

H. Communications Section

The Communications Officer is typically the only position in this section. Based on the anticipated location, size, and duration of the DART, the Communications Officer may recommend the deployment of an Information Technology team member to assist in the setup of the DART.

1. Communications Officer

The Communications Officer manages DART communications, supervises and trains personnel in the use and operations of equipment and systems, and develops and implements the DART communications plan. The Communications Officer reports directly to the Team Leader. Specific responsibilities of the Communications Officer are as follows.

a. *Predeparture*

- Attend general briefings.
- Confer with OFDA Communications Officer. In addition to the general checklists, discuss initial team communications requirements including:
 - Personnel safety and security.
 - Air-to-ground communications needs.
 - Planning of communications setups, personnel requirements, etc.
 - Operational communications (search and rescue, etc.).
 - DART headquarters communications (intraregion) to DART personnel worksites, USAID/Embassy, affected-country officials, and UN/PVOs/NGOs/IOs.
 - DART headquarters communications (interregion) to OFDA/W and other areas outside the region as necessary.
 - In-country communications support capabilities and availability of:
 - USAID/Embassy communications.
 - PSTN (public switched or local telephone system)/VSAT circuits for voice and e-mail capability.
 - USAID Computer Net (e-mail).
 - Existing radio frequency networks and authorizations.
 - UN/PVO/NGO/IO equipment and frequencies.
 - AC power, adapters, etc. (or need for generators).
 - Amateur radio networks (ARRL), Military Affiliate Radio System (MARS).
 - Internet access, etc.

- Request USAID/Embassy to provide latest authorized frequency assignments for HF/VHF/UHF radios if available.
- Assemble the required documents, manuals, and communications equipment and coordinate packaging for shipment. Specify weight, cubes, and number of pieces, and arrange for special handling requirements (radio licenses or authorizations, Air Way Bills [AWB], customs declarations, etc.).
- Acquire local list of communicators.
- Acquire current *World Radio and TV Handbook* or other reference listing of radio frequencies.
- Ensure all DART members have OFDA eRoom accounts and have been added to the appropriate DART eRoom.

b. In-Country

(1) Immediate Actions

- Set up initial communications link to OFDA/W (typically satcom, voice/data).
- Establish/use existing personnel safety and security radio net (typically VHF/UHF voice).
- Perform immediate initial evaluation of communications situation.
- Obtain information from USAID/Embassy on frequency uses, call signs and authorizations, available personnel, communications facilities, and USAID Computer Net availability.
- Select communications site with considerations given to highest available elevation with appropriate clearing for radio and satellite terminal antennas.
- Set up Communications Center at DART headquarters, suboffices, and residences as required.
- Develop interim communications plan.
- Instruct DART members on use of equipment.

(2) Ongoing Actions

- Continually review and revise communications plans as conditions change.

- Assist and train DART personnel in the efficient and proper use of communications equipment.
- Keep OFDA informed of communications methods, procedures, and links.
- Ensure the proper use of radio protocols and frequencies.
- Keep radio logs as necessary.

c. Demobilization

- Review communications requirements and recommend the release of excess equipment and communications personnel.
- Maintain adequate equipment and support personnel to support the DART until departure.
- Ensure equipment is accounted for.
- Ensure equipment being released for shipment is properly packaged and documents are properly prepared (AWB, manifests, customs declarations, etc.).
- Compile communications' After Action Report, and prepare or provide documentation for the team's After Action Report.
- File radio logs if maintained.

I. Operations Section

The Operations Section can include the following positions:

- Operations Coordinator.
- Medical Officer.
- USAR Task Force Leader.
- Technical/Scientific Operations Specialists.

Specific responsibilities for each position are listed below.

1. Operations Coordinator

The Operations Coordinator manages tactical operations, such as search and rescue, medical/health, technical support, and aerial operations. The Operations Coordinator reports directly to the Team Leader. Specific responsibilities of the Operations Coordinator are as follows:

a. Predeparture

- Contact the Team Leader and receive a general briefing. In addition to the General Checklist for All DART Members in section E, discuss:
 - In-country operational support needs to be communicated to USAID/Embassy.
 - Operational response activities by the affected country.
 - Operational response activities pending by other assisting countries and the UN/PVOs/NGOs/IOs.
 - Type of onsite operational coordination occurring among the affected country, assisting countries, and UN/PVOs/NGOs/IOs.
 - Technical or scientific specialists required for the mission.
 - Safety/security situation as it might affect operational activities.
- Ensure that adequate communication equipment is ordered to support anticipated team operations.

b. In-Country

(1) Immediate Actions

- Assess the affected country's and other response organizations' abilities to carry out relief operations. Make a determination on the best use of assigned operational resources.
- If the plan requires an immediate tactical response, assist in selecting a worksite, setting up equipment, and beginning the operation.
- With the Communications Officer, determine communications needs, develop a communications plan, and submit it to the Planning Coordinator.
- Develop a staff work schedule, considering the need for 24-hour operation.
- Provide operational input to the Safety/Security Plan.
- With the Press Officer, establish onsite media management procedures.

- If the operational plan does not require an immediate tactical response, offer technical assistance to existing tactical operations.

(2) Ongoing Actions

- Contribute regularly to the team planning process by recommending operational tactics to meet team objectives.
- Update the Team Leader, planning function, and appropriate staff on the current situation, including potential or impending life-threatening safety and/or security situations for team members or victims.
- Coordinate with the logistics function to ensure that operational requirements are being met.
- Keep operations staff briefed on the changing situation.
- Conduct frequent debriefings with key staff to review problems and work accomplishments.
- Coordinate continuously with the affected country's response organization, other assisting country response teams, and any onsite coordination organizations, such as an onsite operations coordination center (OSOCC). Complement ongoing activities.

c. Demobilization

See section E, General Checklist for ALL DART Members, in this chapter.

2. Medical Officer

The Medical Officer manages medical care operations. This position will be filled on the DART when DART operations include assisting disaster victims directly with medical care. The Medical Officer reports directly to the Operations Coordinator. Specific responsibilities of the Medical Officer are as follows.

a. Predeparture

- Contact the OFDA/W Health Officers and obtain information on the following:
 - Medical capabilities in the affected country and at the disaster site.
 - UN/PVOs/NGOs/IOs working in the affected country and the types of programs currently being conducted.

- Types of USG-sponsored medical personnel and material assets available for disaster response and methods of obtaining them.
- Any medical responses being planned or carried out by other assisting countries or organizations.
- Ensure that any specialized equipment is properly prepared for shipment.
- Contact medical personnel, brief them, and ensure their preparedness.

b. In-Country

(1) Immediate Actions

- Perform an immediate initial evaluation of the health and medical situation. Discuss needs with local health officials, USAID/Embassy, other assisting country response teams, and UN/PVOs/NGOs/IOs.
- Assess the affected country's and other response organizations' abilities to manage the situation. Make a determination of the need to activate a medical unit immediately.
- Determine the local medical capabilities and contacts.
- Identify potential societal or gender issues affecting patient care.
- If the plan requires immediate patient care, assist in selecting the worksite, setting up equipment, and beginning operation (if such resources are a part of the DART).
- Develop the staff work schedule.
- Establish medical priorities. Validate the triage process.
- Provide leadership and technical guidance and resolve any coordination and personnel problems in the unit.
- Provide backup support and consultation to the Safety/Security Officer, including monitoring DART members for signs of critical-incident stress syndrome.
- If the operational plan does not require immediate patient care, offer technical assistance to the existing medical operations.

(2) Ongoing Actions

- Ensure that proper medical and health practices and standards are observed, including gender concerns.
- Coordinate continuously with the search and rescue medical team manager, local Ministry of Health, USAID/Embassy, other assisting country response teams, and UN/PVOs/NGOs/IOs.
- Coordinate with the Safety/Security Officer on a medical evacuation plan and health and safety issues for DART members.

c. Demobilization

See section E, General Checklist for ALL DART Members, in this chapter.

3. Urban Search and Rescue Task Force Leader

The USAR Task Force Leader manages search and rescue operations and reports directly to the Operations Coordinator. Additional information on USAR operational response activities is located in FEMA's *Urban Search and Rescue Response System Field Operations Guide* or its Operations Manual. Specific responsibilities of the USAR Task Force Leader are as follows.

a. Predeparture

- Contact the Operations Coordinator and receive a general briefing. In addition to the General Checklist for All DART Members in section E, discuss:
 - Type and quantity of communication equipment for USAR operations.
 - Construction techniques used in the affected country.
 - Roster of other international response resources.
- Contact USAR personnel, brief them, and ensure their operational readiness.
- Coordinate the equipment cache for transport. Specify its weight, cube, and number of pieces, and arrange for special handling requirements.
- Coordinate departure requirements as outlined by the International Search and Rescue Advisory Group (INSARAG) *International Search and Rescue Response Guidelines* (www.reliefweb.int/undac/documents/insarag/guidelines/topics.html).

b. In-Country

(1) Immediate Actions

- Coordinate arrival requirements as outlined by the INSARAG *International Search and Rescue Response Guidelines*.
- If the plan requires immediate USAR response, assist in selecting the worksite, setting up equipment, organizing other international USAR teams, and beginning operation.
- Develop a staff work schedule for the task force, considering the need for 24-hour operation.
- With the Press Officer and Operations Coordinator, establish an onsite media management protocol, and brief the unit leaders.
- If the operational plan does not require an immediate tactical response, offer technical assistance to existing USAR operations.

(2) Ongoing Actions

- Coordinate closely with the Technical/Scientific Operations Specialists.
- Ensure that proper safety practices and standards are observed. Immediately shut down any life-threatening USAR activity.
- Coordinate operational requirements as outlined by the INSARAG *International Search and Rescue Response Guidelines*.

c. Demobilization

- Coordinate demobilization requirements as outlined by the INSARAG *International Search and Rescue Response Guidelines*.
- See the General Checklist for All DART Members in section E of this chapter.

4. Technical/Scientific Operations Specialists

Technical/Scientific Operations Specialists provide DART with technical and scientific expertise pertaining to the disaster. Specialists assigned to the team may be from several different fields, including shelter/housing, volcanology, geology, structural

engineering, fire suppression, or hazmat. These specialists should not be confused with specialists specifically assigned to the DART planning function to provide assessments in technical and scientific areas (see Planning Section, section J, part 5, in this chapter).

When assigned to the operations function, Technical/Scientific Operations Specialists are expected to perform operational activities, such as working with the affected country and other organizations in teaching the proper use of USG-supplied relief commodities, taking measurements and samples, monitoring geologic activities, or providing technical advice in fire suppression and hazmat handling. These specialists report directly to the Operations Coordinator. Specific responsibilities of Technical/Scientific Operations Specialists are as follows.

a. Predeparture

- Contact the Operations Coordinator and receive a general briefing. In addition to the General Checklist for All DART Members in section E, discuss:
 - In-country support needs.
 - Current technical resources and relief commodities requested of the USG by the affected country (obtain a list).
 - Affected country's technical/scientific capabilities to use resources and commodities.
 - Status of OFDA stockpile items and stockpile usage procedures.
 - Availability of in-country support services.
 - Contact list for technical/scientific government officials and organizations in the affected country.
- Coordinate the acquisition and shipping of equipment.
- Consider the need for specialized equipment or adapters for the affected country.
- Specify the weight, cubes, and number of pieces, and arrange for special customs clearance requirements.

b. In-Country

(1) Immediate Actions

- Establish contacts with USAID/Embassy and local counterpart experts. Share information on the disaster and predicted technological occurrences.

- Assess the affected country's and other response organizations' abilities to use technical/scientific resources and commodities provided by the USG, and where resources and commodities would be best used.
- If emergency shelter is required, work with the logistics function to:
 - Perform a thorough damage and needs assessment of the shelter situation.
 - Move plastic sheeting, if needed, as close as possible to the area of victims' needs.
 - Establish a location for distribution, such as a large gym or soccer field. Ensure security, and prevent distribution to inappropriate recipients.
 - Establish a system of tracking and accounting with local officials or UN/PVOs/NGOs/IOs.
 - Conduct training on the best use of plastic sheeting, distribute instructions, and provide assistance.
 - Coordinate closely with local housing authorities and USAID/Embassy specialists on the local shelter situation.

(2) Ongoing Actions

- Ensure the acquisition and shipping of appropriate technical/scientific equipment and relief supplies, including such items as OFDA plastic sheeting and seismic monitoring devices. Specify the weight, cubes, and number of pieces, and arrange for special handling requirements as needed.
- Advise the Operations Coordinator of technological or scientific problems.
- Offer assistance to existing technical and scientific operations.

c. Demobilization

See section E, General Checklist for ALL DART Members, in this chapter.

J. Planning Section

The Planning Section can include the following positions:

- Planning Coordinator.
- Information Officer.
- Field Officer.
- Program Officer.
- Technical/Scientific Operations Specialists.

Specific responsibilities for each position are listed below.

1. Planning Coordinator

The Planning Coordinator manages DART planning, assessing, reporting, personnel tracking, information analysis, and documentation activities and makes recommendations based on an analysis of information. The Planning Coordinator reports directly to the Team Leader (or the Deputy Team Leader if applicable) and can serve as the Deputy Team Leader if that position is not filled. Specific responsibilities of the Planning Coordinator are as follows.

a. *Predeparture*

- Contact the Team Leader, and receive a general briefing. In addition to the General Checklist for All DART Members in section E, discuss:
 - Reporting guidelines, procedures, formats, and timeframes for DART cables, sitreps, and final disaster reports.
 - Points of contact for reporting information to USAID/Embassy, OFDA/W, UN, and the affected country.
 - Types and frequency of assessments required.
 - Types of USG-funded grants and/or contracts currently in place in the affected country.
 - Level of monitoring/assessment of present grants and/or contracts to be performed by DART.
 - Level of review expected for new proposals for relief activities.
 - Funding levels and mechanisms available to DART.

- Discuss the guidelines, procedures, formats, and timeframes for information reporting with the OFDA/W Information Specialist responsible for the disaster relief effort.
- Ensure the acquisition and shipping of special supplies for the planning function.
- Work with the Communications Officer to ensure that equipment is sufficient to meet requirements for conducting assessments, tracking resources, updating current events, and conveying information back to Washington.
- With the Team Leader and OFDA staff, conduct the initial DART briefing. Cover all items in the “In Transit” checklist in section E and provide a security briefing, travel advisory alert, public health bulletin, and a list of do’s and don’ts.
- Ensure that the planning staff obtains copies of USG-funded relief activity grants and/or contracts that the DART will be monitoring in the affected country.
- Obtain a copy of the OFDA *Guidelines for Proposals and Reporting*, available on the DART Tools CD or through the OFDA/W Disaster Response and Mitigation Division.
- Work with the Information Officer (or Geographic Information Officer) to ensure that adequate maps of the affected country and mapping supplies are obtained.

b. In-Country

(1) Immediate Actions

- Locate the affected country’s emergency management organization and/or OSOCC; report the DART’s capabilities, requirements, and objectives; and receive work area assignments (if the DART has an operational component).
- Set up an initial team briefing. Set the time, place, and list of attendees for future planning meetings.
- Supervise the formulation of a team operational plan based on immediate evaluations from all functions.
- Help the Team Leader establish the DART headquarters and begin operation.
- Oversee the damage and needs assessment process and the development of a map of the affected area showing location of DART and grants/contracts activities.

- At the DART headquarters, oversee the setup of information displays, including organizational charts, resource tracking systems, maps, chronologies of major events and team activities, and sitreps (see also “DART Setup and Closeout Guidelines” in the beginning of this chapter).
- Develop a staff work schedule.
- Establish an operational plan development process with contributions from DART members. Decide if the plan will be given verbally or in writing to DART members. The plan should include:
 - Operational strategy and objectives (Team Leader and Planning Coordinator).
 - Tactical actions (Operations Coordinator).
 - Work assignments (Operations and Planning Coordinators).
 - Communications plan (Communications Officer).
 - Transportation plan (Transportation Officer).
 - Commodity distribution plan (Logistics Coordinator).
 - Work maps (Information Officer).
 - Safety and security (including Medevac) plan (Safety/Security Officer or Administrative Officer).
 - Programming plan (Program Officer).
 - Reporting plan (Information Officer).
 - Demobilization plan (Planning Coordinator).
- Determine a daily DART briefing and debriefing procedure and time schedule, and inform the Team Leader.
- With the Press Officer, establish procedures for press visits to command post (access to visual displays, sitreps, resource status information).
- Establish liaisons with UN/PVOs/NGOs/IOs, assisting country teams, donor countries, and the affected country to share information related to the disaster.

(2) Ongoing Actions

- Conduct regular planning briefing and debriefing sessions. Ensure that:
 - Appropriate DART members submit information on time.

- Sessions are objective-oriented.
- Strategy and tactics are developed and understood.
- Sessions are brief, conducted on time, and have proper attendance.
- Activities are well-documented.
- Information is properly distributed.
- Displays and maps are used for illustration and are available as needed.
- Ensure the satisfactory completion and reporting of assessments.
- Ensure the monitoring of USG-funded relief activities as required.
- Identify and request Technical/Scientific Operations Specialists as needed. Brief and supervise these specialists when deployed with the DART.
- Ensure that DART members regularly submit updates on situation status, work progress, and significant events.
- Oversee the situation and cable reporting/distribution process.
- Oversee the proper documentation of all DART activities.
- Conduct a daily critique of the operational plan's effectiveness, analyze information gathered by the planning staff, and make the following recommendations to the Team Leader:
 - Alternative team objectives.
 - Increase or decrease in the resources/activities needed to complete team objectives as objectives change.
- Ensure the collection of unit logs from team members.

c. Demobilization

- Supervise the development of the demobilization plan.
- Ensure that all DART members have submitted the necessary information for the final disaster report.
- Submit a draft of the final disaster report to the Team Leader for review.

- Complete a final disaster report, and present it to the Team Leader.
- Submit all reports, evaluations, unit logs, and personnel time records to the Team Leader.
- Compile information (lessons learned, points of contact, reports, etc.) that would be useful for the After Action Workshop.

2. Information Officer

The Information Officer collects, analyzes, reports, and distributes information on DART activities; prepares all sitreps and assists with the preparation of cables, briefing papers, the DART operational plan, maps, and final disaster report; tracks DART resources; and coordinates information-gathering and reporting activities with UN/PVOs/NGOs/IOs, other donor countries, and the affected country. The Information Officer reports directly to the Planning Coordinator. Specific responsibilities of the Information Officer are as follows.

a. Predeparture

- Contact the Planning Coordinator and receive a general briefing. In addition to the General Checklist for All DART Members in section E, discuss:
 - Reporting guidelines, procedures, formats, and timeframes for DART cables, sitreps, and final disaster reports.
 - Points of contact for reporting information to the USAID/Embassy, OFDA/W, UN, and affected country.
- Obtain or create a contact list of the UN/PVOs/NGOs/IOs and donor countries (with names and numbers if possible) that are working on disaster relief in the affected country.
- Discuss with the OFDA/W Information Specialist responsible for the disaster the guidelines, procedures, formats, and timeframes for preparing information.
- Identify, prepare, and arrange for shipping of special supplies needed for the DART planning function.
- Obtain adequate maps of the affected area and mapping supplies.

b. In-Country

(1) Immediate Actions

- Perform an immediate initial evaluation of the information unit's needs. Coordinate with the administrative function.
- Assist in the preparation of the DART operational plan.
- Set up and maintain a tracking system for all DART members.
- Work with the Logistics Officer to set up and maintain a tracking system for USG commodities. Use this tracking information for the sitreps.
- Establish local contacts and liaisons with USAID/Embassy.
- Prepare an initial map of the affected area and USG-funded activities in the area.
- Establish a clearance process for sitreps and cables with the Team Leader/USAID/Embassy.
- Develop internal and external distribution lists for sitreps and operational plans.
- Establish the frequency for producing sitreps and cables with the Team Leader/USAID/Embassy.

(2) Ongoing Actions

- Prepare and obtain clearance for sitreps according to identified procedures.
- Debrief Field Officer(s), Program Officer(s), and Technical/Scientific Operations Specialist(s).
- Prepare and distribute DART operational plans as needed (see the Planning Coordinator section for elements of the plan).
- Coordinate information gathering and sharing with other UN/PVOs/NGOs/IOs, other donor countries, and the affected country. This includes attending coordination meetings.
- Take field trips, and assist with assessments as necessary to collect onsite field information.
- Continually collect, verify, analyze, and update information on the general disaster status, progress of

relief activities, areas of concern, maps, displays, and personnel and resource status locations from DART members and other sources.

- Document, distribute, and file the planning function information, including sitreps, maps, cables, field reports, operational plans, logs, and meeting notes.
- Make recommendations on future DART actions.
- Provide the press with access to displays and information at prearranged times, in coordination with the Press Officer.
- As requested, provide copies of documents for meetings and briefings.
- Record significant actions and events in the unit log each day and file.
- Collect and file unit logs from all DART personnel for use in the disaster chronology.

c. Demobilization

- Assist with the preparation of the final disaster report by collecting all reports, evaluations, field reports, unit logs, and personnel time records from DART personnel, and submit to Planning Coordinator.
- Ensure that the final DART documentation is distributed to local USAID/Embassy before departure.
- Prepare planning and reporting function materials, supplies, and files for return shipment to the United States. Account for missing items.
- If a handoff of reporting responsibilities to another USAID office is required, provide a briefing and/or training for the staff.

3. Field Officer

The Field Officer conducts field assessments of damage and needs in the affected areas; monitors the effectiveness of relief activities conducted by the USG, the affected country, UN/PVOs/NGOs/IOs, and other donor countries; makes recommendations on areas of focus for USG relief efforts; and provides written assessment reports to the Information Officer. The Field Officer reports directly to the Planning Coordinator. Specific responsibilities of the Field Officer are as follows.

a. Predeparture

- Contact the Planning Coordinator and receive a general briefing. In addition to the General Checklist for All DART Members in section E, discuss:
 - Guidelines, procedures, formats, and timeframes for field assessment reports.
 - Types and frequency of assessments required by the DART objectives.
 - Safety and security.
- Obtain a list of UN/PVOs/NGOs/IOs and donor countries working on disaster relief in the affected country. Obtain lead points of contact and numbers if possible.
- Obtain a list of activities being carried out by the above mentioned organizations and countries.
- Obtain maps of the affected area.

b. In-Country

(1) Immediate Actions

- Through initial contacts, obtain current information on the locations and types of relief activities being conducted by the groups mentioned above.
- Transpose the above information to a map.
- Share the above information with the Information Officer.
- Begin an initial field assessment based on objectives and priorities in the initial operational plan.

(2) Ongoing Actions

- Continue field assessments as required.
- Continue to provide the Information Officer with assessment information.
- Continue to provide recommendations on assessment information.
- Provide inputs to the operational plan.
- Attend briefings and debriefings as required.

c. Demobilization

See the General Checklist for All DART Members in section E of this chapter.

4. Program Officer

The Program Officer assesses the effectiveness of USG-funded relief projects conducted by UN/PVOs/NGOs/IOs and coordinates with these groups and the planning staff to identify potential areas of focus for USG relief projects; performs initial reviews of grant/contract proposals submitted to the DART and/or OFDA/W by PVOs/NGOs/IOs; and makes recommendations on improvements to the proposals and on whether to fund projects. The Program Officer reports directly to the Planning Coordinator. Specific responsibilities of the Program Officer are as follows.

a. Predeparture

- Contact the Planning Coordinator and receive a general briefing. In addition to the General Checklist for All DART Members in section E, discuss:
 - Types and frequency of monitoring/assessment of grant activities required.
 - Level of review expected for new proposals for relief projects.
- Obtain a copy of USG-funded relief activity grants and/or contracts in place in the affected country.
- Obtain a list of the relief projects being funded by UN/PVOs/NGOs/IOs and donor countries in the affected country. Get contact names and phone numbers if possible.
- Meet or contact the OFDA/W PVO coordinator to discuss UN/PVO/NGO/IO activities (occurring or expected) in the affected country.
- Meet or contact the OFDA/W staff members dealing with UN/PVO/NGO/IO grant/contract proposals to receive a briefing on the OFDA grant/contract review process.
- Obtain a copy of the annual program statement (APS) for this disaster, if applicable.
- Obtain a copy of OFDA *Guidelines for Proposals and Reporting*, available on the DART Tools CD or through OFDA/W Disaster Response and Mitigation Division.
- Obtain maps of the affected area.

b. In-Country

(1) Immediate Actions

- Establish liaisons with UN/PVOs/NGOs/IOs currently performing USG-funded relief projects.
- Work with the OFDA/W Regional Team or the RMT Program Officer to develop and publish an APS, if appropriate.
- Locate USG-funded relief grants/contract/projects.
- Share the above information with the Information Officer.

(2) Ongoing Actions

- With the OFDA/W Regional Team or the RMT, ensure that all program activities are entered into the appropriate USAID financial accounting systems.
- Conduct field monitoring of USG-funded projects and assessments of affected areas as required.
- Provide continuing updates to the Information Officer on assessment information, program activity information, and information provided in discussions with partners.
- Continue to coordinate with USG-funded groups and potential partners.
- Recommend relief activity areas that need to be addressed.
- Discuss new project proposals with potential for affected areas.
- Review and recommend changes to, and/or action on, new proposals.
- Be sensitive to gender and protection needs/issues when evaluating and recommending relief activities.
- Provide inputs to the operational plan.
- Attend briefings and debriefings as required.

c. Demobilization

See the General Checklist for All DART Members in section E of this chapter.

5. Technical/Scientific Operations Specialists

On a DART, technical and scientific specialists provide expertise in their specific field. These specialists assess the disaster situation, identify disaster relief/rehabilitation needs, review in-place USG-funded projects, and, with other DART members, make recommendations for ongoing and future USG-funded interventions.

Specialists assigned to a DART may be from several different technical/scientific fields, including shelter/housing, water, sanitation, food, nutrition, health, infrastructure (transportation and utilities), volcanology, geology, hydrology, and fire suppression. Examples of these specialists include Centers for Disease Control and Prevention epidemiologists and doctors, Public Health Service officers, FFP officers, civil engineers, protection/abuse prevention officers, transportation experts, disaster consultants, and USDA Forest Service fire-suppression officers. Technical/Scientific Operations Specialists report to the Planning Coordinator. Specific responsibilities of Technical/Scientific Operations Specialists are as follows.

a. Predeparture

- Contact the Planning Coordinator for a general briefing. In addition to the General Checklist for All DART Members in section E, discuss:
 - Technical/scientific capabilities of the affected country.
 - Actions and capabilities of other UN/PVOs/NGOs/IOs and other donors.
 - Current technical/scientific resources and relief commodities requested of the USG by the affected country (obtain a list).
 - Affected country's ability to use the technical/scientific resources and commodities requested from the USG.
 - Availability of in-country support services.
 - Contact list for technical/scientific government officials and organizations in the affected country.
- Coordinate the acquisition and shipping of supplies and equipment.

b. In-Country

(1) Immediate Actions

- Contact technical/scientific experts at USAID/Embassy, UN/PVOs/NGOs/IOs, the affected country, and other

donor governments to assess the status of relief activities—to date and projected.

- Conduct additional assessments if important topics or geographic areas have not been addressed.
- Report on the situation in your area of expertise using existing information and a personal assessment. Include information on trends, the adequacy of existing resources, and current plans. Comment on the appropriateness of the USG technical resources and commodities in place and those requested. Recommend actions to address important unmet needs.

(2) Ongoing Actions

- Monitor implementation of the emergency response, with close attention to USG-funded efforts.
- Evaluate the impact of efforts, and make further recommendations as necessary.
- Work closely with the Field Officer and Program Officer to coordinate DART recommendations.

c. Demobilization

See the General Checklist for All DART Members in section E of this chapter.

d. Types of Technical/Scientific Operations Specialists

The position description is generalized for any Technical/Scientific Specialist assigned to a DART planning function. This guide does not contain position descriptions for every type of specialist that could be assigned to a DART. The following position descriptions and responsibilities, however, represent types of Technical/Scientific Operations Specialists that have been assigned to a DART in the past.

(1) Water and Sanitation Specialists

(a) In-Country

- Perform an immediate evaluation of the water and sanitation situation; discuss needs with local health and public works officials, USAID/Embassy, other response teams, and relief organizations dealing in water and sanitation; and assess the ability of the affected country's public works department to rehabilitate its systems.

- Conduct a thorough survey of the public water supply and waste management systems. Determine the needs for immediate repairs, and identify these areas on a map.
- Survey the water distribution and sanitation system in temporary shelter areas.
- Identify the areas in greatest need of corrective actions.
- Make recommendations on the best method of USG response to address the situation. Be sensitive to gender needs and local customs. Include ways to coordinate USG efforts with the local government, UN/PVOs/NGOs/IOs, and other donor government operations.

(2) Health Specialists

(a) In-Country

- Evaluate the health situation and existing factors that increase vulnerability to, or transmission of, disease. Discuss needs with the affected country's health officials, USAID/Embassy, UN/PVOs/NGOs/IOs, and other donors.
- Coordinate or aid the establishment of a disease and nutritional surveillance system, and collect data as necessary. Determine the cause or source.
- Advise local health officials on findings, and suggest prevention and control measures, including vector, food, and sanitation control, and the effect of these measures on food and water sources.
- Evaluate ongoing sanitary and/or public health programs and contributing causes for problems that these programs are attempting to address.
- Investigate unconfirmed reports of disease outbreaks and malnutrition.
- Coordinate continuously with the above groups. Encourage the designation of focal points for communication among long-term providers or affected country governments.
- Recommend how the USG should respond to the situation.

(3) Food Specialists

(a) In-Country

- Perform an immediate initial evaluation of the food security situation. Discuss with the affected country's officials, USAID/Embassy (FFP Officer if present), UN/PVOs/NGOs/IOs, and other donors. Collect information on:
 - Affected country's normal food production rates.
 - Affected country's normal food consumption rates and import requirements, if any.
 - Food production and consumption rates after the disaster.
 - Food assistance requirements to fill potential gaps or changes in the population's consumption requirements; compare the affected government's estimates with other nongovernment estimates.
 - Amount of locally available and imported food.
 - Amount of shortfall in food.
 - Amount of food, if any, in the pipeline from all sources.
 - FFP commodities potentially available, from where, and how long delivery will take. Consult with the responsible FFP Officer(s) in the field and/or FFP/W.
 - Normal food basket of the affected population, with acceptable alternatives.
 - Condition—from ports to victims—of the food distribution system, including the ability of food distribution organizations and the commercial market.
 - Availability of transportation to move food in the affected country or from a third country into the affected country.
- Review the food sector portions of proposals for their appropriateness to the disaster situation.
- Monitor food distribution, quantify losses if possible, and make recommendations for improvements.

- Coordinate with FFP Officer in-country and/or FFP/W, and provide recommendations on commodity transfers and funding requirements.

K. Administrative Section

The Administrative Section comprises the following positions:

- Administrative Officer.
- Administrative Support Specialist.

Specific responsibilities for each position are listed below.

1. Administrative Officer

The Administrative Officer manages the DART's fiscal and administrative activities; hires and manages local personnel; and procures supplies, services, and facilities for the DART. The Administrative Officer reports directly to the Team Leader. Specific responsibilities of the Administrative Officer are as follows.

a. Predeparture

- Contact the Team Leader, and receive a general briefing. In addition to the General Checklist for All DART Members in section E, the Administrative Officer should:
 - Discuss fiscal authorities and levels delegated to the Team Leader by OFDA/W and determine support levels and facilitation of distribution of administrative support cables.
 - Establish fiscal reporting requirements with USAID/Embassy and fiscal monitoring requirements for administrative fund cites.
 - Establish a contact with USAID/Embassy as liaison with the DART for administrative concerns.
 - Establish contact with the USAID Financial Management Office in-country, and discuss the possible workload consequences of the DART's presence.
 - Establish contact with OFDA/W Financial Management Office to facilitate the movement of DART funds.
 - Determine types and levels of administrative support to be provided by administrative function to DART.

- Research disaster funding by other USG agencies and how it is being administered.
- Determine DART member fiscal responsibilities and allowances, such as per diem versus purchase order for lodging, local travel, phone call policy, and limits on petty cash reimbursements.
- Discuss with General Counsel the ramifications for administrative function of the “notwithstanding” clause of the FAA.
- Accumulate emergency information on all DART members.
- Contact USAID/Embassy to discuss administrative support issues. Obtain names and telephone numbers of EXO and controller/FMO, or the person responsible for receiving DART allocations.
- Obtain copies of the pertinent USAID directives dealing with travel, administrative, and financial operations.
- Coordinate with computer and communications support for the acquisition of computer and communications equipment.

b. In-Country

(1) Immediate Actions

- Establish contacts with USAID/Embassy. Determine reporting relationships. Determine the Mission’s ability to support the DART with personnel, office equipment, space, transportation, and procurement; and the availability of local storage and work space, local hires, equipment, supplies, relief commodities, and transportation. Discuss:
 - Setting up a petty cash account.
 - DART member fiscal responsibilities and allowances, such as per diem versus purchase order for lodging, local travel, phone call policy, and limits on petty cash reimbursements.
 - Methods of communication with USAID/Embassy.
 - Motor pool procedures.
 - Procurement and customs procedures.
 - Check-cashing policy for team members.

- Travel office procedures.
- Local hire procedures.
- Potential International Cooperative Administrative Support Services budget issues.
- In coordination with the Logistics Officer, consider the following when leasing or purchasing vehicles:
 - Country laws on liability, insurance, licensing, and leasing.
 - Cost analysis between leasing with a package (driver, insurance, license) versus purchasing plus cost of driver, insurance, and license.
 - Fleet size and vehicle types.
 - Personnel use policy.
 - Availability of taxis (the key factor being the ability to communicate with the drivers).
 - Maintenance.
 - Disposal at the end of DART assignment.
- Consider the following when deciding on housing for DART members:
 - Availability of hotels versus alternate housing options.
 - Morale factor of long-term hotel living.
 - Group houses often lead to additional stress. Long-term individual apartments are optimum for DARTs exceeding 6 months, when possible.
 - The safety and security of potential facilities.
- Consider whether locally purchased equipment can be locally maintained when deciding to lease or purchase equipment.
- Select a worksite, set up equipment, and begin operations.
- Discuss staff work schedule with the Team Leader or Deputy Team Leader.
- Hire local personnel as needed. Consider the following when hiring locals for DART support:

- Country laws on hiring and USG FSN compensation plans.
- USAID/Embassy procedures for hiring local staff.
- Establish procedures for time and attendance and payroll.

(2) Ongoing Actions

- Establish a precise accounting and tracking system for OFDA fund cites.
- Provide the Team Leader with regular reports on DART funds.
- Provide assistance on pricing and payment mechanisms.
- Advise other functions on cost estimates for proposed actions.
- Oversee proper timekeeping procedures for all DART personnel.

c. Demobilization

- Provide notice within the terms of the lease, and follow lease procedures for inspection and turnover. Conduct the inspection with owners if possible.
- Ensure that arrangements are made for closing all purchase orders and for processing final bills.
- Ensure that arrangements are made for the proper disposition of any remaining facilities, equipment, and supplies, and/or ensure that equipment, files, and records are accounted for and prepared for return shipment to OFDA/W.
- Discuss all closeout procedures with USAID/Embassy staff.

2. Administrative Support Specialist

The Administrative Support Specialist provides administrative support to all DART functions. This position is usually filled by a local hire through the USAID/Embassy network or directly from the affected community. The Administrative Support Specialist reports directly to the Administrative Officer. The Administrative Support Specialist performs those functions delegated by the Administrative Officer. Those functions normally performed by the Administrative Support Specialist also include the following.

a. Predeparture

See the General Checklist for All DART Members in section E of this chapter.

b. In-Country

(1) Ongoing Actions (Performed for Various Functions)

- Provide unofficial interpretive and translation services.
- As requested, type, file, fax, and copy.
- Answer phones and radios, and keep communications logs.
- Act as a receptionist.
- Take and write up meeting notes.
- Assist in briefings.
- Provide expediting services as required.
- Assist in maintaining tracking systems by gathering information and filling out forms.
- Give general advice on local issues such as laws, customs, government and private sector, and locations of supplies, equipment, and commodities.

c. Demobilization

- Assist with preparation of DART documentation package.
- Complete paperwork on time and attendance.
- Ensure that equipment, files, and records are accounted for and prepared for return shipment to OFDA/W.

Chapter V

Commonly Used Acronyms and Terms



COMMONLY USED ACRONYMS AND TERMS

This chapter has two sections. Section A lists acronyms and terms used by the Office of Foreign Disaster Assistance (OFDA) and the humanitarian relief community. Section B lists acronyms and terms used by the Department of Defense (DOD) that a DART member may read or hear if he or she is coordinating assessment or relief activities with the military. For more information on the DOD, also refer to Appendix F, Working With the Military in the Field.

A. OFDA Acronyms and Terms

AID: U.S. Agency for International Development. Also known as USAID.

ARI: acute respiratory infection.

at-risk population: A group that may suffer the effects of drought, conflict, food insecurity, or other phenomena resulting in humanitarian hardship.

ATA: actual time of arrival.

ATD: actual time of departure.

AU: African Union. An organization, composed of 53 member states, whose aim is to promote peace, security, and solidarity on the African continent.

blended foods: Fortified/processed foods such as wheat-soya blend, corn-soya blend, and soya-fortified bulgur.

BOO: base of operations.

CDC: Centers for Disease Control and Prevention.

CIDA: Canadian International Development Agency.

CIDI: Center for International Disaster Information. USAID-funded clearinghouse for public donations and volunteer information during overseas disasters.

CMM: USAID Office of Conflict Management and Mitigation.

Cold Chain: The refrigerated transportation system for vaccines from the manufacturer to the individual.

COM: Chief of Mission.

Country Team: The senior, in-country U.S. coordinating and supervising body, headed by the Chief of the U.S. diplomatic mission.

CSB: corn-soya blend.

CTC: community therapeutic care.

DART: USAID OFDA Disaster Assistance Response Team.

DASP: OFDA Disaster Assistance Support Program based at the U.S. Department of Agriculture Forest Service.

DCHA: USAID Bureau for Democracy, Conflict, and Humanitarian Assistance.

DCM: Deputy Chief of Mission.

DFID: British Department for International Development.

DOD: Department of Defense.

DP: displaced person. An individual temporarily uprooted from his or her home.

DRM: OFDA Disaster Response and Mitigation Division.

DSM: dry skim milk.

DTP: diphtheria, tetanus, and pertussis.

DWM: dry whole milk.

EAC: Emergency Action Committee. Organization established at a post for the purpose of directing and coordinating the post's response to emergency situations.

EC: European Community.

ECHO: European Community Humanitarian Office.

EDRC: OFDA Emergency Disaster Response Coordinator.

EPI: Expanded Program for Immunization.

epicenter: Point on the Earth's surface directly above the point of origin (focus or hypocenter) of an earthquake.

ETA: estimated time of arrival.

ETD: estimated time of departure.

ETE: estimated time en route.

EU: European Union.

FAA: Foreign Assistance Act of 1961.

FAO: UN Food and Agriculture Organization.

FEMA: U.S. Federal Emergency Management Agency.

FEWSNET: Famine Early Warning Systems Network.

FFP: USAID Office of Food for Peace.

food basket: The particular selection of food commodities that is handled by the assistance operation and included in the rations distributed to the target beneficiaries.

food pipeline: The various location points (port of origin, ship on high seas, port of entry, distribution system) and the amount of food going to an affected population.

FY: fiscal year. October 1 to September 30 for the USG.

GAM: global acute malnutrition.

GMT: Greenwich mean time.

GO_: Three-letter abbreviation for Government of ____; e.g., GOK (Government of Kenya) or GOJ (Government of Japan).

GPS: global positioning system.

GTZ: German Technical Assistance Agency.

HA: humanitarian assistance.

HDR: humanitarian daily ration.

HF: high frequency.

HQ: Headquarters.

hurricane: See tropical cyclone.

IBRD: International Bank for Reconstruction and Development, often referred to as the World Bank.

ICASS: USG International Cooperative Administrative Support Services. Program through which the USG provides and shares the cost of common administrative support at posts overseas.

ICRC: International Committee of the Red Cross.

ICVA: International Council of Voluntary Agencies.

IDA: International Development Association. Part of the World Bank that provides interest-free loans and some grants for programs aimed at boosting economic growth and improving living conditions.

IDP: internally displaced person. A displaced person who is still within the borders of his or her country of origin.

IFRC: International Federation of Red Cross and Red Crescent Societies.

IO: international organization.

IOM: International Organization for Migration.

JICA: Japanese International Cooperation Agency.

MAM: moderate acute malnutrition.

MCH: maternal and child health.

MDRO: U.S. Embassy's Mission Disaster Relief Officer.

MDRP: U.S. Embassy's Mission Disaster Relief Plan.

mitigation: Activities undertaken in advance to limit the adverse impact of disasters.

MOU: memorandum of understanding.

MUAC: mid-upper arm circumference.

NGO: nongovernmental organization. Defined by USAID as any nonprofit or profitmaking organization receiving or providing USAID-funded assistance. General usage of this term in the wider humanitarian community, however, is based on an informal definition that excludes profitmaking organizations and is not limited to organizations associated with USAID. NGO tends to be synonymous with PVO.

OAS: Organization of American States.

OCHA: UN Office for the Coordination of Humanitarian Affairs.

OFAC: Department of Treasury Office of Foreign Assets Control.

OFDA: USAID Office of U.S. Foreign Disaster Assistance.

OFDA/W: USAID Office of U.S. Foreign Disaster Assistance headquarters in Washington, D.C.

OPS: OFDA Operations Division.

ORS: oral rehydration salts.

ORT: oral rehydration therapy.

OSOCC: UN Onsite Operations Coordination Center.

OTI: USAID Office of Transition Initiatives.

PAHO: Pan-American Health Organization.

PEM: protein-energy malnutrition.

PMP: prevention, mitigation, and preparedness.

Post: U.S. Embassy, Consulate, or USAID Mission.

preparedness: Activities undertaken in advance to ensure effective response to the impact of disasters.

prevention: Activities undertaken in advance to absolutely prevent the adverse impact of disasters.

PRM: Department of State Bureau for Population, Refugees, and Migration.

PS: OFDA Program Support Division.

PSC: USG Personal Services Contractor.

pulses: Beans, lentils, and peas.

PVO: private voluntary organization. See also NGO.

RefCoord: Department of State Regional Refugee Coordinator.

Reftel: reference telegram.

refugee: A person who is outside his or her country of origin who, because of a well-founded fear of persecution, is unable to return to that country or to prevail upon that country for protection.

SAM: severe acute malnutrition.

satcom: satellite communications system.

SDCA: Swiss Development and Cooperation Agency.

SDR: Swiss Development and Cooperation Agency (SDCA) Office of Swiss Disaster Relief.

Septel: separate telegram.

SFP: Supplementary Feeding Program.

SIDA: Swedish International Development Agency.

sitrep: situation report.

STI: sexually transmitted infection.

TA: USG travel authorization.

TFC: Therapeutic Feeding Center.

TFP: Therapeutic Feeding Program.

tropical cyclone: An intense tropical weather system of strong thunderstorms with a well-defined surface circulation and maximum sustained winds of 119 km/hr or higher. The term *hurricane* is used for Northern Hemisphere tropical cyclones east of the International Dateline to the Greenwich Meridian. The term *typhoon* is used for Pacific tropical cyclones north of the Equator and west of the International Dateline.

tropical storm: An organized system of strong thunderstorms with a defined surface circulation and wind speeds between 64 and 118 km/hr.

tsunami: A system of sea waves that propagate outward from the source region, formed as a result of a large-scale disturbance over a short period of time. The disturbance can be submarine volcanic eruptions, displacement of submarine sediments, coastal landslides, meteor impact, or earthquakes.

typhoon: See tropical cyclone.

UAC: unaccompanied children.

UHF: ultra high frequency.

UN: United Nations.

UNCHR: UN High Commissioner for Refugees.

UNDAC: UN Disaster Assessment and Coordination Team.

UNDP: UN Development Program.

UNICEF: UN Children's Fund.

UNJLC: UN Joint Logistics Center.

USAID: U.S. Agency for International Development. Also known as AID.

USAR: Urban Search and Rescue.

USD: U.S. dollars.

USG: U.S. Government.

USGS: U.S. Geological Survey.

USPHS: U.S. Public Health Service.

USUN: U.S. Mission to the United Nations.

VHF: very high frequency.

WFP: UN World Food Program.

WHO: UN World Health Organization.

WSB: wheat-soya blend.

Z-Score: Standard deviation above or below the mean.

B. Department of Defense Acronyms and Terms

AC: Active Component of the military.

AFFOR: Air Force forces.

ALCC: Airlift Control Center.

AMC: Air Mobility Command.

AO: Area of Operation.

AOR: Area of Responsibility. The U.S. military divides the world into five geographic areas of responsibility, each supervised by a regional Combatant Commander. See CENTCOM, EUCOM, NORTHCOM, PACOM, and SOUTHCOM.

APC: Armored Personnel Carrier.

ARFOR: Army forces.

ARG: Amphibious Readiness Group.

BDE: Army or Marine Corps Brigade (2,000 to 3,000 personnel).

billet: To quarter or house troops; job assignment or position.

BN: Army or Marine Corps Battalion (600 to 800 personnel).

C-5 (Galaxy): U.S. Air Force's largest cargo aircraft.

C-9: U.S. military aircraft used for medical evacuations.

C-12: U.S. military small aircraft for passengers. Commercial version named King Air.

C-17 (Globemaster III): New generation military cargo aircraft.

C-130 (Hercules): U.S. military turboprop cargo aircraft.

C-141 (Starlifter): U.S. Air Force jet cargo aircraft.

CA: Civil Affairs Units. Part of Special Operation Forces. See SOCOM.

CAG: Marine Civil Affairs Group.

CAP: Crisis Action Planning.

CAT: Crisis Action Team.

CBRNE: Chemical, Biological, Radiological, Nuclear, Explosive.

CC: Combatant Commander. Head of a regional command. See AOR.

CCO: Complex Contingency Operations.

CENTCOM: Central Command. Regional command for South and Central Asia, Horn of Africa, and countries bordering the Arabian Peninsula and the northern Red Sea. Headquartered in Tampa, Florida.

CFST: Coalition Forces Support Team.

CH-47 (Chinook): U.S. Army heavy-lift helicopter.

CH-53A (Sea Stallion): U.S. Navy heavy-lift helicopter.

CIMIC: Civil-Military Cooperation.

CINC: Commander in Chief. President of the United States.

CJTF: Commander, Joint Task Force.

CMO: Civil Military Operations.

CMOC: Civil Military Operations Center.

CMOT: Civil Military Operations Team.

CO: Commanding Officer.

Command Staff designations: **S**=Staff, **G**=General, **J**=Joint.

S/G/J 1 = Administration.

S/G/J 2 = Intelligence.

S/G/J 3 = Operations.

S/G/J 4 = Logistics.

G 5 = Civil Affairs.

J 5 = Plans and Policies.

S-6; G/J 6 = Communications.

J 7 = Transformation.

J 8 = Resources and Assessment.

J 9 = Civil Military Operations (can also be a division under J 5).

CONOPS: Concept of Operations.

CONUS: continental United States; i.e., the 48 contiguous States.

CP: Command Post.

CTF: Combined Task Force.

DAO: Defense Attaché Office.

DATT: Defense Attaché.

DIV: Army or Marine Corps Division (8,000 to 12,000 personnel).

DSN: Defense Switching Network. DOD telephone system.

echelon: Subdivision of a headquarters.

EUCOM: European Command. Regional command for Europe, Africa (except for the Horn of Africa), Mediterranean Sea, and bordering countries. Headquartered in Stuttgart, Germany.

FAO: Foreign Area Officer.

FHA: Foreign Humanitarian Assistance.

FPA: Foreign Policy Advisor. See POLAD.

FUNCLAN: Plans involving military operations in a peacetime or permissive environment, developed to address requirements such as humanitarian relief.

General Orders: Permanent instructions, usually concerning matters of policy or administration.

H-3 (Sea King): U.S. military medium-lift helicopter.

HACC: Humanitarian Assistance Coordination Center.

HAP: Humanitarian Assistance Program.

HAST: Humanitarian Assistance Survey Team.

HMMWV: Highly Mobile Multipurpose Wheeled Vehicle. Humvee. Successor to the Jeep.

HOC: Humanitarian Operations Center.

HRO: Humanitarian Relief Operations. Also referred to as HUMRO.

HUMINT: Human Intelligence.

JCMOTF: Joint Civil Military Operations Task Force.

JCS: Joint Chiefs of Staff.

JFC: Joint Force Commander.

JFCOM: Joint Forces Command.

JIB: Joint Information Bureau. Focal point for the interface between the military and the media.

JMC: Joint Movement Center. Coordinates transportation of all operational assets. Also referred to as Joint Movement Control Center (JMCC).

JOA: Joint Operations Area.

JOPEs: Joint Operations Planning and Execution System.

JPOTF: Joint Psychological Operations Task Force.

JSOTF: Joint Special Operations Task Force.

JTF: Joint Task Force.

LNO: Liaison Officer.

LOC: Line of Communication.

LOGCAP: Logistics Civilian Augmentation Program.

MARFOR: Marine Force.

MEF: Marine Expeditionary Force.

METL: Mission Essential Task/Training List.

METT-T: Mission Enemy Terrain Troops-Time.

MEU: Marine Expeditionary Unit.

MLO: Military Liaison Officer. DOD representative at U.S. Embassy.

MNF: Multinational Force.

MOOTW: Military Operations Other Than War.

MPF: Marine prepositioned force.

MPS: Marine prepositioned ship.

MRE: meal, ready-to-eat. Complete individual combat meal in a pouch.

NAVFOR: Navy forces.

NCA: National Command Authority. The President and the Secretary of Defense, or their authorized alternates or successors.

NEO: Noncombatant Evacuation Operation.

NORTHCOM: Northern Command. Regional command for North America, including Mexico and Canada, and the western half of the Atlantic Ocean, including Cuba and the Bahamas, but excluding the rest of the Caribbean. Headquartered in Colorado Springs, Colorado.

OCONUS: Outside the continental United States. See also CONUS.

OH-58 (Kiowa): U.S. Army light helicopter.

OHDACA: Overseas Humanitarian, Disaster, and Civic Aid. DOD funding authority for humanitarian assistance programs.

OOTW: operations other than war.

OPCOM: Operational Command.

OPCON: Operational Control.

OPLAN: Operations Plan.

OPORD: Operations Order.

OPS: Operations.

OPSEC: Operational Security.

OSD: Office of the Secretary of Defense.

PACOM: Pacific Command. Regional command for the Pacific Ocean, part of the Indian Ocean, and East and Southeast Asia. Headquartered in Honolulu, Hawaii.

PDD: Presidential Decision Directive.

PDD 25: Presidential policy on reforming multinational peace operations.

PDD 39: Presidential policy on response to CBRNE terrorism acts.

PDD 62: Expands on PDD 39.

POLAD: Political Advisor.

POTUS: President of the United States.

PSYOPS: Psychological Operations.

RC: Reserve Component of the military.

ROE: rules of engagement. Defines when and how force may be used.

RORO: Roll-on/ roll-off. Type of transport ship.

SECDEF: Secretary of Defense.

SF: U.S. Army Special Forces.

SJA: Staff Judge Advocate.

SOCOM: Special Operations Command. Functional command for unconventional forces worldwide, including elite strike forces, psychological operations, and civil affairs units. Headquartered in Tampa, Florida.

SOF: Special Operations Forces.

SOFA: Status of Forces Agreement.

SOUTHCOM: Southern Command. Regional command for Latin America land area and the Caribbean. Headquartered in Miami, Florida.

SSC: small-scale contingencies.

TACOM: Tactical Command.

TACON: Tactical Control.

TALCE: Tanker Airlift Control Element.

TDY: temporary duty.

TF: Task Force.

Theater: Region of the world for which a Combatant Commander has responsibility for U.S. military operations.

TPFDD: time-phased force deployment data.

TRANSCOM: Transportation Command Functional command for all surface/air/sealift. Headquartered at Scott Air Force Base, Illinois.

UH-1H (Huey): U.S. military medium capacity helicopter.

UH-60 (Blackhawk): U.S. military medium capacity helicopter.

WMD: weapons of mass destruction.

WWMCCS: World Wide Military Command and Control System.

Zulu: Greenwich mean time. See GMT in section A.

Appendixes

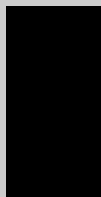

Appendix A

Field Situation Reporting Format

FIELD SITUATION REPORTING FORMAT

This sample identifies the basic information needed by the U.S. Agency for International Development (USAID) Office of U.S. Foreign Disaster Assistance in Washington, DC, (OFDA/W) or the Response Management Team for use in assisting and supporting the Disaster Assistance Response Team (DART) and for assembling the OFDA/W situation report (sitrep) product. Each disaster will dictate additional information to be included in the field sitrep cable. Items to include are as follows.

1. DART field location, including city and country, and date

Sitrep Number.

Date.

2. Disaster data, including the sources of the information

- Number affected.
- Number of dead.
- Number of displaced.
- Number of injured.
- Crude mortality rate (measured in deaths per 10,000 people per day).
- Global acute malnutrition (GAM).
- Severe acute malnutrition (SAM).
- Availability of food and water.
- Epidemics.
- Number vaccinated.
- Location of displaced camps.
- Extent of damage (buildings damaged and destroyed, areas of flooding, amount of damage to roads and bridges, areas of drought, areas of civil strife, etc.).
- Water supply and sanitation conditions.
- Status of transportation systems for emergency response.
- Short narrative on the overall situation.

3. Issues (political and others) arising or needing resolution and DART recommendations

4. DART activities since last report (sample types of information to report)

- Number of DART members and their locations. (Note: At times, this information may be sensitive and should be treated appropriately.)
- Assessment of activities by function or sector.
- Accomplishments by function or sector (persons assisted, meetings attended, commodities received from OFDA stockpile or other shipments of U.S. Government [USG] donations, commodities distributed).
- Estimated cost expended to date directly by the DART.
- Coordination with other USG responders (USAID Mission, U.S. Embassy, Department of Defense).

5. Activities of others

- Affected country.
- Other donor countries.
- United Nations, private voluntary organizations, nongovernmental organizations, and international organizations.

6. Actions requested of OFDA/W

- Requests for personnel, equipment, supplies for DART.
- Requests for relief commodities.
- Status of previous requests (reference sitrep number).
- Requests for information.
- Answers to or status of issues raised previously (reference sitrep number).

Appendix B

OFDA Stockpile Commodities and DART Support Equipment

OFDA STOCKPILE COMMODITIES AND DART SUPPORT EQUIPMENT

A. Introduction

U.S. Agency for International Development (USAID) Office of U.S. Foreign Disaster Assistance (OFDA) maintains stockpiles of standard relief commodities at strategic locations around the world. The purpose of these stockpiles is to position relief commodities closer to potential disaster sites to make relief commodities more immediately available to disaster victims. The prepositioning of these commodities also reduces the delivery costs.

To access commodities in the stockpiles, the OFDA Logistics Officer notifies the stockpile managers of the types and amounts of items needed for a disaster and coordinates the pickup and delivery of the commodities to the affected country. The types and amounts of commodities withdrawn from the stockpiles are based on the acceptance of needs assessments conveyed to OFDA from the affected country.

The initial stockpile commodities released to a disaster may precede the arrival of a USAID Disaster Assistance Response Team (DART). On arrival at a disaster site, DART members should be prepared to assist in or take on the responsibility of locating or receiving, offloading, inventorying, issuing, tracking, and accounting for these commodities. If at any time during a disaster the DART needs further stockpile commodities, a request with a description of the need must be processed through OFDA. A DART cannot access the stockpiles directly.

Stockpile commodities may be released to the United Nations, private voluntary organizations, nongovernmental organizations, and/or international organizations that are qualified to distribute and instruct in the use of the commodities.

OFDA in Washington (OFDA/W) Logistics is constantly reviewing the usefulness, quality, and feasibility of stockpile commodities and DART support equipment. OFDA/W Logistics also looks for new items for relief commodities and team support. Therefore, OFDA may have commodities or support equipment available that are not listed below. For example, OFDA now owns a variety of vehicles for DART use. These vehicles have a range of capabilities including gas or diesel, left- or right-hand drive, armored or unarmored. If you have a need for a specific commodity or support equipment, contact OFDA/W Logistics, and they may be able to assist you.

Information critical to the planning of all aspects of the ordering, movement, tracking, and accounting of OFDA stockpile commodities and DART support equipment is provided below in section B. This section also contains detailed information about obtaining and using plastic sheeting to construct temporary shelters.

B. Relief Commodities

The following items are standard relief commodities that OFDA stockpiles. OFDA may at times stockpile small quantities of other items, including medical kits, soap, or hard hats. OFDA/W Logistics is able to quickly procure a wide variety of items, such as kitchen sets, tents, face masks, or gloves, and deliver them within a few days of a request.

1. Blankets

Wool blankets are usually packaged in bales of 25 each. A bale weighs 73 pounds, measures 22 by 28 by 31 in, and displaces 11.1 ft³. Check with the Logistics Officer, however, because some manufacturers may package them differently.

2. Water Containers, 10-Liter Collapsible

Water containers are for use by disaster victims and relief workers for moving and storing potable water. Each box holds 50 water containers, and each skid has 12 boxes. Skid dimensions are 48 by 40 by 50 in, with each skid displacing 56 ft³ and weighing 290 lb.

3. Hygiene Kits

The hygiene kit is intended to supply disaster victims with basic hygienic commodities. Each unit is packaged in a corrugated box that contains supplies sufficient for a family unit of five for about 2 weeks. Each box contains six hygiene kits, and each skid holds 30 boxes. Skid dimensions are 48 1/2 by 30 by 85 in. Each skid displaces 72 ft³ and weighs 1,150 lb. Hygiene kits include the items shown in table B-1.

Table B-1. Hygiene Kit Contents

Item	Description/Size	Quantity
Comb	7-inch plastic	1 each
Detergent washing powder	25 oz	1 package
Razor, disposable twin blade	5-count pack	1 pack
Sanitary napkins	12 count per bag	1 bag
Shampoo	8-oz bottle	2 each
Soap bar	3-oz size	2 each
Soap dish—plastic, closed type	Hinged lid	1 each
Toilet paper	500-count sheets	2 rolls
Toothbrush, nylon bristle	30-tuft	5 each
Toothpaste	2.5 oz	1 tube

4. Water Bladder Kit, 10,000-Liter

These water bladders are made from polyester coated with polyvinyl chloride (PVC) and are suitable for drinking water storage. The bladder is totally sealed and lies flat on the ground like a pillow. It comes in a wooden crate with 12 outlet taps, tools for setup and repair, and 30 ft of semirigid water pipe. The box measures 37 by 42 by 42 in, weighs 450 lb, and displaces 37.8 ft³.

5. Water Treatment Units

Each unit is mounted on a trailer designed for offroad application, and can be towed by a four wheel drive vehicle. The unit provides pumping, purification, storage, and distribution. It consists of a diesel-driven centrifugal pump, a sand filter, a chlorine dosing unit, a 40 m³ capacity water storage steel tank, and six water station kits with piping. The unit can fulfill the daily water requirement of 10,000 people. Included is a tool kit; extra air filters; a kit for chlorine, pH, and turbidity analyses; and a supply of consumables. The unit, including the nondetachable trailer hitch, measures 128 by 84 by 83 in, weighs 4,520 lb, and displaces 516 ft³.

6. Plastic Sheeting

a. General

This sheeting is specially designed for shelter and can be used to replace damaged or destroyed walls or roofing or to construct temporary shelter for people in need. Because of

its high cost and unique qualities, the sheeting should be used only to meet temporary human shelter requirements. This plastic sheeting should last more than 1 year under normal field conditions; it functions extremely well in hot climates. It can be used to:

- Repair holes in a damaged wall.
- Cover holes in a damaged roof.
- Cover a roof on an existing structure.
- Cover the walls and/or roof of a newly constructed structure.
- Construct personal temporary shelters.

It can also be used to repair or build a large structure, such as a school, field hospital, or other community-type structure. The sheeting can be divided into smaller pieces and distributed according to local needs and conditions.

b. Description

The plastic sheeting (24 by 100 ft) is boxed one roll per box and weighs 120 lb (54.4 kg). Each box is 42 by 24 by 16 in (1.1 by 0.6 by 0.4 m). Figure B-1 shows an example of the dimensions of the plastic sheeting. Each skid contains 10 boxes and measures 48 by 42 by 83 in (1.2 by 1.1 by 2.1 m). The weight of a 10-box skid is about 1,275 lb (578 kg). The volume of a skid is 97 ft³ (2.8 m³).

Figure B-1. Plastic Sheeting Dimensions

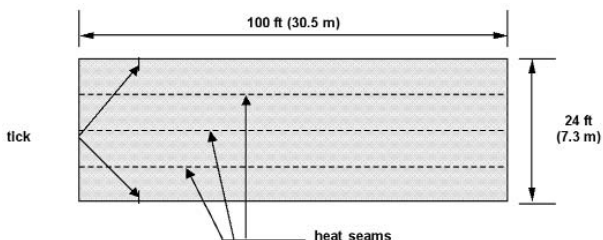

The plastic is nontransparent and coated on both sides with a black scrim net that makes it strong; tearproof. The white side is ultraviolet-deflective; the other side is beige. It absorbs heat from the sun in colder climates. An 8-in (20.3-cm) USAID emblem is printed on the plastic at 6-ft (1.8-m) intervals. It has heat-sealed seams 6 ft apart along the length of the roll. These seams allow for quick separation because they easily tear apart.

Both sides have tick marks at 10-ft (3.0-m) intervals for measuring purposes. Also enclosed are six rolls of adhesive tape constructed from the same material as the plastic. Each roll of tape is 30 ft (9.1 m) long and 1 3/4 in (4.4 cm) wide.

Special care must be taken when heating the shelter; although the material is fire-retardant, open fires should not be allowed in or near the shelter because plastic sheeting will burn.

Moisture will condense (sweat) inside when the plastic is made into enclosed tent-like shelters and used in high altitudes or cold climates; the sheeting is nonporous and does not breathe. To remedy this, use a second layer of plastic over the structure; keep this second layer from touching the frame of the structure.

c. *Distribution*

Before unpacking and unrolling the sheeting, move the distribution operation to a large area such as a school gym, football field, or airport hanger that preferably is protected from the weather. For distribution purposes, the sheets can easily be separated at the heat seams by peeling the seams apart. Normally a single sheet is split at the center seam, which allows strips of 12 by 100 ft (3.7 by 30.5 m). These strips are then cut to the appropriate lengths for distribution.

With the measuring marks at every 10 ft (3.0 m), cutting lines can be quickly established. The most common size for a small family is a 12 by 20 ft piece (3.7 by 6.1 m). This size may be enlarged according to family size, weather conditions, and other considerations, such as the need for roofing patches or replacements.

d. *How To Use Plastic Sheeting*

To create an enclosed, private living space in or contiguous to a damaged or undamaged structure, plastic sheeting can

be stretched over a portion of the structure and anchored to the ground with ropes and stakes like a tent in several ways, or attached to the structure to create additional covered space contiguous to the structure.

- Wrap the ends of the plastic that will be staked down around a stick. Poke holes in the plastic along the stick and tie ropes around the stick. Then, stake the ropes.
- Place a small rock under the sheeting. Twist the sheeting around the rock. Tie a rope around the twisted sheeting. Then, stake the rope.
- Use as many stakes or anchors as needed to keep the plastic as tight as possible.
- Stretch the sheeting over a damaged structure, and nail it to the remaining portions of the structure.
- Stretch the sheeting over the roof or roof segment. Pull the plastic sheeting as tight as possible before connecting it to the roof frame. To get the sheeting tight, pull it firmly in all four directions.
- Be sure to stretch the plastic tight and attach it securely to the roof frame or anchor it to the ground.
- Hammer the nails through some type of washer, such as a piece of tire, rubber, or a flattened bottle cap. Or, hammer the nail through a batten.

When no structures are available to create covered living space in combination with plastic sheeting, or when using existing structures as part of a shelter solution might expose beneficiaries to additional risks (e.g., earthquake-, flood-, or conflict-damaged walls may not be structurally sound), framing material, such as wood, metal, or plastic poles, bush sticks, tree branches, and/or rope/string, may have to be provided to enable beneficiaries to erect a basic, free-standing shelter. Examples of this form of shelter appear in figure B-2. Most of the guidelines on sheeting use noted above are also relevant for these free-standing structures. Sheeting could be supplemented with mats, blankets, or other materials suitable for enclosing space.

Figure B-2. Examples of Plastic Sheeting Shelters

Key A = Area m = meter p = person

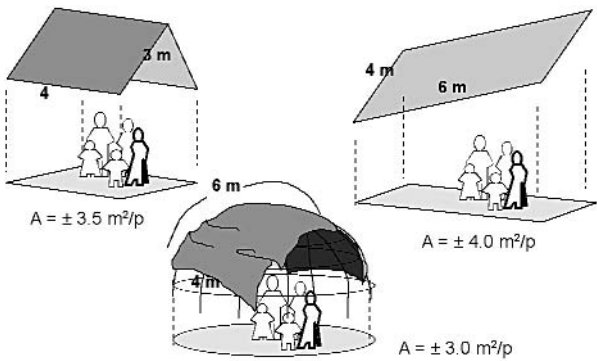

Note: Use of standard, 4 by 6 m piece of sheeting depends on context, climate, tradition, and other factors. The Sphere Project indicator is for “covered living space,” not square meters of plastic sheeting.

(1) Hot Weather Conditions

- Turn the white side of the sheeting toward the outside to reflect as much of the sun’s heat as possible.
- Make the roof of any new structure as high as possible.
- Vent the roof to let super-hot air escape and reduce the temperature inside the structure. Ventilation through doors and windows helps, but not enough.

(2) Cold Weather Conditions

- Turn the long side of the structure toward the warmth of the sun. Then, turn the dark (beige) side of the sheeting toward the outside to absorb more heat.
- Make the roof of any new structure as low as possible.
- Shovel dirt or even snow against the outside of the structure walls to help hold the heat inside.

- Fasten a second layer of plastic sheeting or any other material on the inside to create a double layer for insulation.

(3) Precautions

- During windy weather, loose sheeting will flap violently and cause (more) damage to the structure.
- During rainy weather, loose sheeting will collect rainwater, which can cause (more) damage to the structure.
- After a strong wind or rainstorm, look at the structure for signs of wear and tear. Tighten all ropes and use additional nails, if needed, to tighten the sheeting.

C. DART Support Supplies and Equipment

OFDA stocks a variety of supplies and equipment to support DART and Assessment Team members, such as field packs, remote location kits, vests, helmets, and office supply kits. OFDA also maintains a fleet of fully-armored, lightly-armored, and unarmored vehicles for field operations. Other supplies and equipment can be obtained through interagency agreements with agencies such as the U.S. Department of Agriculture Forest Service and the Fairfax County, Virginia, and Los Angeles, California, Fire Departments. Descriptions of the field packs, remote location kits, and office supply kits are provided below; contact the Logistics staff for information about other supplies.

1. OFDA Field Packs

The purpose of the OFDA field pack is to provide the necessary items to allow OFDA personnel sent to the field to be able to support themselves for 48 to 72 hours under adverse field conditions if necessary. Many items are useful to an individual during a relief operation. Remember that a field pack is a support kit, not a survival kit, and is not intended to complement personal items that DART members bring on a deployment. Each pack measures 18 by 18 by 12 in, displaces 2.3 ft³, and weighs 23 lb. Table B-2 lists the contents of the field pack. All items are consumable, except for the pack itself, which must be returned to OFDA/W Logistics.

2. Remote Location Kits

Remote location kits are issued to OFDA personnel being dispatched to locations where food, potable water, lodging, and

other comfort items may be limited, delayed, or nonexistent. The kit contains the OFDA field pack in its entirety plus larger items such as a sleeping bag and ground pad, water filter, and tent. As with the field pack, the remote location kit is intended to provide limited support in the field and is not a survival kit. Most of the remote location kit items are durable and must be returned to OFDA/W Logistics.

Table B-2 lists the items contained in the field pack and remote location kits and identifies whether the item is durable or consumable.

Table B-2. OFDA Field Pack and Remote Location Kit Contents

Item Description	Qty	Durable vs. Consumable
Field Pack Contents		
Backpack, Kelty Redwing	1	Durable
Bag, plastic (Ziploc)	10	Consumable
Bag, trash	5	Consumable
Bandana (cotton)	1	Consumable
Blanket, emergency (space)	2	Consumable
Bottle, water, w/push-pull cap	2	Consumable
Bowl, plastic, w/lid	1	Consumable
Candles, dripless	12	Consumable
Candle lantern	1	Consumable
Compass, azimuth, w/mirror	1	Consumable
Cord, parachute, 100 ft, 550 lb test	1	Consumable
Cup, stainless	1	Consumable
Ear plugs, w/case	2	Consumable
Eye wash	1	Consumable
First aid kit, individual	1	Consumable
First aid manual, individual	1	Consumable
Flagging, 150 ft, Day-Glo pink	1	Consumable
Flashlight, Mini Maglite w/case	1	Consumable
Flashlight bulbs (2 per pack)	1	Consumable
Flashlight headband	1	Consumable

Table B-2. OFDA Field Pack and Remote Location Kit Contents (continued)

Item Description	Qty	Durable vs. Consumable
<i>Field Operations Guide</i>	1	Consumable
Gloves, latex	5	Consumable
Handiwipes, germicidal	50	Consumable
Insect bite swab, Sting-Kill	1	Consumable
Insect repellent, lotion	2	Consumable
Mask, dust	5	Consumable
Matches, waterproof	4	Consumable
Meal, MRE	8	Consumable
Mirror, heavy duty	1	Consumable
Net, mosquito	1	Consumable
Sunscreen, SPF 30 or higher	1	Consumable
Tape, fiberglass	1	Consumable
Tool, survival (pliers head, knife)	1	Consumable
Towel, cotton	1	Consumable
USAID patch, with Velcro®	2	Consumable
Utensil kit	1	Consumable
Water purification tablets	1	Consumable
Additional Remote Location Kit Contents		
Dromedary bag, water	1	Consumable
Dromedary hydration kit	1	Durable
Duffel bag, rolling	1	Durable
Jacket, rain	1	Consumable
Mattress/ground pad, 3/4 inch with stuff sack	1	Durable
Pants, rain	1	Consumable
Sleeping bag, to 20° F	1	Durable
Sleeping bag liner	1	Durable
Tent, 60 second	1	Durable
Water filter, MSR MiniWorks	1	Durable

Appendix C

Aircraft Use and Capability and Ocean and Overland Transport

AIRCRAFT USE AND CAPABILITY AND OCEAN AND OVERLAND TRANSPORT

A. Aircraft Information

U.S. Agency for International Development (USAID) Office of U.S. Foreign Disaster Assistance (OFDA) frequently uses aircraft to support disaster response activities. It may use commercial aircraft or Department of Defense (DOD) aircraft. OFDA must first check the availability of commercial air carriers to meet disaster response needs. If commercial aircraft are available, they are chartered by OFDA Washington (OFDA/W) Logistics through USAID Office of Transportation. Because licenses may be required to charter commercial aircraft, check with OFDA/W Logistics first.

If commercial aircraft are not available, OFDA may request assistance from DOD. If DOD approves the request, OFDA will work directly with the Joint Chiefs of Staff's (J4) Logistics Readiness Center to work out the details on needs, availability, timeframes, and accountability. Be advised that any time DOD aircraft are used, OFDA must follow all DOD regulations on weights, cubes, manifesting, hazardous cargo, and takeoff and landings. If more information is needed on DOD regulations or restrictions, contact the OFDA's Logistics Officer.

When loading and offloading any type of aircraft, the pilot or the crew chief is in charge, and will make the final determination on a "go/no-go" for the flight based on the load, weather conditions, runway conditions, and any conditions specific to the flight.

Always consider safety around aircraft. Follow the instructions of the pilot or crew chief.

B. Points To Consider When Dealing With Aircraft

- Whenever possible, store all materials to be airlifted in containers (e.g., suitcases, backpacks, and metal and cardboard boxes) for rapid handling and stacking on pallets.
- Ensure that all individual containers must be small enough to fit through passenger doors of commercial aircraft in case cargo space is not available.
- Package personal gear (e.g., in a pack or suitcase) with the owner's name clearly marked for rapid customs processing.

- Mark packages containing hazardous materials or chemicals and separate them from all other cargo so they can be left behind if they are refused by the carrier.
- Ensure that individual pieces of cargo do not weigh more than 200 lb to enable pieces to be moved by two people. Each DART member is responsible for his or her personal luggage.
- Consider the following factors when determining the fuel requirements and, thus, the cargo capacity of the aircraft (the more fuel required, the less weight available for cargo):
 - Length of the flight.
 - Availability of fuel en route to destination.
 - Availability of fuel at or near final destination for the return trip.
- Follow crew duty day and flight times. Aircraft at your disposal are not an unlimited resource.

Crew duty day refers to the maximum amount of time that a flight crew can be engaged in standing by for a flight or actually flying in an aircraft. The normal crew duty day is 15 hours of combined standby/flying time. Crew flight time refers to the maximum amount of time a flight crew can spend physically flying or maintaining an aircraft.

Sometimes certain preflight and postflight aircraft activities are included in crew flight time duty; verify this with the flight crew in advance. For your planning purposes, find out the flight crew's duty day and flight times.

C. Aircraft Loading and Offloading Methods

Aircraft can be loaded in four ways.

- **Bulk-loaded:** Cargo is loaded on the floor and held in place by nets, straps, or ropes.

Bulk loading may increase the usable cargo space on an aircraft; however, securing cargo in place may be more difficult than palletizing. Depending on the offloading equipment at the destination airport, bulk loading may be the best loading option. Bulkloading aircraft is normally seen on Russian cargo planes, such as the IL-76 and AN-12.

- **Palletized:** Cargo is preloaded onto pallets; held in place by nets, straps, or ropes; and then loaded onto the aircraft.

Palletizing cargo is a frequently used method of moving OFDA commodities. Military and commercial aircraft can use pallets. Military pallets, officially called dual rail 463L pallets (nicknamed “cookie sheets”), measure 88 by 108 in, are made of aluminum, and weigh 356 lb. The loaded pallets can range in weight from 2,000 to 6,000 lb. These pallets are reusable and must be returned. Do not leave them at the unloading site. Pallets are used on C-5s, C-17s, C-141s, C-130s, and some commercial aircraft. For logistical planning purposes, when building pallets, limit the height of a pallet to 96 in for these aircraft unless authorized by the crew chief to stack higher.

The size of commercial pallets varies, but the most common sizes are 88 by 108 in or 88 by 125 in. Commercial pallets are used on DC-8s, B-727s, DC-10s, and B-747s and weigh approximately 231 lb. These pallets are also reusable. Commercial Hercules aircraft (C-140s) also use an 88 by 118 in pallet.

- **Containerized:** Cargo is preloaded into closed containers, and then loaded onto the aircraft.

Containerizing cargo is a method used to load the belly of commercial aircraft, such as 747s and DC-10s. Cargo containers come in a variety of shapes and sizes, and the maximum loaded weights for containers used on aircraft can range from 200 to 10,000 lb. Each type of container is designed to be loaded and offloaded with cargo in place using a mechanized loading system or a forklift.

If a forklift will be used to load or offload containers or pallets, make sure that the forklift can carry the largest pallet, has tines long enough to counterbalance the weight, and that the highest point of the forklift is lower than that portion of the aircraft (wing, tail, or door in open position) where it must move to retrieve the container or pallet.

- **External (helicopters only):** Cargo is placed in a net or suspended from a line, and then picked up and moved by the helicopter using a belly hook.

External (sling) loading of cargo is performed with helicopters. Helicopters normally can lift and move less cargo externally than internally. The external cargo is loaded into specially made nets that are connected to a cargo hook on the belly of the helicopter. Cargo may also be suspended on cables

(leadlines). Make sure that leadlines and nets are approved for slinging cargo.

Remember that pallets, containers, nets, and leadlines are reusable and may also need to be returned quickly to their points of origin to be used for loading more cargo. Always think in terms of “backhauling” cargo equipment for reuse or when no longer needed.

D. Points To Consider When Planning To Receive Aircraft Cargo

- Ramp space for parking the aircraft. If no ramp space is available and the cargo will have to be unloaded on the active runway, consider offloading time and the schedules of other aircraft arrivals.
- The weight of the loaded aircraft and the ability of the ramp to support parked aircraft.
- Availability of trucks and laborers if the aircraft will be manually offloaded. Remember, planes may arrive at all hours.
- Availability of correctly sized offloading equipment (e.g., K loader or forklift) if the aircraft will be offloaded using offloading equipment. Think again about arrival times. If offloading equipment is not available and a DOD aircraft is being used, OFDA Logistics may be able to get approval from DOD for the Air Force to bring along a forklift on the arriving aircraft. The amount of relief commodities that will fit on the aircraft, however, may be reduced.
- Storage space near the ramp if the commodities will be stored close to the offloading point. Consider whether the location of the storage area will cause security problems.

Tables C-1 and C-2 list some types of fixed- and rotary-wing aircraft that have been or might be used by OFDA during disaster operations. The tables include specifications for the different categories of aircraft. The purpose of these tables is to assist in planning for the movement of people and commodities. Note, however, that these figures represent approximate aircraft specifications. Specifications for each aircraft will vary based on individual aircraft configurations and ratings, operating range, runway conditions, temperature, altitude, wind speed, and direction. Always check with local aviation authorities about which types of aircraft can operate in and out of local airports.

These tables do not include specifications for aircraft capable of spraying insecticides. These specifications are available through the OFDA Logistics Officer.

Table C-1. Capacities of Aircraft Freighters

Aircraft Type	Maximum Cargo Weight Metric Tons (2,200 lb)	Cargo Hold Size L x W x H (cm)	Door Size W x H (cm)	Usable Cargo Volume (m ³)	Pallet Qty. 224 x 318 (cm)	Desired Runway Length (ft)
Most Often Used						
AN-12	15	1,300 x 350 x 250	310 x 240	100	n/a	n/a
AN-26	5.5	1,060 x 230 x 170	200 x 160	50	n/a	n/a
AN-124	120	3,300 x 640 x 440	600 x 740	850	n/a	10,000
B707-320C	43	2,900 x 330 x 210	340 x 230	160	13	8,000
B727-100F	16	2,000 x 350 x 210	340 x 220	112	9	7,000
B727-200F	21	2,700 x 350 x 210	340 x 220	150	12	8,300
B747-200F	109	5,100 x 500 x 300	340 x 310	525	37	10,700
B747-400F	113	5,100 x 500 x 300	340 x 310	535	37	n/a
DC-8 55AF	43	3,000 x 330 x 210	350 x 220	150	13	8,000
DC-8 62AF	43	3,200 x 330 x 210	350 x 220	160	14	8,000
DC-8 73AF	51	4,100 x 330 x 210	350 x 220	210	18	8,000
DC-10 10F	56	4,100 x 450 x 250	350 x 260	380	23	8,000
DC-10 30F	70	4,100 x 450 x 250	350 x 260	380	23	8,000

Note: The cargo capacities and cruise speeds listed in the table are averages for that type of aircraft. Actual capacities will vary based on the altitude, ambient air temperature, and actual fuel on board.

Table C-1. Capacities of Aircraft Freighters (continued)

Aircraft Type	Maximum Cargo Weight Metric Tons (2,200 lb)	Cargo Hold Size L x W x H (cm)	Door Size W x H (cm)	Usable Cargo Volume (m ³)	Pallet Qty. 224 x 318 (cm)	Desired Runway Length (ft)
IL-76	40	2,500 x 330 x 340	330 x 550	180	n/a	2,800
MD-11F	90	3,800 x 500 x 250	350 x 260	365	26	n/a
Other Craft Used						
A300F4-100	40	3,300 x 450 x 250	360 x 260	320	20	8,200
A300F4-200	42	3,300 x 450 x 250	360 x 260	320	20	8,200
A310-200F	38	2,600 x 450 x 250	360 x 260	260	16	6,700
A310-300F	39	2,600 x 450 x 250	360 x 260	260	16	6,700
AN-22	60	3,300 x 440 x 440	300 x 390	630	n/a	n/a
AN-32	6.7	1,000 x 250 x 110	240 x 120	30	n/a	n/a
AN-72/74	10	1,000 x 210 x 220	240 x 150	45	n/a	n/a
B737-200F	12	1,800 x 330 x 190	350 x 210	90	7	7,000
B737-300F	16	1,800 x 330 x 210	350 x 230	90	8	7,000
B747-100F	99	5,100 x 500 x 300	340 x 310	525	37	9,000
B757-200F	39	3,400 x 330 x 210	340 x 220	190	15	5,800
B767-300F	55	3,900 x 330 x 240	340 x 260	300	17	6,500
BAe 146 100QT	7.5	1,600 x 280 x 180	330 x 190	65	6	4,200

Table C-1. Capacities of Aircraft Freighters (continued)

Aircraft Type	Maximum Cargo Weight Metric Tons (2,200 lb)	Cargo Hold Size L x W x H (cm)	Door Size W x H (cm)	Usable Cargo Volume (m ³)	Pallet Qty. 224 x 318 (cm)	Desired Runway Length (ft)
BAe 146 200QT	9.5	1,600 x 280 x 180	330 x 190	65	6	4,700
BAe 146 300QT	10	1,800 x 280 x 180	330 x 190	75	7	n/a
BAe HS-748	5.1	1,100 x 250 x 190	270 x 170	55	n/a	n/a
Banderante	1.5	950 x 160 x 160	180 x 140	15	n/a	n/a
Beech 99	1.2	580 x 120 x 120	120 x 130	8	n/a	n/a
Cessna 406	1.5	460 x 140 x 130	125 x 125	8	n/a	n/a
Cessna Caravan	1.5	360 x 160 x 130	120 x 130	7	n/a	n/a
Corvair CV-580	7.2	1,600 x 250 x 170	310 x 230	68	n/a	n/a
DC-3	3.5	1,000 x 200 x 175	215 x 150	30	n/a	4,300
DC-6	13	1,585 x 315 x 220	315 x 200	100	n/a	6,000
DC-9 10F	10	1,800 x 275 x 190	340 x 200	70	6	6,000
DC-9 33F	17	2,100 x 275 x 190	340 x 200	90	8	5,500
F-27	5.9	1,300 x 240 x 180	230 x 180	45	n/a	4,200
Fairchild Metro III	2.2	500 x 150 x 130	65 x 45	10	n/a	n/a
HS 748	6.0	1,090 x 135 x 190	170 x 265	55	n/a	n/a
King Air 350	1.2	590 x 140 x 140	120 x 160	10	n/a	n/a

Table C-1. Capacities of Aircraft Freighters (continued)

Aircraft Type	Maximum Cargo Weight Metric Tons (2,200 lb)	Cargo Hold Size L x W x H (cm)	Door Size W x H (cm)	Usable Cargo Volume (m ³)	Pallet Qty. 224 x 318 (cm)	Desired Runway Length (ft)
L-100	22	1,780 x 310 x 260	300 x 280	120	6	n/a
L-100-20	20	1,780 x 310 x 260	300 x 280	120	6	n/a
L-100-30	23	1,780 x 310 x 260	300 x 280	120	6	n/a
L-1011 1F	49	4,100 x 460 x 290	400 x 300	296	23	7,400
L-1011 200F	54	4,100 x 460 x 290	400 x 300	296	23	7,400
L-188 Electra	15	2,000 x 300 x 190	350 x 200	80	6	n/a
LET-410	1.6	500 x 150 x 160	145 x 120	11	n/a	n/a
SD 360	3.5	1,000 x 190 x 185	165 x 140	35	n/a	n/a
SD 380	2.7	940 x 190 x 190	165 x 140	28	n/a	n/a
Shorts Belfast	34	1,900 x 360 x 360	400 x 400	250	n/a	n/a
Shorts SD-330-200	3.3	900 x 190 x 190	140 x 170	28	n/a	n/a
Trislander	1.5	800 x 110 x 125	120 x 110	9	n/a	n/a

Table C-2. Types of Helicopters That OFDA Typically Uses During Disaster Operations

Helicopter Type	Fuel Type	Cruising Speed (knots)	Typical Allowable Payload for Hovering In Ground Effect* (kg/lb)	Typical Allowable Payload for Hovering Out of Ground Effect (kg/lb)†	Number of Passenger Seats
Most Often Used					
MI-8	Jet	110	3,000/6,600	3,000/6,600	20–30
Boeing H 47 Chinook	Jet	130	12,210/26,918	12,210/26,918	33
Bell 205 A-1	Jet	90	635/1,400	635/1,400	14
Bell 206L Long Ranger	Jet	110	522/1,150	431/950	6
Bell 412 Huey	Jet	110	862/1,900	862/1,900	13
Sikorsky S-70 (UH-60) Black Hawk	Jet	145	2,404/5,300	1,814/4,000	14–17
Other Helicopters Used					
Aerospatiale SA-315B Lama	Jet	80	420/925	420/925	4
Aerospatiale SA-316B Allouette III	Jet	80	526/1,160	479/1,055	6
Aerospatiale SA-318C Allouette II	Jet	95	420/926	256/564	4
Aerospatiale AS-332L Super Puma	Jet	120	2,177/4,800	1,769/3,900	26
Bell G-47 Aviation	Gas	66	272/600	227/500	1
Bell 47 Soloy	Jet	75	354/780	318/700	2
Bell 204B	Jet	120	599/1,200	417/920	11

Table C-2. Types of Helicopters That OFDA Typically Uses During Disaster Operations (continued)

Helicopter Type	Fuel Type	Cruising Speed (knots)	Typical Allowable Payload for Hovering In Ground Effect* (kg/lb)	Typical Allowable Payload for Hovering Out of Ground Effect (kg/lb)†	Number of Passenger Seats
Bell 206B-3 Jet Ranger	Jet	97	429/945	324/715	4
Bell 212	Jet	100	1,270/2,800	907/2,000	13
Bell 214 B-1	Jet	140	1,089/2,400	1,667/3,675	15-20
Boeing Vertol BV 107	Jet	120	4,400/9,700	4,400/9,700	n/a
Boeing Vertol BV 234	Jet	135	11,657/27,000	11,657/27,000	n/a
Eurocopter (MBB) BO-105 CB	Jet	110	635/1,400	445/980	4
Eurocopter BK-117A-4	Jet	120	599/1,320	417/920	11
Sikorsky S-58T	Jet	90	1,486/3,275	1,168/2,575	12-18
Sikorsky S-61N	Jet	120	2,005/4,420	2,005/4,420	n/a
Sikorsky S-64 Skycrane	Jet	80	7,439/16,400	7,439/16,400	n/a

* Use when takeoff and landing areas are relatively flat and load is nonjettisonable. Actual payload will vary based on elevation and temperature, amount of fuel, and other factors.

† Use for sling load missions (cargo is placed in a net or suspended from a line and picked up and moved by the helicopter using a belly hook) and adverse terrain (landing areas on top of steep ridges or adjacent to cliffs) or weather. Actual payload will vary based on elevation and temperature, amount of fuel, and other factors.

E. Ocean and Overland Transport

Ocean shipment always uses containerized cargo where the cargo is preloaded into closed containers and then loaded onto container ships. Containers may contain preloaded skids or be bulk-loaded. The type of overland transport depends on local road conditions and vehicle availability. Truck transport may use containers, or the trucks may be loaded with skids or bulk-loaded to fill the available space. When planning for loading containers or trucks with skids, know the container and the skid dimensions and whether the skids are stackable, so that the number of skids that can be placed in a container or truck can be determined.

Typical dimensions and specifications of the most common containers are listed in table C-3; however, checking on the availability and specifications of overland carriers with local transport companies is recommended.

Table C-3. Overland Transport Capacities

Type of Surface Carrier	Payload	Cubic Capacity (m ³)
Standard Sea/Land Containers		
20 ft (6.1 m)	22 t	33
20 ft high cube (HC)	28 t	37
40 ft (12.2 m)	26 t	67
40 ft HC	26 t	76
Other Carriers		
Standard railway car	30 t	52
Large lorry and trailer	20–30 t	n/a
Large articulated lorry	30–40 t	n/a
Medium lorry	5–8 t	n/a
Long wheelbase Land Rover, Land Cruiser, or pickup truck	1 t	n/a
Typical water tanker	8 t	8
Hand-drawn cart	300 kg	n/a
Camel	250 kg (more for short distances)	
Donkey	100 kg	n/a
Bicycle	100 kg	n/a

Appendix D

DART Communications

DART COMMUNICATIONS

A. Requirements

The U.S. Agency for International Development (USAID) Disaster Assistance Response Team (DART) has the responsibility to communicate with the following.

- U.S. Embassy/USAID Mission (USAID/Embassy).
- OFDA in Washington (OFDA/W).
- Affected-country officials as required.
- Relevant parties within the DART organization and potentially at dispersed sites in the affected country.
- Private voluntary organizations (PVOs), nongovernmental organizations (NGOs), international organizations (IOs), and United Nations (UN) relief organizations.

B. Systems

1. General

A DART uses three main types of communications systems:

- Public switched telephone networks (PSTN), also called the local phone system, to include international and countrywide cell phone coverage.
- Satellite (Inmarsat and VSAT) systems.
- Radio (HF/VHF/UHF) networks and systems.

Communications systems are chosen based on DART requirements. These include the following.

- Need for high-volume use.
- Portability.
- Ability to support various modes of communication, including, among others:
 - Standard voice.
 - Computer data (networked or stand-alone e-mail connections).
 - Fax.
 - Text-only messaging and video conferencing.

2. Local Phone System

Services. Services, quality, and availability vary with disaster locations. Following a disaster, if phone service is available, voice-grade lines will be available first (digital- and computer-grade lines may not be immediately available). Available phone circuits may be overloaded, and accessing outside lines may be difficult. Standard phone services are capable of providing ordinary voice and fax modes. Computer modes (e-mail/networking) and extremely high-grade video conferencing modes require specially conditioned phone lines that are not always available.

Operating Range. Nearly all metropolitan areas worldwide offer some degree of telephone services, but these services are not always available in rural areas.

Terrain Effects. Overhead telephone lines suspended on poles are often among the first casualties of natural or human-caused disasters.

Weather Effects. Wet conditions may cause degradation or disconnection of telephone signals. Severe weather may knock down telephone poles, completely disrupting services.

Setup Time. It may take up to 10 minutes to learn and understand different dialing procedures. Because of overloaded circuits and the poor quality of telephone connections, patience may be required when attempting to make connections.

3. Countrywide or International Cell Phones

Services. Cell phone coverage and reliability are normally determined before arriving in-country. The Global System for Mobile Communications (GSM) network provides complete cell phone coverage in countries that have a GSM network. When the GSM network is not available, most countries have local networks available to use with the purchase of cell phone chips (smart cards). The chip refers to an actual internal chip inside the phone. The phone must be equipped with this and the network must support the phone.

Operating Range. Nearly all metropolitan areas worldwide offer some type of cell phone service, but the signal strength is not always reliable in rural areas.

Terrain Effects. Terrain typically does not affect cell phone coverage.

Weather Effects. Weather-related conditions do not affect usage of cell phones.

Setup Time. If using a GSM network or local network cell phone, the setup time will be seconds, the time required to turn the phone on.

4. Satellite Terminal Systems

Services. Common telephone and data services are available from land-based terminals using the portable International Maritime Satellite (Inmarsat) or semifixed Very Small Aperture Terminal (VSAT) satellite network. These services include voice, fax, and e-mail communications. Any device that works with a common telephone device works with satellite systems. In addition to the above-mentioned services, some satellite terminals offer transferring of digital photographs or live video conferencing. Satellite signals may be digitally processed, giving your voice a digitized-sounding characteristic. Table D-1 contains additional information about satellite terminal systems.

Operating Range. Satellite terminal systems operate at any location between latitudes of 70° N. and 70° S. worldwide.

Terrain Effects. The satellite antenna or dish must have a clear, unobstructed view of the sky in the direction of the satellite.

Weather Effects. Heavy rains may impair the signal, and high winds may change the direction of the antenna or change the dish placement.

Frequency Selection. The operating frequency is set and is not under user control.

Setup Time. For portable Inmarsat terminals, setup can take 10 to 15 minutes. For VSAT terminals, setup can take 30 minutes to 3 hours or more (depending on system complexity).

Voltage Requirements. These systems require 90 to 250 VAC 50/60 Hz, 10 to 30 VDC, and generally will operate on any available electricity, including most automobiles.

Shipping Requirements. Depends on system.

5. HF/VHF/UHF Radio Networks and Systems

Services. Transmission of voice and digital data may be accomplished with two stations that are similarly equipped for the desired modes of communications. Table D-1 contains additional information about HF/VHF/UHF systems.

Operating Range. HF radio is most useful for long-distance communications. VHF/UHF are considered line-of-sight dependent, typically 3 to 10 miles. This range may be extended up to 30 to 40 miles with a high-mounted repeater and antenna. Range of special aircraft radios depends on the altitude of the aircraft.

Terrain Effects. Trees, buildings, mountains, etc., may limit range of all radio systems. UHF radio waves are best to penetrate confined spaces, such as collapsed buildings. VHF radio is a better choice for dense foliage, such as jungles. All radio antennas (especially HF) must be mounted in a high location in a clearing for best results.

Weather Effects. With the exception of the most severe rains and wind, weather has only a minor effect on HF and VHF. Some degradation on UHF during heavy rains may be noticed. Quality of HF communications depends on severity of solar activity (which changes throughout the day) in combination with the selected frequency. For this reason, multiple frequencies must be used throughout the day to effectively communicate with HF radio.

Frequency Selection. The Communications Officer determines specific operating frequencies. Use of existing USAID/Embassy frequencies may be authorized and are preferred. Frequency allocation from foreign governments takes time and is not automatic. Organizations such as UN/PVO/NGO/IOs, MARS (Military Affiliate Radio Systems), amateur radio networks, etc., may have prior frequency arrangements that the DART, if authorized, may take advantage of.

Setup Times. Initial base stations or repeaters require 30 minutes to 2 hours to set up. Installation (if required) of taller antennas, additional data modes, or more complex network systems may take several hours. Programming of radio frequencies may require up to 10 minutes per unit.

Voltage Requirements. These systems require 90 to 250 VAC 50/60 Hz, 10 to 30 VDC, and generally will operate on any available electricity, including most automobiles.

Shipping and Handling. Radios are considered by many governments to be controlled items. Special considerations (licenses, declarations, or authorizations) may be required before importation into the affected country.

C. Policy on Use of Frequencies

In all cases, the host government has the authority and the responsibility to control the use of communications equipment within its borders. A reasonable attempt must be made by the DART to obtain authorization from the host government for the use of radio communications equipment. The DART Communications Officer will request authorization through USAID/Embassy. Written authorization is preferred, but may not be possible to obtain in times of disasters. Frequency selection by the DART is the responsibility of the Communications Officer.

Table D-1. Characteristics of Radio and Satellite Communications

Type and Range	Equipment and Remarks
VHF/UHF, 3–25 miles, line-of-sight	Hand-held or mobile units. Antenna size and terrain affect range. Use for onsite coordination, personal security, and individual communications.
VHF/UHF with repeater, wider range	Same as above, but with a repeater station placed in the highest possible location.
HF (shortwave/voice), regional to worldwide	Mobile stations (automobile radio size) and base stations. Range depends on antenna used. Use for regional communications, 50–1,000 miles.
HF (shortwave/data), regional to worldwide	Base station includes modem, laptop computer, power supply, and antenna. Needs qualified operator. Data links with similar stations worldwide.
Standard M, Inmarsat worldwide satellite terminal	Attaché case with flat antenna in lid. Use for phone, fax, or e-mail. Requires separate laptop computer or fax machine.
M4	Inmarsat Satellite Terminal connects to laptop and supports all Inmarsat's Global Area Network (GAN) services including Mobile Packet Data Service (MPDS), Secure Telephone Unit, third generation (STU-III) encryption calls, and mini-M high-speed quality voice and fax.

Table D-1. Characteristics of Radio and Satellite Communications (continued)

Type and Range	Equipment and Remarks
RBGAN	Portable high-speed data satellite terminal that receives packet data over a 144-kbps shared channel. Allows file transfer at broadband speed, high-speed, and File Transfer Protocol (FTP); virtual private network (VPN) connectivity; Internet access; web browsing; e-mail (POP3 and IMAP); digital image transfer; General Packet Radio Service (GPRS); and file sharing.
Thuraya	Dual mode portable (GSM and satellite) phone that integrates terrestrial and satellite services, expands the boundaries of local telecommunications providers, and allows for vast roaming without service interruption or failure. Available mobile satellite telecommunications services include voice, fax, data, global positioning system (GPS), and text messaging.
Iridium	Portable satellite phone provides mobile satellite voice and data solutions with complete global coverage through a constellation of 66 low earth orbiting (LES) satellites.

D. Radio Identification and Communications Procedures

1. Radio Identification

Radio identifications or call signs will be assigned by the Communications Officer in accordance with international agreements, host government laws, or USAID/Embassy policies. As a security precaution, coordinate with the Embassy in the selection of a call sign that does not indicate you are a ranking official or authority figure.

2. Communications Procedures

The following radio communications procedures should be used.

- Speak clearly, using plain language and no codes.
- Begin the transmission with the call sign of the station you are calling, followed with your call sign.
- If a reply is expected, end your transmission with over.
- If no reply is anticipated, end your transmission with out.
- Use standard phonetics, as provided in table D-2, for call signs, station identifications, and spelling of words and names that may not be easily understood.

Table D-2. Phonetic Alphabet

A	alpha	J	juliet	S	sierra
B	bravo	K	kilo	T	tango
C	charlie	L	lima	U	uniform
D	delta	M	mike	V	victor
E	echo	N	november	W	whiskey
F	foxtrot	O	oscar	X	x-ray
G	golf	P	papa	Y	yankee
H	hotel	Q	quebec	Z	zulu
I	india	R	romeo		

Appendix E

Location Referencing and Mapping Resources

LOCATION REFERENCING AND MAPPING RESOURCES

U.S. Agency for International Development (USAID) Office of U.S. Foreign Disaster Assistance (OFDA) field team members are often required to record and communicate location information, tasks that must be performed efficiently, unambiguously, and with sufficient precision. In addition, field team members may be provided detailed location information at times and required to navigate to the place of interest. This appendix provides a basic reference to assist in that effort and provides guidance on references and resources available to assist field teams with geographic information including, but not limited to, maps, satellite imagery, and locations of humanitarian points of interest.

Note: Place names are often general knowledge among humanitarian responders; however, political sensitivities regarding place names and administrative boundaries may exist. Ask the Response Management Team (RMT) or OFDA Geographic Information Unit (GIU) for guidance on the names officially recognized by the U.S. Government (USG).

A. How To Reference Location

1. Precision

Before collecting location information, consider the needs of your primary and secondary audiences. The main issue to be resolved is the required level of precision. Does the information you are collecting need to be reported/displayed at a state or province level (low level of precision), at a town or neighborhood level (medium level of precision), or is a specific address or set of coordinates required (high level of precision)? Although your initial audience may require only a low level of precision, often the same information is later required at a higher level of precision.

Although precise information can be made more general, general information cannot be made more precise; therefore, USAID/OFDA recommends that you collect the information with the highest level of precision reasonably possible without adding a significant risk or burden to the team. Precise information can be aggregated for use in broader analyses or strategic level planning while still serving field-level utility, thereby satisfying multiple needs.

Low level of precision location information is gathered at a broad scale, such as the state or province level. Information gathered at this level is suitable for analyses at a broad scale, such as at the OFDA/W level.

Medium level of precision location information is gathered at a town or neighborhood level. Although more informative than low precision location information, medium precision location information is often too general to be useful at the field level.

High level of precision location information can comprise addresses in urban environments, landmark navigation from known points, or coordinates.

- **Address.** Many countries employ systems to supply unique addresses to buildings and homes. Talk to colleagues that have this local knowledge to determine if this option is available. Augmenting address information with one of the other techniques may be advisable, depending on your audience.
- **Landmark Navigation.** In many cases, describing the location of a point of interest in terms of its distance and direction from a known point is sufficient, e.g., “A spontaneous internally displaced persons (IDP) settlement was established 8 km from Kalima on the road to Shabunda.” Key information conveyed is that this distance is an “over the road distance,” as opposed to “as the crow flies.” Providing all the information that makes this information unambiguous, such as the specific road segment and distance and units of measure, is also important.
- **Coordinates.** The most precise way to communicate location is with a complete latitude and longitude record, often referred to as a “lat/long.” Another coordinate system that may be encountered in the field is the Military Grid Reference System (MGRS). Both systems divide the earth into grids; however, significant differences exist between the two (see “Coordinate Referencing System” below).

Obtaining detailed imagery for your area of interest to facilitate gathering location information with a high level of precision may be possible. An added benefit of using imagery is that it may be an important means of monitoring the area should access be cut off in the future.

In rare cases, high precision information might be considered sensitive or, as in the case of IDP camps during conflict, might

place vulnerable populations at risk of further violence. As part of the USG, field teams should must protect this information if acquired and use appropriate discretion when collecting.

2. Coordinate Referencing Systems

Latitude/longitude coordinates can be displayed in three formats without changing the location or precision of the point being referenced. These formats are degrees, minutes, seconds (DMS); decimal minutes (DM); and decimal degrees (DD). The following examples represent the same location.

- DMS: N 27°15'12" E 120°45'58"
- DM: N 27°15.2' E 120°45.967'
- DD: N 27.25333° E 120.7661°

The following formula can be used to convert DMS to DD.

$$DD = \text{degrees} + (\text{minutes} + \text{seconds}/60)/60$$

Most global positioning system (GPS) units, however, can make these conversions.

Latitude/longitude is a Cartesian coordinate system with the Equator being 0° latitude and the prime meridian being 0° longitude. Coordinates south of the Equator and west of the prime meridian can also be represented by negative numbers (-). Thus, S 27.25333° W 120.7661° could also be referred to as -27.25333° - 120.7661°.

The Military Grid Referencing System (MGRS) is explained in detail in the margin of maps produced by the military. Each component of an MGRS coordinate contains information on a progressively smaller grid read from left to right. For the coordinate 16SFL456987, the 16S represents an area stretching from the Equator to the South Pole, FL represents a small portion of that area, and 456987 represents a smaller area of the FL grid. In the field, an MGRS coordinate may often be reduced for more efficient communications (e.g., 456987 versus 16SFL456987). This typically occurs when the entire area of interest lies within the larger grid designated by 16SFL. Note that 456987 indicates a 1,000 m by 1,000 m grid area and may not be sufficiently precise for navigation. By adding two digits, the precision can be improved to a more useful 100 m by 100 m area; adding two more digits further increases the precision to 10 m by 10 m. Therefore, each additional pair of digits within the MGRS coordinate increases the precision of the area represented by a factor of 100.

Precision of the Area Represented	Example
1 km ²	16S FL 123 123
10,000 m ²	16S FL 1234 1234
100 m ²	16S FL 12345 12345

Converting between systems ensures the ability to use maps and data provided from all sources. Field teams may receive location information in many formats, and the ability to identify these locations on maps can be invaluable. In most cases, the simplest way to convert between formats and referencing systems is to use the GPS units included in the field communications equipment cache. The GPS will change all stored points to the reference system selected by the user. Coordinate conversion can also be accomplished by using maps that have dual grid systems. Most maps produced for the military contain both referencing systems described here.

Differences between the latitude/longitude and MGRS coordinate systems are displayed in table E-1.

Table E-1. Comparison of Latitude/Longitude and MGRS Coordinate Systems

Latitude/Longitude	MGRS
Divides globe into degrees, minutes, and seconds	Divides globe into grid system based on meters
Coordinate describes an exact point	Coordinate describes a grid cell or area
Can be made more or less specific by including or removing significant digits	Can be made more or less specific by including or removing significant digits
Standard coordinate system for civilian users	Standard coordinate system for military users
Provided by all GPS units	Provided by all GPS units
Example: N 27°15'12" E 120°45'58"	Example: 16SFL456987

B. Mapping Resources

1. Getting Started

The RMT and/or GIU can provide access to the full range of mapping resources for field missions. In many cases, the best available maps may be in the field. Team members are encouraged to actively seek maps within the region and explore local sources such as municipal authorities, United Nations agencies, NGOs, and local universities.

If an RMT is activated, it will manage requests for maps before and during deployment. The RMT must coordinate such requests because it will have the most complete inventory of what is available, ensure follow-through, and combine all requests to provide a full understanding of field mapping needs. If an RMT is not activated, the GIU will manage these requests directly.

The GIU provides geographic information support for OFDA/W, field teams, and partners. A member of the GIU is always included on RMTs, and mapping experts can be contacted at all times to respond to field needs. The GIU maintains a significant stock of map resources and interagency agreements to ensure access to all available resources. GIU staff or other mapping specialists can deploy as part of field teams as technical specialists when requested by the field team.

In some cases, maps provided to field teams will have distribution limitations placed on them. These maps, although not classified, should not be provided or shown to non-USG personnel. Maps in this category should be marked clearly with LIMDIS (Limited Distribution) or FOUO (For Official Use Only). In certain situations, these limitations can be relaxed by petitioning the producers of the map and presenting a clear and compelling justification. In all cases, maps produced for, provided to, or purchased by the field team are property of the USG and must be treated as such. All maps should be left with an appropriate partner or returned to OFDA/W for storage and reuse.

2. Map Products

Reference maps, such as tourist maps and topographic maps, are used for navigation or general geographic awareness. Reference maps of many types are available to field teams and can either be acquired directly from local sources or through

OFDA/W. Often maps acquired in the field exceed the quality of those available at OFDA/W. Should this occur, consider providing a copy to OFDA/W so that all parties use the same maps.

Thematic maps attempt to illuminate a specific issue or issues related to the humanitarian crisis, affected population, or geographic area, such as situation maps, program activity maps, and natural hazard maps, respectively. These products are often created from information provided by the field teams and are intended to broaden the understanding of the readers to the geographic realities of the situation. OFDA and other organizations produce custom maps displaying aspects of the humanitarian situation that are often posted online or available in field coordination centers. Custom maps can be produced for field teams on request.

Satellite imagery may be available from commercial satellites that can now collect imagery of sufficient detail to produce quick road maps of urban areas, provide initial damage assessments, or monitor displaced persons camps. Imaging satellites can detect features smaller than 1 square meter that can, in certain circumstances, provide a unique and useful perspective on areas of humanitarian interest. As with maps, field teams are encouraged to request imagery when appropriate and potentially useful. Manipulation of the imagery requires specialized training and software. A request for imagery support will typically result in a report, table, or map containing information about the features of interest. Atmospheric (clouds, dust, and haze) and technical constraints can delay or deny the collection of satellite imagery. If possible, urgent needs for overhead analysis, especially in the case of damage assessment, should be managed in-country with aircraft.

Appendix F

Working With the Military in the Field

WORKING WITH THE MILITARY IN THE FIELD

The information in this appendix is intended to inform Assessment Teams and Disaster Assistance Response Teams (DARTs) about working with military organizations during field operations. This information will focus mainly on those response activities where the Office of U.S. Foreign Disaster Assistance (OFDA) works with the U.S. military, but the information may be applicable to working with coalition and multinational military forces, such as the North Atlantic Treaty Organization (NATO). The information includes how the military organizes and conducts field operations and how, when, and where Assessment Teams and DARTs can coordinate OFDA's disaster response operations with military operations.

For more information, several military publications dealing with military doctrine for humanitarian relief activities are available through OFDA's Washington, DC (OFDA/W's), Operations Division. Chapter V, "Commonly Used Acronyms and Terminology," has additional DOD terms.

A. Military Operations Involving Coordination With OFDA Disaster Response Activities

In general, the relief operations involving the military can be divided into two categories: natural disasters and complex emergencies. Natural disasters include earthquakes, hurricanes, droughts, etc., and are not initiated by or involved in human conflict. Complex emergencies are situations that develop because of or during a human conflict (war, insurgency, riots, etc.). When the military's mission is in support of humanitarian assistance, the DART will have much more significant involvement and input into the military's operational planning and activities. If, however, the military mission is to carry out peace operations or another more traditional military mission, the DART's involvement will focus on the humanitarian aspects of that operation.

1. Natural Disasters

a. Point-to-Point Logistical Support

When OFDA's response option to a disaster is to provide relief commodities from OFDA stockpiles and commercial

aircraft are unable to meet the time or operational requirements for delivery of those commodities, OFDA may request the use of Department of Defense (DOD) aircraft for which DOD will most likely be reimbursed. These U.S. military aircraft may be used to airlift OFDA relief commodities to a point close to the disaster site or to shuttle relief commodities within the area of the disaster. To arrange for this military airlift support, OFDA's Logistics Officer will prepare documentation that specifically details when, where, and what type of support is needed and how that support will be reimbursed. When the requirements have been identified and accepted by DOD, OFDA Logistics will continue to coordinate with the appropriate military staffs to expedite the delivery of the commodities. OFDA Logistics may request assistance from an Assessment Team or DART with customs, offloading, consignment, and accounting for the relief commodities.

OFDA also works very closely with the State Department's Office of Political/Military Affairs (PM). PM often serves as a facilitator between DOD and OFDA. For example, when DOD receives a request for support to a nongovernmental organization (NGO) that requires validation, or when no military presence is available in an affected country, OFDA will work with PM to assist in validating and targeting the response activities.

Other key partners within DOD include:

- The Office of the Secretary of Defense (OSD).
 - Defense Security Cooperation Agency (DSCA).
 - Office of the Assistant Secretary of Defense for Special Operations/Low-Intensity Conflict.
- Joint Chiefs of Staff.

b. Disaster Relief

When the military is involved in disaster relief activities, military assets are provided *primarily* to supplement or complement the relief efforts of the affected country's civil authorities or humanitarian relief community. This support may include providing logistical support, transportation, airfield management, communications, medical support, distribution of relief commodities, or security. In such cases, OFDA will assign personnel to work at different levels of the military organization (see "Military Structure during Operations" below), including the field or tactical levels, as

liaisons between the military and the relief community to ensure that the efforts of both are mutually supportive and not duplicative. The military has recognized OFDA liaisons and representatives as valuable members of their staff and has looked to them to foster a unity of effort in humanitarian assistance.

2. Complex Emergencies

Complex emergencies involve relief operations that are conducted in the midst of an armed conflict or in conjunction with military and diplomatic efforts to prevent or end an armed conflict.

a. Peace Operations

Peace operations are military operations conducted in support of diplomatic efforts to establish and maintain peace. These operations may also have a humanitarian relief component. Peace operations are usually one of the two following types.

- **Peacekeeping.** Military operations undertaken with the consent of all major parties to a dispute, designed to monitor and facilitate implementation of an agreement (cease-fire, truce, etc.), and support diplomatic efforts, such as negotiations, mediation, arbitration, and judicial means, to reach a long-term political settlement. If the military force is deploying under a United Nations (UN) mandate, this type of operation is usually referred to as a “Chapter VI operation,” referring to Chapter VI of the UN Charter, which is titled “Pacific Settlement of Disputes.”
- **Peace Enforcement.** Application of military force or threat of its use to compel compliance with resolutions or sanctions designed to maintain or restore peace and order. If the deployment in this case is under a UN mandate, this type of operation is usually referred to as a “Chapter VII operation,” referring to Chapter VII of the UN Charter, which is titled “Action with Respect to Threats to the Peace, Breaches of the Peace, and Acts of Aggression.”

b. Relief Operations During Conflict

Relief operations during conflict are fundamentally similar to peace enforcement operations in scope, intent, and procedures. In both types of operations, any or all of these conditions are possible.

- The DART will be involved in coordinating relief efforts in concert with U.S. military operations.

- The UN will not have necessarily issued a mandate (Chapter VI or VII) and may not have the lead role.
- The role of the DART as an impartial humanitarian effort becomes blurred in the eyes of the target audience, and perhaps in the eyes of other donors, international organizations (IOs), and NGOs.
- DART members become potential targets of American opponents and therefore must increase team security, which reduces the DART's operational capacity.

B. Characteristics of Military Culture

1. Organizational Culture

Like most organizations, the military has a distinct organizational culture with an often unwritten set of rules, regulations, viewpoints, perspectives, and operating procedures. This culture is based on the unique tradition, mission, structure, and leadership of military history. DART members who are aware of the military environment and culture will be better prepared to liaise with relief community members who have not worked with the military. Some of the main characteristics of the military organizational culture are the following.

- Highly structured and authoritarian way of life with a mission-focused, goal-oriented approach—both explicit and implied.
- Strict sense of discipline, tending to adhere to rules and regulations.
- Strong work ethic with high regard for physical and mental strength.
- Decisive leadership that expects loyalty of subordinates and allies.

The following section describes how the military's cultural norms may be displayed to the relief community during an operation.

a. Meetings

Military personnel expect meetings to be highly structured and efficiently managed by someone "in charge." Meetings attended by autonomous relief agencies expecting a consensus approach to issue resolution may be viewed by the military as inefficient and lacking focus. The military expects

that meeting participants will leave with a clear understanding of their task.

b. Coordination

Concern for operational security will likely result in a reluctance to share information about planned activities, although the military can be expected to want indepth information about civilian activities. The military will respond well to clearly stated missions, efficient processes, organization, responsibility, and competence.

c. Operational View of the Mission

Some military leaders may be concerned that humanitarian operations degrade combat readiness. This may result in a desire to minimize participation in some operations. Although humanitarian operations may be viewed with mixed feelings organizationally, the military is excellent at dutifully executing national direction and generally feels a great sense of accomplishment at helping others in need. If this direction is clearly to support humanitarian operations, the military's response can be provided effectively with a single-minded purpose.

d. Deployment

The military deploys with a comparatively high standard of support that is designed to make the military as self-sustaining and self-reliant as possible. The military tries to avoid "mission creep," which occurs when armed forces take on a broader mission than they initially planned for. Recently, the military has incorporated humanitarian assistance into its mission planning process. When these missions are planned and executed, the DART must be involved to ensure interagency coordination and a single focus. **Bereft of outside agency input, the military will generally fill the void as it sees fit.**

Overriding all other priorities will be internal force protection. Force protection is the security program designed to emphasize the protection of soldiers, civilian employees, facilities, and equipment that are part of the military organization. Force protection will have significant impacts on disaster relief operations, thus affecting freedom of movement, security, and logistics.

C. Military Structure During Operations

1. Chain of Command

The Department of Defense receives direction from the National Command Authority (NCA), which consists of the President of the United States and the Secretary of Defense, or their duly authorized alternates or successors. The NCA has the constitutional authority to direct the Armed Forces of the United States. NCA direction is passed to the chairman of the Joint Chiefs of Staff (JCS). The JCS consists of the chairman and the chiefs of staff of the various services (Army, Navy, Marines, and Air Force). The military divides the world into five geographic areas or areas of responsibility (AORs). The JCS chairman directs commanders of various AORs to carry out operational activities. An admiral or general in each AOR, called the Combatant Commander (CC), will head U.S. military operations for that particular AOR. The AORs are listed below and defined in chapter V.

- **European Command (EUCOM).**
- **Pacific Command (PACOM).**
- **Central Command (CENTCOM).**
- **Southern Command (SOUTHCOM).**
- **Northern Command (NORTHCOM).**

In addition to geographical commands, OFDA works with the following two other functional commands on a regular basis.

- **Special Operations Command (SOCOM).** In command of special operations units that include, among others, Special Forces, Civil Affairs, and Psychological Operations (PSYOPS). Headquarters is in Tampa, Florida.
- **Transportation Command (TRANSCOM).** Unified command for providing management of all surface/air/sea lift. Headquarters is at Scott Air Force Base, Illinois.

2. CC Authorities During Critical Humanitarian Relief Situations

CCs have an inherent authority in their AORs to respond to a disaster in cases of imminent loss of life or limb, even if the U.S. Ambassador in the affected country has not issued a disaster declaration. OFDA may work with the CC to share costs on certain relief activities.

3. Humanitarian Assistance Survey Team

Some CCs have developed what they call a Humanitarian Assistance Survey Team (HAST) to assess existing conditions after a disaster and the need for military forces. HASTs usually focus on the requirements for military support to the relief effort and the ability of the affected country to handle the deployment of follow-on forces (e.g., airport or seaport capabilities). Assessment Teams or DARTs may encounter HASTs in the field. If Assessment Teams or DARTs encounter HASTs, they should first ascertain the objectives of the mission of the HAST. If the HAST mission involves identifying victim needs, the Assessment Team or DART must determine what the HAST has identified as priority requirements and its recommendations. Coordination of efforts is key to a successful operation.

4. Joint Task Force

During a large-scale disaster response, the CC may set up a Joint Task Force (JTF) or Combined Support Force (CSF) for the field management of large military activities. A JTF or CSF is established when a mission involves two or more military services on a significant scale and requires close integration of effort to meet specific military objectives. The CC designates a commander for the JTF who is responsible to the CC.

The JTF is divided into the following six main command staff designations that correspond to those at the CC headquarters and the Joint Staff.

- J-1** Administration; deals with internal personnel issues.
- J-2** Intelligence; gathers, analyzes, and reports on information, including classified information.
- J-3** Operations; mainly focuses on current operations.
- J-4** Logistics; provides internal support for the JTF and may include support to disaster victims.
- J-5** Plans and Policies; normal location of Civil Military Operations Center (CMOC) (see below).
- J-6** Communications; provides all telecommunications needs for JTF.

5. Civil Military Operations Center

U.S. military forces participating in a humanitarian operation will in most cases establish a CMOC or similar coordination center

with another name. The purpose of a CMOC is to coordinate and facilitate the United States' and any multinational force's humanitarian operations with those of international and local relief agencies and with the affected country authorities. The CMOC will look to the DART representatives to provide advice to the CMOC staff and assist in screening and validating requests for military support from the relief community. DART representatives can also provide a valuable service to the CMOC by informing the CMOC staff of the capabilities, areas of expertise, and operational methods of the relief organizations. Similarly, the DART representative can advise and educate the relief organizations about the military. The CMOCs, depending on the size and nature of the military operation, may play a larger role than just coordinating the military's involvement in humanitarian relief efforts. CMOC responsibilities remain the same, regardless of changes in nomenclature, size, or location. The CMOC is called a Civil Military Center when it falls under the auspices of NATO or a UN-mandated coalition. In some cases, the CMOC has been involved in repairing infrastructure and supporting the reinstatement of civil administration, such as a police force and a judicial system.

The exact organizational structure for military support to humanitarian operations has been highly operation-specific. In some cases, the CMOC has used subordinate elements to facilitate or expand its mission, while in other cases, larger umbrella organizations were established that included the CMOC. Such organizations have included the Humanitarian Assistance Coordination Center (HACC) that managed military support to humanitarian operations in Haiti, the Humanitarian Information Center that fostered information dissemination during the Kosovo crisis, a Humanitarian Operations Center (HOC) to coordinate movement in Iraq, and a Coalition Humanitarian Liaison Center to expedite regional activities in Afghanistan.

6. Special Operations Forces

All the units involved with Civil Military Operations fall under the command, policy, and procedures of U.S. Special Operations Command (SOCOM). This command is responsible for the U.S. military's unconventional operations that include, among others, civil affairs and psychological operations. Some significant differences separate these units and individuals from the standard military profile. First, most of the units are regionally focused and have varying degrees of language capability that allow them

to be culturally aware and communicate. Second, more than 95 percent of the Civil Affairs and PSYOPS members are in the Army Reserve inventory, which means that most of the personnel work daily in their specific civilian field (i.e., transportation manager, city controller, judicial administration, etc.) and are professionally current in their field. Third, because they are in an unconventional command, are culturally aware, and work in civilian areas most of the time, the personnel in these units generally tend to be more flexible and creative and less rigid in their thoughts and ideas.

a. *Civil Affairs*

CMOCs and HACCs are usually staffed by personnel from Civil Affairs (CA) units in the Army or the Civil Affairs Group (CAG) in the Marine Corps. Their function is to provide the interface between the military and the civilian population, organizations, and government. CA personnel are a part of the Army's SOCOM or Marine Corps CAG and are trained in skills such as governmental functions, economics, and public infrastructure management, which make them an optimal choice to form the core of the CMOC staff, into which other functional military specialists integrate. CA personnel are capable of supporting humanitarian assistance operations in a variety of functional areas. CA units may serve as the primary advisor to the JTF Commander (CJTF) on the impact of military activities on the civilian sector. They also provide a primary military liaison with local civil authorities in the affected country.

b. *PSYOPS*

Another SOCOM group that DART representatives may encounter in a JTF setting is PSYOPS. PSYOPS units convey messages and themes intended to have an impact on selected target audiences. Their objective is to influence behavior and attitudes and constrain undesirable actions. PSYOPS personnel can provide the CJTF with analyses of perceptions and attitudes of the civilian population and the effectiveness of ongoing information campaigns and humanitarian assistance operations. They also provide language capability and equipment, such as radio broadcasting, print, loudspeakers, and audiovisuals, to disseminate necessary information to the affected population. DART representatives must track PSYOPS actions closely to ensure that the goals and operational activities of OFDA's field staff and those of the JTF, through PSYOPS, are tracking consistently to avoid

a conflict in the message and actions of the U.S. Government (USG) toward the victims and relief community.

D. Your Deployment With the Military











1. Before Departing

Both OFDA and the military appreciate the value of having you, a DART Military Liaison Officer (MLO), present with the JTF. Not all military commanders, however, have worked with or are even familiar with the mission and field operational methods of other USG agencies, including OFDA. Therefore, OFDA/W must coordinate with the appropriate CC staff to define your scope of work (SOW). Some military offices may refer to a SOW as a “terms of reference” (TOR). OFDA/W should then request through the CC staff (1) a point of contact (POC) for you to facilitate your entry into the military organization and (2) that your SOW/TOR be forwarded to the JTF. OFDA/W should also cable your security clearance level in a message cable to the geographical CC and the JTF if possible. Without that information, gaining access to the military installation or the JTF and then to planning meetings and briefings may prove difficult. Always carry copies of your travel orders (TO) and your SOW/TOR letter.

2. Arrival

On arriving at the JTF as the MLO, you should have a copy of your TO with security clearance, passport, USAID/OFDA badge, a letter with SOW/TOR, and/or any paperwork that clearly establishes your identity and position. Given the high level of communication currently available, you should already have obtained a POC from the CMOC; have that contact information available. When contact is established with the CMOC counterpart, ensure that you are “badged” and have access to all areas and briefings required for you to be effective. Table F-1 lists the titles, ranks, and insignias of commissioned officers, and can help you distinguish among officers of different ranks.

Table F-1. Title, Insignia, and Rank of U.S. Military Commissioned Officers

Army, Air Force, and Marine Title	Insignia	Picture	Rank	Equivalent Navy, Coast Guard, or Public Health Service Title
Second lieutenant	1 gold bar		0-1	Ensign
First lieutenant	1 silver bar		0-2	Lieutenant (junior grade)
Captain	2 silver bars		0-3	Lieutenant
Major	Gold oak leaf		0-4	Lieutenant commander
Lieutenant colonel	Silver oak leaf		0-5	Commander
Colonel	Silver eagle		0-6	Captain
Brigadier general	1 star		0-7	Rear admiral (lower half)
Major general	2 stars		0-8	Rear admiral (upper half)
Lieutenant general	3 stars		0-9	Vice-Admiral
General	4 stars		0-10	Admiral

3. Getting Visibility

After you have made the proper contacts in the CMOC, as soon as possible make an appointment with the JTF Commander and other senior staff. The “gatekeeper” for the JTF Commander is often the JTF Commander’s chief of staff, whom you may need to educate on your liaison role with the military operation. The JTF Commander’s availability to you and your importance to him or her will again depend on the operational mission of the JTF. If the operation’s focus is not humanitarian relief, your access to the JTF Commander will be limited. If the focus is humanitarian relief, you may find yourself dealing directly with the JTF Commander on a continual basis. The value added as DART MLO is to be able to present issues and concerns of DART in order to influence military actions that impact humanitarian assistance.

4. Your Mission

You will work most closely with the CMOC and with the commanding officer or director of that staff. The CMOC will usually have coordination meetings with the relief community to share information and to map out the requirements, capabilities, and mutual concerns. Your job is to observe and advise, not to facilitate or run CMOC meetings, which is the job of the CMOC staff. CMOC meetings will be held as required, probably daily. The military and the humanitarian relief community must understand that your mission is to advise and assist both sides to work toward a coordinated effort. This will mean that at times you may be caught between competing or conflicting desires and objectives. Do not compromise your status, because if either side sees or perceives you as favoring the other, your credibility and effectiveness in the job will be diminished. Your main task is to encourage the military’s operation to be as cooperative and supportive to the humanitarian relief effort as possible. But also realize that the military may have to temper that support within the context of its mission objectives.

5. Meetings and Briefings in the JTF

Within the time constraints that always exist in these types of operations, attend as many JTF planning meetings and briefings as possible, based on their relative value to the humanitarian relief effort. These meetings will keep you informed about what the military is doing and the problems and constraints that it are encountering.

6. Contact and Visibility With the Affected Country, UN Relief Agencies, Private/International/Nongovernmental Organizations, and Donor Governments

An important aspect of your assignment is ensuring that you and other members of the DART maintain contact and visibility with the relief community to better understand how their activities are progressing and what issues are arising between the relief community and the military.

Affected country relief officials, relief organizations, or donor governments may arrange these coordination meetings. The mechanism for coordination among these organizations will depend on the ability of the affected country or other lead coordinating agency to organize them. If the affected country does not have this capability or other coordinating agencies are unable to perform this role, other coordinating groups will come to the forefront, including, perhaps U.S. or foreign military.

The UN's High Commissioner for Refugees, Office for the Coordination of Humanitarian Affairs (OCHA), United Nations Children's Fund, and World Food Program may take on a coordination role by setting up coordination centers where private voluntary organizations (PVOs)/NGOs/IOs and UN relief agencies can discuss operational activities. These coordination centers may have various names such as Humanitarian Operations Centers (HOCs, the military term for this type of center), or Onsite Operations Coordination Centers (run by OCHA, or sectoral coordinating committees for such issues as health, nutrition, water, or sanitation. The PVOs/NGOs/IOs may also set up coordination groups in addition to or instead of other efforts. The CMOC director or staff may want to participate in these meetings as another way to assess requirements and to inform the relief community of the capabilities and limitations of the JTF to support relief operations.

7. Staffing

DART staffing for the JTF assignment is another important issue. You may be the only DART representative to a JTF or several staff members may be required to assist in the effort. It will be difficult to remain visible and involved with the military; work with the affected country, the relief community, and other donor governments; travel to relief sites; and continue to maintain a regular reporting schedule. Plan your staffing requirements accordingly.

8. Reporting

Before you leave OFDA in Washington, the reporting requirements must be decided: to whom, how often, and in what form. If the JTF is spread out and several DART members are with the JTF staff, what will be the reporting chain? When you are preparing your reports, keep several important issues in mind. The JTF will prepare at least one situation report a day. It may all be unclassified, partly classified (the usual case), or completely classified. Be aware that the information they have collected may have come from your situation report, the relief organizations, or CMOC staff directly. If the information they have collected is useful to the DART, make sure what you report through your reporting chain does not duplicate information you and other members of the DART in other locations have already reported. Clarify any differences in reporting data, such as tonnage carried or gallons of water purified. Remember that the U.S. military figures will not be in the metric system while most of the relief community information will be. Also, make sure the military information you report is not from the classified portion of their information. Be aware not only of classification but also of the sensitivity of military reports and information. You may be privy to their reporting, which may take several forms, such as situation reports, commander's reports to the CC, lessons-learned reports, and others. You must realize that what is submitted by the JTF may not be the total information or the same analysis or the same decision that comes out in Washington through the JCS. If you report what you read or overheard at the JTF as the military position, you may find that in reality the military position is much different in Washington than at the JTF level. And if the word gets back that you have been reporting incomplete information that has caused confusion up the chains of command of OFDA and the military, your credibility and effectiveness will certainly be compromised.

9. Support

When planning for your assignment, define with the Team Leader or OFDA/W how you and other DART members assigned to the military will be supported, especially if the JTF is not collocated with the DART headquarters. Will your support come from the USAID Mission, the U.S. Embassy, the DART Administration Officer, through an allotment to the mission or Embassy to pay for your support, or will you have to fend for yourself using an

amended travel authorization and increased cash advance? Identify in advance how you will be housed, fed, and transported to and from the JTF, and what type of telecommunications equipment you will have access to or should bring with you. What about simple issues like office supplies? Be as self-sufficient and independent of the JTF as possible because the JTF will be burdened enough with its own logistical and administrative issues. Your need for support may reduce your flexibility to respond to humanitarian relief issues, and it could affect your credibility with the JTF. You may be viewed as another support requirement instead of as an asset to the operation.

10. When Are You Done?

When is your job complete? Because you are closest to the military and humanitarian relief issues, you will be relied on by the Team Leader to define when your DART assignment is no longer necessary. Every effort should be made to ensure that the JTF's needs have been met. Be advised: if you have been useful and quite independent of JTF support, a tendency will often emerge in the JTF to want to keep you around for as long as possible, even when the value of your support has greatly diminished. You have to think in terms of the DART's needs as well as the JTF's.

11. Closeout

The closeout of a DART from a JTF is similar to any DART closeout. You must make sure that those groups that have been supporting you (mission, Embassy, and DART Administration Officer) are aware of the closeout assistance required. Enough lead time is always important. Complete any reporting requirements with the military, including exchanging any pertinent documents. Make sure that the relief community is aware of your departure, whether the military will remain, and how the community can access DART or OFDA for questions or concerns.

12. Other Assignments

On occasion, OFDA has assigned individuals to work with multinational military organizations, such as NATO military forces. Under these circumstances, the individuals assigned will be working independently of a DART. These individuals are referred to as Humanitarian Advisors (HUMADS). The HUMAD takes on the role of representing the interests of the entire relief

community, not just the USG. If you are assigned to serve as a HUMAD, having a well-defined SOW/TOR is critical as is the need for all parties that you will be working with, civilian and military, to understand the scope and limitations of your role.

As a final point, remember that a military operation with the magnitude of a JTF is very complex, and many times issues arise that are internal to the military and the JTF. Out of courtesy to the military, if you are present when internal issues arise and your presence is not needed, you may want to excuse yourself until these discussions are completed. This will be appreciated by the military and may prevent you from observing situations that may prove embarrassing to certain members of the JTF staff, especially when their actions (or lack thereof) are being discussed.

Appendix G

Chemical, Biological, Radiation, Nuclear, or Explosive Hazards

CHEMICAL, BIOLOGICAL, RADIATION, NUCLEAR, OR EXPLOSIVE HAZARDS

Every disaster deployment has some type of chemical, biological, radiation, nuclear, or explosion (CBRNE) hazard. CBRNE hazards include more than military weapons; they also include endemic diseases, epidemics, industrial chemicals, explosion hazards, pollution, and terrorist threats. Planning for CBRNE hazards and training to mitigate them greatly reduces risks to Disaster Assistance Response Team (DART) staff in the field.

The Foreign Disasters and Hazardous Substances Database was developed for U.S. Agency for International Development (USAID) staff to assist in identifying CBRNE hazards before deployment. The database comprises almost half a million records of CBRNE hazards world wide. The database is available via a secure connection to the Internet and also in PDA (Personal Digital Assistant) format. Check the database for hazards in the area of operations well before deployment.

USAID's Office of U.S. Foreign Disaster Assistance (OFDA) maintains a CBRNE hazards program. The program includes training for USAID staff and partners, a cache of safety supplies and equipment at Dobbins Air Reserve Base in Georgia, the Foreign Disasters and Hazardous Substances Database mentioned previously, and field surveys of disaster zones to assist USAID staff and partners in responding to disasters involving CBRNE hazards. Contact the Office of U.S. Foreign Disaster Assistance/ Washington (OFDA/W) Operations Division to obtain these services and supplies for your team. CBRNE hazards can often be addressed through good planning and training. Do not be a victim; get help with disasters involving CBRNE hazards.

A. Chemical Hazards

Chemicals can pose several types of hazards. Corrosive chemicals such as acids and bases burn the eyes, skin, and lungs. Flammable chemicals cause thermal burns and release toxic smoke. Toxic chemicals cause poisoning or infections. Reactive chemicals can start fires, release toxic or explosive vapors, or explode when coming in contact with other materials. Many chemicals present more than one type of hazard. Consider all these hazards when evaluating chemicals. The International Program on Chemical Safety (IPCS) has developed brief fact

sheets, called International Chemical Safety Cards (ICSCs), on many of the most common chemicals. ICSCs can be viewed on the IPCS Web site (<http://www.who.int/ipcs/publications/icsc>). Information about military chemical agents and other hazards can be found at the Virtual Naval Hospital Web site at <http://www.vnh.org>.

B. Biological Hazards

Biological hazards include bacteria, viruses, rickettsia, and parasites. Bacteria are one-celled organisms that cause infections or release toxic chemicals inside the body. These organisms include anthrax, plague, salmonella, shigella, and a host of other food- and water-borne pathogens, as well as most of the common biological weapons. Bacteria can usually be treated with antibiotics during the early stages of infection; therefore, understanding the types of common bacterial infections in the disaster zone can help a team prepare to maintain their own health as well as aid in restoring the health of the population in the affected area.

Viruses are simple strands of RNA or DNA surrounded by a protein sheath. They invade the body's cells and use these cells as nutrients to reproduce. Viral hazards in disaster zones include arthropod-borne viruses, such as yellow fever, and viruses transmitted from one person to another, such as smallpox, HIV, and hemorrhagic fever viruses. Viruses such as smallpox and Venezuelan equine encephalitis have been investigated as biological weapons. Some viruses can be prevented by vaccination, and many developing countries in tropical areas of Latin America and Africa require yellow fever vaccinations for people entering the country. See CDC's Traveler's Health Web site at <http://www.cdc.gov/travel/> for recommended vaccinations. OFDA staff can get vaccinations at Federal Occupational Health clinics in many cities in the United States, including in Washington, DC.

Rickettsial diseases include syphilis, Rocky Mountain spotted fever, and Q fever. They can often be treated with antibiotics.

Parasites include malaria, schistosome snails, pinworms, and tapeworms. Malaria can be prevented by obtaining the appropriate antimalarial prophylactic medicine before deployment and taking it as directed. Infections from snails and worms can be prevented by avoiding sluggish streams and rivers and by thoroughly cooking food.

C. Radiation and Nuclear Hazards

Radiation and nuclear hazards, which include nuclear power plants, industrial radiation devices, and nuclear weapons, result from energy and particles released from the nuclei of atoms. The energy released during a nuclear explosion, which comes from energy released from electron shells around the nuclei, can be more than 1 million times greater than that of a conventional explosion. Radiation includes alpha radiation (two protons and two neutrons released from the nucleus), beta radiation (small positively- or negatively-charged particles released from the nucleus), gamma and x-rays (energy), and neutrons.

Time of exposure, distance from the source of exposure, and level of shielding are the three major variables in determining injury from radiation. Alpha radiation travels only a few inches and can be stopped by a piece of paper, but can cause lung cancer if inhaled. Beta radiation can travel up to 2 meters, is absorbed by light-weight shielding materials such as aluminum, and can burn the skin. Gamma and x-rays travel several hundred meters, can penetrate the entire body, and damage cell tissues and DNA. Acute radiation sickness can result from large doses of radiation, and cancers can result from a broad range of exposures. Hot spots for nuclear explosions include India, Pakistan, Iran, and North Korea. Nuclear power plant hazards are greatest at plants designed and built by the former Soviet Union in Eastern Europe and Central Asia.

A radiation incident can create public panic and potentially result in a large displaced population seeking alternate shelter and health screening for potential exposure, which may create an additional healthcare burden on the local mental health and public health resources. Long-term effects could include ecological damage, loss of food and agricultural production, and human resettlement.

D. Explosive Hazards

Conventional explosive hazards commonly encountered by USAID staff include unexploded ordnance, landmines, and improvised explosive devices such as those made from commercial fertilizers. Most commercial explosives are used around extraction mines. In addition to trauma and burns, explosives can pose longer-term hazards to survivors, including infections, kidney damage from blast pressure waves, and adverse mental health effects.

Millions of landmines are still emplaced in nearly 60 countries around the world. Check with the U.S. Embassy's Regional Security Officer to learn more about known minefields before departing for your assignment.

Appendix H

Monitoring and Evaluation

MONITORING AND EVALUATION

A. Monitoring

Monitoring may be defined as the ongoing systematic collection, analysis, and use of data that occurs during the course of a project. The purpose of monitoring is to determine whether a project or program is being implemented as designed and is having the intended results. Good monitoring offers steady direction to project implementation and enhances performance, transparency, accountability, and quality reporting.

Common themes to consider when monitoring are project status, accomplishments, challenges, changes in context and beneficiaries, trends, partner performance, cost effectiveness, general observations, and followup issues. Monitoring should take into account the framework of the program, meaning the objectives, activities, their affiliated expected results, and the indicators by which progress will be measured. Good indicators are direct, objective, practical, adequate, and replicable. A combination of qualitative and quantitative indicators should be used to ensure a well-balanced representation of the program. Quantitative data often includes such information as commodity distribution, activity output, or beneficiary reach, whereas qualitative data might rank changes in confidence levels, behavior, or attitudes.

Primary monitoring tools for data collection are partner reports, official cables, key informant interviews, focus group discussions, random surveys, and direct observation. Performance monitoring plans (PMPs) are also considered strong monitoring tools that serve to gauge program progress. PMPs are designed primarily for project implementers and include the framework of the program (objectives, activities, expected results, and indicators) as well as baseline data, activity targets, beneficiary details, a reporting schedule, and the persons responsible for collecting and disseminating the data.

The primary responsibility for collecting and using monitoring data on a Disaster Assistance Response Team (DART) falls to the planning function, although this responsibility, to a certain degree, applies to all DART Team members. Recommendations for monitoring include making the process highly participatory and decentralizing the use of streamlined tools, to the extent possible, to encourage data integrity.

B. Evaluation

Evaluation may be thought of as the periodic review of program activity outcome and impact, with an emphasis on lessons learned. Evaluations are reflective by nature and take into account performance and beneficiary reach. The results are often used when considering programmatic options and to guide future strategic and funding decisions. In terms of timing, evaluations are typically conducted at the end of a program or midway for programs of long duration. Best practices suggest the following themes be considered when conducting evaluations: relevance, effectiveness, efficiency, impact, coverage, coherence, sustainability, and connectedness/coordination.

Miscellaneous Conversion Information

Celsius to Fahrenheit

$$(\text{Celsius} \times 1.8) + 32 = \text{Fahrenheit}$$

Fahrenheit to Celsius

$$(\text{Fahrenheit} - 32) / 1.8 = \text{Celsius}$$

Weight of Water by Volume (at 16.7° C or 62° F)

1 liter	=	1 kilogram
1 U.K. gallon	=	10 pounds
1 U.K. gallon	=	1.2 U.S. gallons
1 U.K. gallon	=	4.54 liters
1 U.S. gallon	=	0.833 U.K. gallons
1 U.S. gallon	=	8.33 pounds
1 U.S. gallon	=	3.79 liters
1 liter	=	0.26 gallons
1 cubic foot of water	=	62.3 pounds (7.48 gallons)

Distance

$$1 \text{ nautical mile} = 1.152 \text{ statute miles} = 1.852 \text{ kilometers}$$

How To Calculate Area and Volume

$$\text{Area} = \text{Width} \times \text{Length}$$

$$\text{Area of a circle} = \Pi r^2$$

$$\text{where } \Pi = 3.14$$

$$r = 1/2 \text{ the diameter of a circle}$$

$$\text{Volume} = \text{Width} \times \text{Length} \times \text{Height}$$

$$\text{Volume of a cylinder} = \Pi r^2 H \text{ or } \Pi r^2 L$$

$$\text{where: } H = \text{height of cylinder}$$

$$L = \text{length of cylinder}$$

Metric to English Conversion Factors

To convert	into	multiply by
Lengths		
millimeters	inches	0.0394
centimeters	inches	0.3937
meters	inches	39.3700
meters	feet	3.2808
meters	yards	1.0936
kilometers	yards	1093.6133
kilometers	miles	0.6214
Surfaces		
square centimeters	square inches	0.1550
square meters	square feet	10.7639
square meters	square yards	1.1960
square kilometers	square miles	0.3861
hectares	acres	2.4710
Volumes		
cubic centimeters	cubic inches	0.06102
cubic centimeters	liquid ounces	0.03381
cubic meters	cubic feet	35.31467
cubic meters	cubic yards	1.30795
cubic meters	gallons (U.S.)	264.17205
liters	cubic inches	61.02374
liters	cubic feet	0.03531
liters	gallons (U.S.)	0.26417
milliliters	teaspoon	0.20289
milliliters	tablespoon	0.06763
milliliters	fluid ounces	0.03381
liters	cups	4.22675
liters	pints	2.11338
liters	quarts	1.05669
Weights		
grams	grains	15.4324
grams	ounces	0.0353
kilograms	ounces	35.2740
kilograms	pounds	2.2046
kilograms	tons (U.S.)	0.001102
kilograms	tons (long)	0.000984
tons (metric)	pounds	2204.6226
tons (metric)	tons (U.S.)	1.1023
tons (metric)	tons (long)	0.9842

English to Metric Conversion Factors

To convert	into	multiply by
Lengths		
inches	millimeters	25.4
inches	centimeters	2.54
inches	meters	0.0254
feet	meters	0.3048
yards	kilometers	0.0009
yards	meters	0.9144
miles	kilometers	1.6093
Surfaces		
square inches	square centimeters	6.4516
square feet	square meters	0.0929
square yards	square meters	0.8361
square miles	square kilometers	2.5900
acres	hectares	0.4047
Volumes		
cubic inches	cubic centimeters	16.387064
cubic inches	liters	0.016387
cubic feet	cubic meters	0.028317
cubic feet	liters	28.316847
cubic yards	cubic meters	0.764555
liquid ounces	cubic centimeters	29.573530
gallons (U.S.)	cubic meters	0.003785
gallons (U.S.)	liters	3.785412
teaspoons	milliliters	4.928922
tablespoons	milliliters	14.786765
fluid ounces	milliliters	29.573530
cups	liters	0.236589
pints	liters	0.473176
quarts	liters	0.946353
Weights		
grains	grams	0.064799
ounces	grams	28.349523
ounces	kilograms	0.028350
pounds	kilograms	0.453592
pounds	tons (metric)	0.000454
tons (U.S.)	kilograms	907.184740
tons (U.S.)	tons (metric)	0.907185
tons (long)	kilograms	1016.046909
tons (long)	tons (metric)	1.016047